



# FLUID METERING, INC.

## Valveless Metering Pumps and Dispensers



**Over 59 Years of Precision Fluid Control**

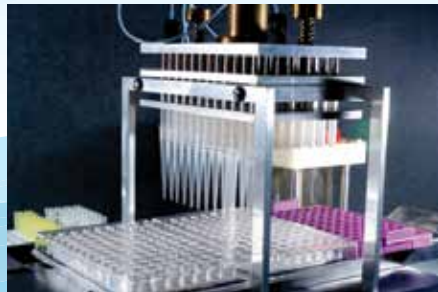



**Solutions  
for:**  
Medical Diagnostic  
Analytical  
Laboratory  
Process  
Industrial  
Instrumentation  
OEM

ISO 9001 : 2015 Certified

**[www.FluidMetering.com](http://www.FluidMetering.com) / 1 800.223.3388**

# Valveless Ceramic Dispensers & Metering Pumps Since 1959!

- No Valves, Drift-Free Operation
- One Moving Part
- Precision Dispensing - CV of 0.5% or better
- Flow Rates from Microliters to 4600 mL/min
- Positive Displacement up to 200 psig
- Viscosity Independent - Unaffected by Viscosity of Fluids
- Millions of Maintenance-Free Cycles
- Inert, Corrosion Resistant Fluid path - Ceramic & Fluorocarbon Standard
- Self-priming to 15 Feet, Vertical Lift
- Instant Reversibility While Running
- Large Selection of Drives - Fixed, Variable, Pneumatic, Stepper, Hazardous Duty and OEM

The valveless pumping function is accomplished by the synchronous rotation  and reciprocation  of the ceramic piston in the precisely mated ceramic cylinder liner. One complete piston revolution is required for each suction /discharge cycle as shown. The piston always bottoms for maximum fluid and bubble clearing.

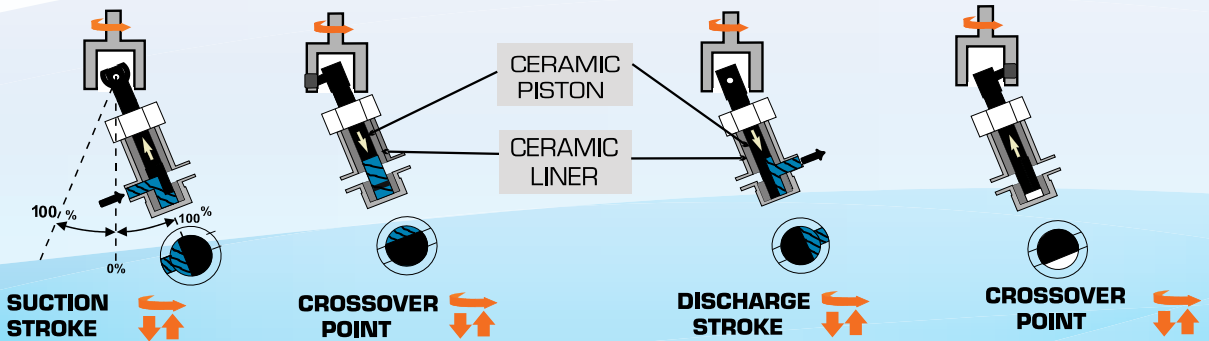

The piston rotates and reciprocates. As the piston is pulled back and the piston flat opens to the inlet port, suction is created and fluid fills the pump chamber. As the piston reaches the highest point in the reciprocation cycle, the pump chamber is now at its maximum volume capacity. Continuing the rotation, the inlet port is then sealed

and crossover occurs. As the inlet port is sealed and the pump chamber is full, the outlet port opens up. **Only one port is open at any time and at no time are both ports interconnected.**

Continuing the rotation and reciprocation, the piston is forced down and the piston flat opens to the outlet port. Discharge is created and fluid is pumped out. The piston bottoms for maximum fluid and bubble clearing. Continuing the rotation, the outlet port is then sealed

and crossover occurs. As the outlet port is sealed and the pump chamber is empty, the inlet port opens to start another suction stroke. **Only one port is open at any time and at no time are both ports interconnected.**

For a video animation of how FMI pumps work, Visit [www.FluidMetering.com](http://www.FluidMetering.com)

## Easy Flow Rate Adjustment

- Moving the pump head position changes the piston stroke length and, in turn, the flow rate
- Infinite fine flow adjustments between zero and 100% flow rate
- Flow rate **Dial Indicator Kit Q485** for the **Q** line provides accurate and simple linear calibration (See page 30)
- Flow rate can be changed while pump is operating or at rest

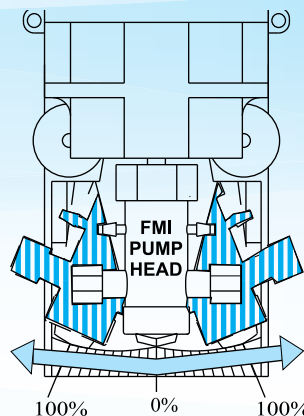

- On the **Q** line this is done by turning the Flow Control Knob which moves the flow rate indicator along a fixed 20 unit scale linearly calibrated "10-0-10". The "10" equals 100% flow rate in that direction, "0" equals zero flow.
- The **RH** line flow adjustment is accomplished by turning an easy-grip Flow Control Ring graduated in 450 divisions from 0 to 100% flow



# Pump Head Codes & Materials

The table below provides codes and prices for all available Pump Head Modules (PHM). After selecting the appropriate Pump Drive Module and Piston Size Code, (refer to Drive Section, pages 6-17) select a PHM and available options below. FMI pump heads are made from various materials of construction for use in most applications. All FMI pumps are modular in design.

The Pump Head Modules can be easily removed for cleaning or replaced with a spare pump head for use with different fluids. Some customers have separate pump heads for use with each fluid handled or flow rate desired. When ordered together, Pump Drive Modules, Pump Head Modules, and options are mounted, tested and shipped as one unit.

## Pump Head Materials Configuration

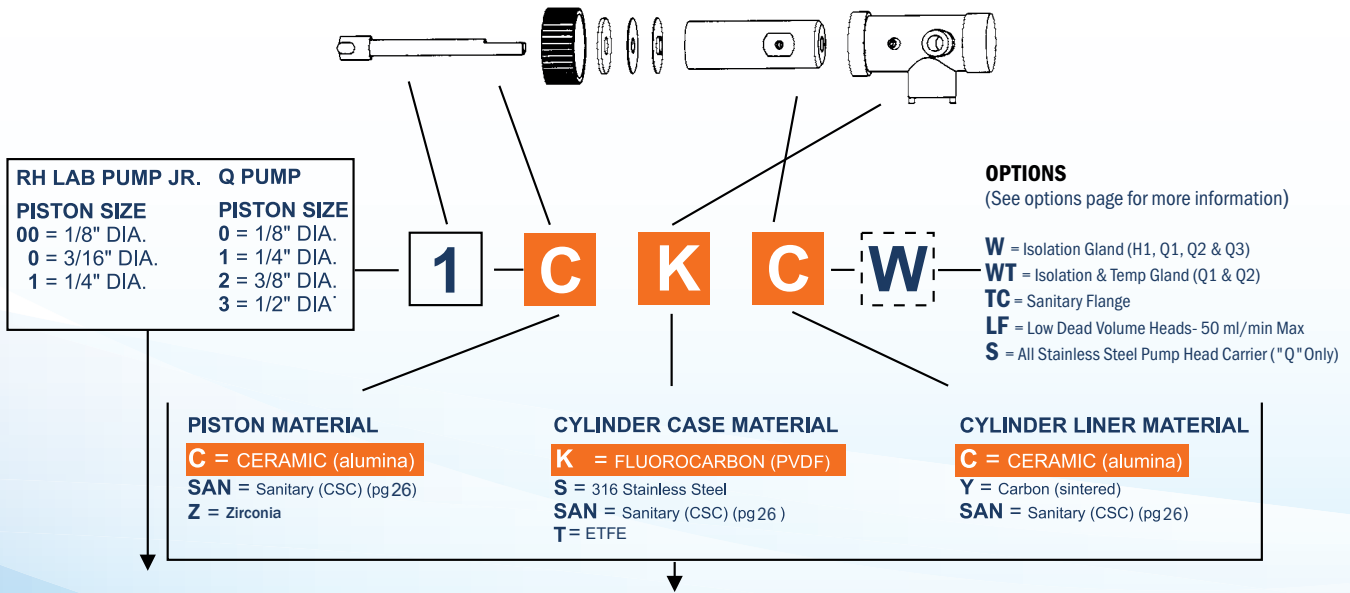

## PHM (PUMP HEAD MODULE)

Piston Size Code	Materials of Construction							
	CKC	CKY	CSC	CSY	SAN	CTC	ZKC	ZTC
RH00								
RH0								
RH1								
Q0								
Q1								
Q2								
Q3								
Wetted Parts	Ceramic PVDF	Ceramic PVDF Carbon	Ceramic 316 SS	Ceramic 316 SS Carbon	Ceramic Teflon	Ceramic Tefzel	Zirconia PVDF	Zirconia Tefzel
MAX.Temp	212° F	212° F	350° F	350° F	350° F	212° F	212° F	212° F
Options								
LF (pg.28)								
W (pg.26)								
WT (pg.26)								
TC (pg.27)								
R479 (pg.30)								
S ("Q" Only)								

Available Modules





# Selection Guide for FMI's Pump Heads



**QCKC**

## QCKC Ceramic & PVDF Fluid Path

- Excellent for general use with acids, caustics and most solvents (not recommended for MEK, Acetone, & Methylene Chloride)
- Rated to 212°F (100° C) operating, 60 psig (4.1 bar), Autoclavable (non-operating) to 240°F (116°C)



**QSANS**

## QSANS Sanitary Design

- Ideal for food, biotech and pharmaceutical applications
- 316SS, Ceramic and PTFE wetted path for excellent chemical resistance
- Easy disassembly for cleaning, no internal threads for 1/4" or 3/8" id tubing



**QCKC-W**

## QCKC -W Flush Gland version of QCKC

- Ideal for air sensitive, crystal forming solutions such as saline
- Isolates main pump fluid from seals and atmosphere



**QSAN-TC**

## QSAN-TC Tri-clamp version of SAN

- Quick connect 1" flange for 1/4" to 1" tubing sizes



**QCSC**

## QCSC 316SS Ceramic & PTFE Fluid Path (standard)

- Excellent Chemical Resistance
- Rated to 350°F (177° C), 100 psig (6.9 bar)



**QCV**

## QCV For water treatment chemicals such as Sodium Hypochlorite and caustic Soda 100°C at 125 psig



**QCSC -W**

## QCSC-W Flush Gland version of QCSC

- Ideal for air sensitive, crystal forming solutions such as saline
- Isolates main pump fluid from seals and atmosphere



**RH**

## RH Small displacement, self contained pump for 1/4" O.D tubing using compression fittings for 0 to 100µl/stroke to 360 mL/min

- Excellent chemical compatibility. Ceramic and PVDF wetted path.
- Fully adjustable zero to max
- 212°F (100° C), autoclaved up to 240°F (116° C) (non-operating), and pressure to 100 psig
- Flow Path: Ceramic and PVDF standard - other materials available (RH00ZTC, RHOCKC, RH1CKC)



**QCSC-WT**

## QCSC-WT "Hi Temp Gland" Pump Heads

- Designed for applications, which require temperature control of the pump head
- Accepts two standard 1" x 1/4" cartridge heaters & a 1/8" dia. thermocouple. Pump head also includes an isolation gland.
- Rated to 350°F (177 C), 100 psig (6.9 bar)
- 316SS, Ceramic, & PTFE fluid path



**RHLF**

## RHLF "Low Flow", Low Dead Volume pump. Female 1/4-28 port version of RH.



**QCSC-200**

## QCSC-200

- 200 PSI high pressure version of QCSC
- For Prep/Flash Chromatography

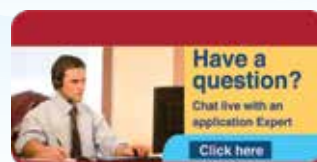

# Select-A-Pump

- Select the flow and pressure closest to your requirements
- Refer to the pages indicated for information on available models
- Flow rates shown are maximum milliliters per minute
- All FMI pumps are infinitely adjustable from zero to their maximum flow rate

**Example**  
15 ml/min  
@ 20 psig

**MAX. FLOW RATES**  
(ML/MIN)

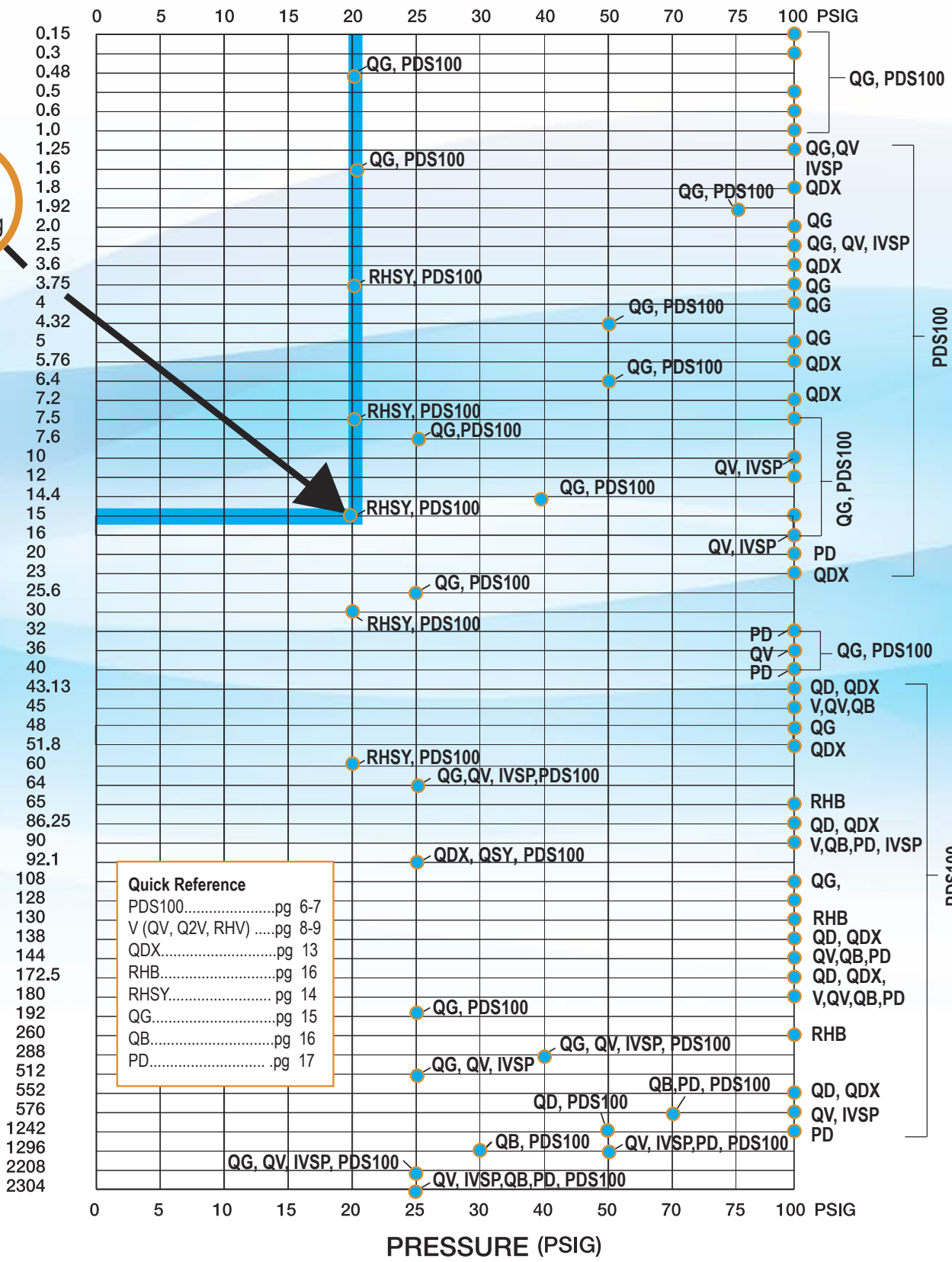

# PDS100 Programmable Dispenser

## Valveless, Programmable, Dispensing & Metering System

The **PDS100** is a precision system capable of dispensing or pumping fluids ranging from 3  $\mu\text{L}$  per dispense or 18  $\mu\text{L}/\text{min}$  continuous (**Single RH00LF**) up to 1536  $\text{mL}/\text{min}$  (**Dual Q3**) into pressures ranging from 10 psi to 100 psi (**RH**).

- All models feature FMI's patented **CeramPump®** No-Valve Fluid Control Technology
- Intuitive menu-driven programming uses front panel membrane switches with 2.75" x 1.5" LCD display
- Pump heads are integrally mounted to control unit, which includes precision stepper motors, drivers and programmable electronics housed in a rugged, anodized, aluminum enclosure
- Available in single and dual pump head configurations in all FMI pump head sizes
- Universal Power Input accepts 100-240 V AC 50/60 Hz
- Ideal for process & production single and dual channel dispensing & filling
- Dual pump head configurations can be programmed for independent pump control, great for proportional flow or dilutions



Selectable RS485, 4-20 mA, 0-5 V DC, and 0-10 V DC input for automatic control

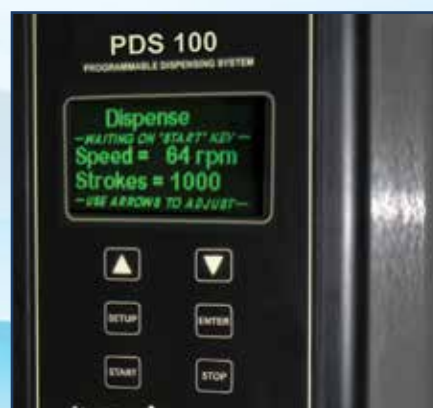

LCD Menu Display & Membrane Switches

Piston Code	Speed (RPM) Standard		Dispense Volume/Revolution		Dispense Rate mL/min (Maximum Stroke)				Pressure (PSIG)	
			Min Dispense (mL/rev)	Max Dispense (mL/rev)	Single		Dual - Pumps In Phase		Single	Dual - 2 Independent "Solo" Pumps Each
	Min (@ Minimum Speed)	Max (@ Maximum Speed)			Min (@ Minimum Speed)	Max (@ Maximum Speed)	Maximum			
RH00	6	750	0.003	0.025	0.0180	18.75	0.036	37.5	100	
RH0			0.003	0.050	0.0180	37.50	0.036	75.0		
Q0		600	0.004	0.080	0.0240	48.00	0.048	96.0	40	
RH1		750	0.005	0.100	0.0300	75.00	0.06	150.0	100	
Q1		600	0.016	0.320	0.0960	192.00	0.192	384.0	40	
Q2			0.036	0.720	0.2160	432.00	0.432	864.0	20	
Q3	0.064		1.280	0.3840	768.00	0.768	1536.0	10		

1) Minimum Flow Rates for RH and Q Pump Heads calculated at 6 RPM

2) Maximum Flow Rates for RH Pump Heads calculated at 750 RPM

3) Maximum Flow Rates for Q Pump Heads calculated at 600 RPM





# PDS100 Programmable Metering Pump

Dispense, Pump, Mix, Dilute, or Proportion



RH



STQP



2STQ



STH



2RH



Foot Pedal

PDS100



**Dimensions:**

11 3/4" x 5 1/8" x 6 1/4" wide  
(300 x 128 x 159 mm)

**Electrical:**

RS485, 4-20 mA, 0-10 V, 0-5 V interface for connection to process sensors, PLC and PC controllers

**Shipping weight:**

7.5 lb. (3.41 kg)



# V Variable Speed Pump

Variable Flow Rate to 2300 mL/min

## QV / QVG50 / Q2V



### QV/QVG50

**Dimensions:**

**QVG50:** 11" x 5" x 5 3/4" wide  
(279 x 127 x 146 mm)

**QV:** 10" x 4 5/8" x 4 7/8" wide  
(254 x 117 x 124 mm)

**Shipping weight:**

QV : 10 lb (4.5 kg)  
V300: 5 lb (2.25 kg)  
QVG50: 10 lb (4.5 kg)



### RATIO:MATIC®

### Q2V

**Dimensions:**

15" x 4 7/8" x 5 1/8" wide  
(381 x 124 x 130 mm)

**Shipping weight:**

Q2V: 15 lb (6.75 kg)  
V300: 5 lb (2.25 kg)

### How to Order

Drive + Pump Head  
QVG50 + Q3CKC = Complete pump

## RHV Low Flow

(0 - 180 mL/min)



- Drift-free flow ranges up to 180 mL/min, pressures from -10 to 100 psig
- Easy grip displacement control ring graduated in 450 divisions

### RHV

**Dimensions:**

8" x 3" x 3" wide  
(181 x 76 x 76 mm)

**Shipping weight:**

RHV: 7 lb (3.15 kg)  
V300: 5 lb (2.25 kg)

**Electrical:**

1800 RPM

### RHV Pumps (Includes V300)

MAX. Flow/Pressure			Wetted Parts	MAX. Fluid Temp	Complete Pump
ML/MIN	PSIG	BAR			
90	100	6.90	Ceramic / PVDF	212° F	RHV0CKC
180	100	6.90	Ceramic / PVDF	212° F	RHV1CKC
45	100	6.90	Zirconia / Tefzel	212° F	RHV00ZTC
90	100	6.90	Ceramic / Tefzel	212° F	RHV0CTC
180	100	6.90	Ceramic / Tefzel	212° F	RHV1CTC



# V Variable Speed Controller

Ideal for Automated Process Control

**V300** Variable Speed Controller **QV, QVG50, RHV** and **Q2V** Pump Drive Modules

- Membrane Switches for manual flow rate settings and start/stop functions
- Selectable 4-20 mA, 0-5 V DC, & 0-10 V DC input for automatic control
- Start, Stop & Reverse Flow while maintaining flow settings
- Rugged, Anodized, Aluminum Enclosure designed for both bench-top & wall mounting



Selectable 4-20 mA, 0-5 V DC, & 0-10 V DC input for automatic control for QV, QVG50, RHV & Q2V Pump Drive Modules



Digital LCD Flow Display



## How to Order

Drive + Pump Head = Complete pump  
 QV + Q3CKC

### QV/QVG50/Q2V PDM (Includes V300)

MAX. Flow		Pressure		PDM	Piston Code
ML/MIN	GAL/HR	PSIG	BAR		
1.25	.019	100	6.90	QVG50	RH00
2.50	.039				RH0
4.00	.063				Q0
5.00	.079				RH1
16.00	.252				Q1
36.00	.568				Q2
64.00	.998	25	1.72	Q3	
45	.71	100	6.90	QV	RH00
90	1.4				RH0
144	2.2				Q0
180	2.8				RH1
576*	9.1				Q1
1296*	20.4				50
2304*	35.9	25	1.72	Q3	
90	1.42	100	6.90	Q2V	RH00
180	2.8				RH0
288	4.4				Q0
360	5.6				RH1
1152*	18.2				Q1
2592*	40.8				50
4608*	71.8	25	1.72	Q3	

### V300

**Dimensions:**  
 7 1/4" x 5 1/8" x 6 1/4" wide  
 (182 mm x 128 x 159 mm)

**Shipping weight:**  
 Q2V: 15 lb (6.75 kg)  
 V300: 5 lb (2.25 kg)

**Electrical:**  
 Universal Power Input accepts  
 100-240 V AC 50/60 Hz

**Drive Options**

- Mounting Base (pg.15) Part # -MB
- Dial Indicator (pg.30) Part # -Q485

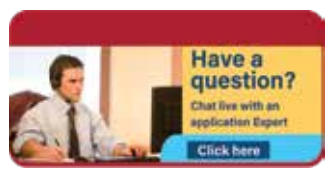

**Have questions?**  
 Chat live with an FMI application specialist at [www.FluidMetering.com](http://www.FluidMetering.com)

\* See General Specifications note (pg 35)



# QP Motorless Pedestal

## High Flow - Rugged Duty

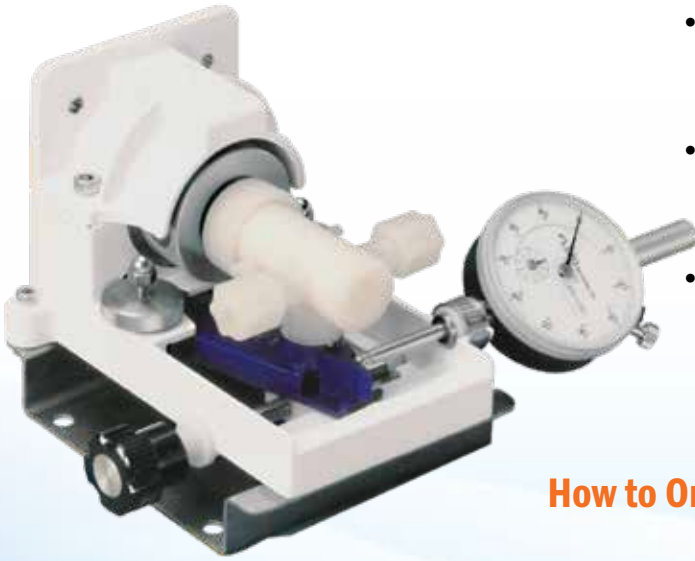

- Typically driven by belt, chain or shaft coupling connected to your special motor drive, e.g. air, hydraulic, stepper, etc. Maximum speed 1800 RPM
- Used extensively in laboratory, industrial, and OEM applications for both dispensing & metering up to 2300 mL/min continuous flow
- Minimal torque requirement of 35 inch ounces

### How to Order

Drive + Pump Head  
QP + Q1CKC = Complete pump

### QP

#### Dimensions:

6 3/8" x 4 3/8" x 5 1/8"  
(162 x 111 x 130 mm)

#### Shaft extension:

5/16" dia. x 1 3/16"  
(8 mm dia. x 30 mm)

#### Shipping weight:

5 lb. (2.25 kg)

### QP PDM (PUMP DRIVE MODULE)

MAX. Flow/Pressure			PDM	Piston Code
ML/Stroke	PSIG	BAR		
.025	100	6.90	QP	RH00
.05				RH0
.08				Q0
.10				RH1
.32				Q1
.72	Q2			
1.28	25	1.72	Q3	



#### Drive Options

Dial Indicator (pg.30) Part # Q485

P56C Face Adapter (pg. 29) Part # - P56C

Masterflex™ Adapter (pg. 29) Part # - RH/M

## QP56C - Use your own 56C Motor



- Use your own 56C Motor ( 5/8" shaft diameter )
- Maximum speed 1800 RPM

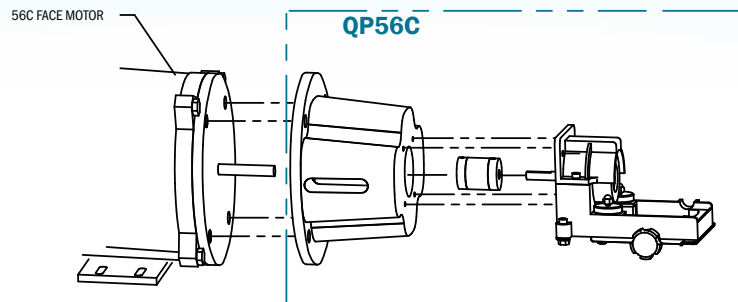

### QP56C



# RH Miniature Motorless

Low Flow - High Precision

- 0 to 100 microliters per stroke
- Precision stroke to stroke = 0.5% or better
- Pressures from -10 to 100 psig
- Needs only 17 inch ounces of torque
- Requires only 2 1/4" panel space
- Accommodates standard 1/4" O.D. tubing or 1/4-28 low flow fittings
- 0 to 100% stroke length adjustment for maximum flow rate flexibility while running or at rest
- Linear speed vs. flow rate from 0 to 3600 RPM (360 mL/min)
- Ceramic and PVDF standard wetted materials - also available in Tefzel®

Actual Size



## RHLF

**RH-LF** features integrally molded 1/4-28 female low dead volume ports. This allows for quick connections to 1/16" & 1/8" O.D. micro bore tubing and fittings (FMI Q661 pg. 28).

**Dimensions:**  
2 1/4" O.D. x 3 1/2"  
(57 O.D. x 89 mm)

**Shaft Extension:**  
5/16" dia. x 3/4" long  
(8 mm dia. x 19 mm long)

**Shipping weight:** 2 lb (0.9 kg)

## RH Pumps

MAX. Flow/Pressure			Wetted Parts	Complete Pump Assembly
ML / Stroke	PSIG	BAR		
0 - 0.025	100	6.90	Zirconia / Tefzel / Ceramic	RH00ZTC
0 - 0.05	100	6.90	Ceramic / PVDF	RH0CKC
0 - 0.10	100	6.90	Ceramic / PVDF	RH1CKC

### Drive Options

Masterflex Adapter (pg. 29) Part #: - RH/M

Adapter for Q (PDM) (pg. 29) Part #: - RH/Q

Low Dead Volume Pump Head (pg. 28)  
Part #: - LF for 1/4-28



Actual Size



## RH

**RH** features integrally molded compression fittings sized for standard 1/4" O.D. tubing



### RH/Q Adapter

See page 29



### OEM Version

See page 21





# QD High Speed - High Flows

For General Lab and Industrial Use



- Flow rate infinitely adjustable from 0 to 2208 mL/min in either direction
- No valves to clog, hang up or service
- Ceramic and fluorocarbon standard wetted materials
- Drift-free performance
- Convenient multi-position tilt stand for wall or counter mounting
- Rugged, long life, fan cooled, thermally protected, ball bearing motor

QD

#### Dimensions:

9 3/4" x 4 3/4" x 5 3/8"  
(248 x 121 x 137mm)  
Shipping weight:  
10 lb (4.5 kg)

#### Electrical:

115 V AC, 60 Hz, 1Ø,  
1.25 amps, 1/25 HP,  
1725 RPM, shaded  
4 pole, TEFC, sparkless,  
thermally protected with  
3 prong power cord.  
Motor is UL recognized

**How to Order** Drive + Pump Head = Complete pump  
QD + Q3CKC

#### QD/QDX PDM (PUMP DRIVE MODULE)

MAX. Flow/Pressure				PDM	Piston Code
ML/MIN	GAL/HR	PSIG	BAR		
43.13	0.681	100	6.90	QD	RH00
86.25	1.3				RH0
138.0	2.1				Q0
172.50	2.7				RH1
552*	8.6				Q1
1242*	18.9	50	3.45	Q2	
2208*	30.0	25	1.72		Q3

\* See General Specifications note (pg 35)

#### Drive Options

230 VAC (50/60 Hz)* Part # -2
Mounting Base (pg.15) Part # -MB
Dial Indicator (pg.30) Part # Q485
Hazardous Duty (pg.13) Part #: QDX

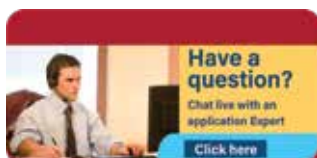

#### Have questions?

Chat live with an FMI application specialist at [www.FluidMetering.com](http://www.FluidMetering.com)



# QDX Hazardous-Duty Drive

- Flow rate infinitely adjustable from 0 to 2208 mL/min variable in either direction 100 psi
- High flow hazardous-duty motor Class I, Group C, D Class II, Group E, F, G
- Rugged, long life, fan cooled, thermally protected, ballbearing motor
- Fixed Speed

### Electrical:

115/230 V AC, 60 Hz, 1Ø, 1/3 hp, ball bearing, UL listed & CSA certified motor, 1725 RPM, pigtail leads for conduit connection. Motor is totally enclosed, fan cooled. 6.6 amps @ 115 V AC and 3.3 amps @ 230 V AC



### QDX

### Dimensions:

17 3/4" x 6 7/8" x 8 1/2" wide  
(451 x 175 x 216 mm)

### Shipping weight:

43 lb (19.35 kg)

## QP56C - Use your own 56C Motor



### QP56C

- Use your own 56C Motor
- Max 1800 RPM

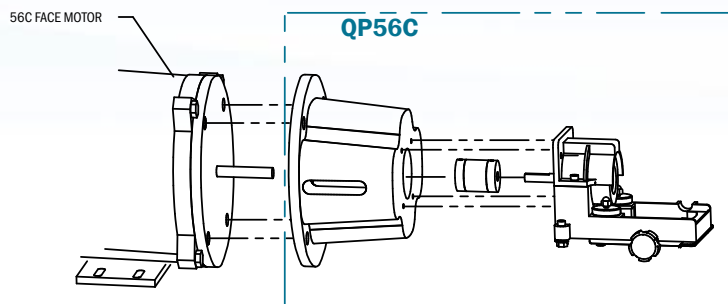

# Small Solutions

## RHSY Synchronous Pumps

The Ultimate in Low Flow Metering Accuracy



- Compact design **RH** pump with synchronous motor assembly
- Drift-free performance independent of load variations or fluctuations in line voltage
- Micrometer-like fine adjustment using an easy grip flow control ring graduated in 450 divisions
- Choice of 150, 300, and 600 RPM through a simple and safe belt arrangement change
- Forward - Off - Reverse switch for instant flow direction control

### RHSY

#### Dimensions:

5" x 5" x 4" wide  
(127 x 127 x 102 mm)

#### Shipping weight:

4 lb (1.8kg)

#### Electrical:

115 V AC, 60 Hz, 1Ø,  
.08 amps, with 3 prong  
power cord

### RHSY Pumps

MAX. Flow			Wetted Parts	MAX. Fluid Temp	Complete Pump
@150 RPM mL/min	@300 RPM mL/min	@600 RPM mL/min			
7.5	15.0	30	Ceramic / PVDF	212° F	RHSY0CKC
15.0	30.0	60			RHSY1CKC



#### Drive Options

230 VAC (50Hz., .04 amp) \* Part # -2

Note: Flow Rates are reduced approximately 18% when Pump Drive Module is operating on a 50 Hz electrical supply.

## PiP Precision Dispenser

Pipetting, Syringing and Diluting

- Ideal for repetitive and volumetric dispensing of acids, solvents and aqueous solutions
- Can act as a single shot dispenser using the hand/foot switch or as a single metering pump in the continuous mode
- Using a combination of forward and reverse modes, dilutions can easily be accomplished

### PiP

#### Dimensions:

5" x 5" x 4" wide  
(127 x 127 x 102mm)

#### Shipping weight:

5 lb (2.25 kg)

#### Electrical:

115 V AC, 60 Hz, 1Ø, .08 amps,  
150, 300, 600 RPM with 3  
prong power cord

### PiP Pumps micro π-petter®

MAX. Dispense Rates	Complete Pump Assembly
Microliters / Revolution	
0 - 50 µL	PIPOCKC
0 - 100 µL	PIP1CKC



#### Drive Options

Low Dead Volume Pump Head  
(pg. 28) Part # - LF for 1/4-28





# QG Low Speed - Low Flows

For General Lab and Industrial Use

- A choice of five different drive speed models
- Ceramic and fluorocarbon standard wetted materials
- Long-life, fan cooled, thermally protected, ball bearing gear motors
- Convenient multi-position tilt stand for wall or counter mounting
- Can be combined with all **RH** and **Q** Pump Head Modules
- Flow rate infinitely adjustable from 0 to maximum in either direction
- **Note:** The **QG6-3**, **QG6-3MB**, **QG50-3MB** and **QG50-3MB** configurations are no longer available

**How to Order** Drive + Pump Head  
QG + Q3CKC = Complete pump

## QG PDM (PUMP DRIVE MODULE)

MAX. Flow		Pressure		PDM	Piston Code		
ML/MIN	GAL/HR	PSIG	BAR				
0.15	.002	100	6.90	QG6	RH00		
0.30	.004				RH0		
0.48	.007	20	1.38		Q0		
0.60	.009	100	6.90		RH1		
1.92	.030	75	5.17		Q1		
4.32	.068	50	3.45		Q2		
7.68	.119	25	1.72		Q3		
0.50	.007	100	6.90	QG20	RH00		
1.00	.015				RH0		
1.60	.025	20	1.38		Q0		
2.00	.031	100	6.90		RH1		
6.40	.101	50	3.45		Q1		
14.40	.227	40	2.76		Q2		
25.60	.399	25	1.72		Q3		
1.25	.019	100	6.90	QG50	RH00		
2.50	.039				RH0		
4.00	.063				Q0		
5.00	.079				RH1		
16.00	.252				Q1		
36.00	.568				Q2		
64.00	.998				25	1.72	Q3
3.75	.059	100	6.90	QG150	RH00		
7.50	.118				RH0		
12.00	.189				Q0		
15.00	.237				RH1		
48.00	.758				Q1		
108.00	1.706				50	3.45	Q2
192.00	2.995				25	1.72	Q3
10.00	.158	100	6.90	QG400	RH00		
20.00	.316				RH0		
32.00	.505				Q0		
40.00	.632				RH1		
128.00	2.022				Q1		
288.00*	4.550				50	3.45	Q2
512.00*	7.987				25	1.72	Q3

c  us 



### Drive Options

230 VAC (50/60 Hz)\* Part # -2

24 VAC (50/60 Hz)\* Part # -3

Mounting Base (pg.15) Part # -MB

Dial Indicator (pg.30) Part # Q485

**QG**

### Dimensions:

10 3/4" x 4 7/8" x 5 3/4" wide  
(273 x 124 x 146 mm)

### Shipping weight:

10 lb (4.5 kg)

### Electrical:

115 V AC, 60 Hz, 1Ø, 1 amp, 6, 20, 50, 150, 400 RPM, shaded 2 pole, enclosed ventilated, thermally protected, 135°C with 3 prong power cord

c  us 

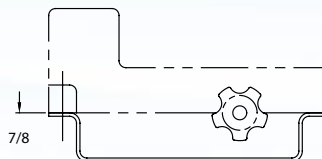

### "Q" Fixed Mounting Base KIT MB

Sturdy mounting base accessory for "Q" Line metering pumps. The "Q" mounting base allows pumps to be firmly bolted to surface in horizontal or vertical operating position. Hardware for attaching base to pump and instructions included.

Note: Flow Rates are reduced approximately 18% when operating on a 50 Hz electrical supply.

\*See General Specifications note (pg 35)

• 516-922-6050 • 800-223-3388 • pumps@fmipump.com • www.FluidMetering.com



# RHB / QB Direct Current Pumps

For Mobile, Remote & Instrumentation



- 12, 24, and 90 V DC motors with close-coupled **RH/Q** Pump Heads
- Widely used to inject discrete quantities of additive fluids into main discharge lines of tank trucks and pest control vehicles
- Ideal for environmental sampling & injection
- Offers the advantage of mechanical adjustment of stroke length, plus electrical control of stroke rate by voltage variation
- Extended motor shaft accepts FMI **HES/PRS Rotational Sensors** or user supplied rotational sensor (see page 28 for more info)

## RHB

### Dimensions:

8" x 3" x 3" wide  
(203 x 76 x 76 mm)

### Shipping weight:

7 lb (3.15 kg)

### Electrical:

12 V DC, 4 amps, 2600 RPM, totally enclosed, with 6" pigtail leads  
Shaft extension: 5/16" dia. x 1" long with flat

## RHB Pumps

MAX. Flow	Pressure		Wetted Parts	MAX. Fluid Temp	Complete Pump
	ML/MIN	PSIG			
130	100	6.90	Ceramic / PVDF	212° F	RHBOCKC
260	100	6.90	Ceramic / PVDF	212° F	RHB1CKC



## QB

QB PUMPS: Rated at 1800 RPM (or approximately 8 volts for 12 V DC models)

### Dimensions:

10 1/2" x 5" x 4 1/2" wide  
(267 x 127 x 114 mm)

### Shipping weight:

8 lb (3.6kg)

### Electrical:

12 V DC, 4 amps; 24 V DC, 3 amps; 90 V DC, 0.41 amps, totally enclosed with 6" pigtail leads  
Shaft extension: 5/16" dia. x 1" long with flat



### Drive Options

24 VDC (3 amps) for RHB Part # -4

90 VDC (0.41 amps) for RHB Part # -5

## How to Order

Drive + Pump Head  
QB + Q1CKC = Complete pump

## QB PDM (PUMP DRIVE MODULE)

MAX. Flow/Pressure			PDM	Piston Code
ML/MIN	PSIG	BAR		
45	100	6.90	QB	RH00
90				RH0
144				Q0
180				RH1
576*	70	4.38		Q1
1296*	30	2.07		Q2
2304*	25	1.72	Q3	

\*See General Specifications note (pg 35)



### Drive Options

Mounting Base (pg.15) Part # -MB

Dial Indicator (pg.30) Part # Q485

24 VDC (3 amps) Part # -4

90 VDC (0.41 amps) Part # -5



# PD Pneumatic

## For Non-Electric Operation

- Provides a compact, variable speed, air powered drive
- Ideal power alternative when electrical power source not available
- SPD up to 1800 RPM
- GPD up to 400 RPM (See page 15 QG400 for flow rate data)



**How to Order** Drive + Pump Head  
 SPD + Q1CKC = Complete pump



**Dimensions:**

8" x 3" x 3" wide  
 (203 x 76 x 76 mm)

**Specification:**

**SPD:** Air requirements  
 9-10 CFM at 40 psig  
 Air Inlet size: 1/8" (F) NPT  
**GPD:** Heavy-duty gear box  
 Air requirements:  
 14-16 CFM at 40 psig  
 Air Inlet size: 1/8" (F) NPT

**Shipping weight:**

9 lb (4.05 kg)

### SPD PDM (PUMP DRIVE MODULE)

MAX. Flow/Pressure			PDM	Piston Code
ML/MIN	PSIG	BAR		
45	100	6.90	SPD	RH00
90				RH0
144				Q0
180				RH1
576*	70	Q1		
1296*	50	3.45		Q2
2304*	25	1.72		Q3



Drive Options
Dial Indicator (pg.30) Part # -Q485
Pulse Suppressor (pg.31) Part # 58003

\*See General Specifications note (pg 35)

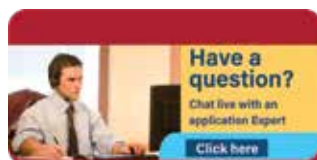

Have questions?  
 Chat live with an FMI  
 application specialist at  
[www.FluidMetering.com](http://www.FluidMetering.com)





# Solutions for All Your OEM Applications



# Production - OEM - LAB

## One Dispenser / Pump For **All** Your Applications

### Valveless Syringing Aspirate & Dispense



### Fast Prime Flush & Wash



0-2,000 ml/min

### Continuous Dispensing

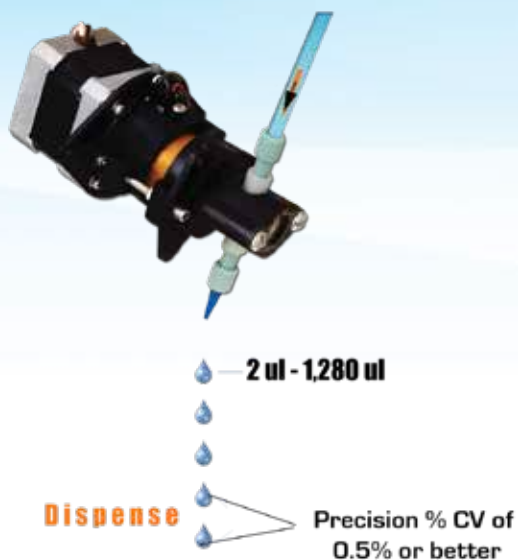

### Continuous Metering

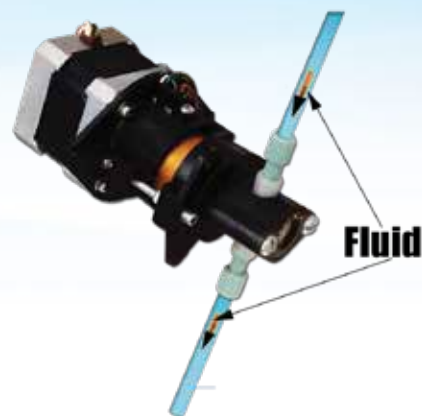

0-2,000 ml/min



# Production - OEM - Lab



**STRH**

## STRH Adjustable Low Flow Stepper Pump

**Meter, Dispense, Aspirate, Flush**

- Precision **RH** adjustable pump with stepper motor
- Valveless, reversible, self priming
- Ceramic and fluorocarbon, low dead-volume fluid path
- Ideal for prototyping
- Optical sensor

MAX. Dispense Rates Microliters / Revolution	Wetted Parts	Complete Pump Assembly
0 - 25 µL	Zirconia / PVDF / Ceramic	<b>STRH00ZKCLF</b>
0 - 50 µL	Ceramic / PVDF	<b>STRH0CKCLF</b>
0 - 100 µL	Ceramic / PVDF	<b>STRH1CKCLF</b>



**STQP**

## STQP Adjustable High Flow Stepper Pump

- Precision, variable displacement **Q** Pump with integral stepper motor
- Accommodates all **Q** style pump heads and **RH** pump heads (with **RH/Q** adapter)
- Ideal for OEM applications where accurate & frequent displacement changes are expected
- Available in **ST2QP Duplex Ratio:Matic®** configurations
- Ideal for prototyping
- Can be driven by FMI's **ICST-02**, or a variety of commercially available stepper driver boards

## ICST-02 Stepper Control

- Programmable control for all FMI Stepper Pumps
- Extensive dispense & metering capabilities
- Multiple input and output connections
- RS 232 Serial Port for PC connection
- MS Windows® programming software included
- Compact size: 2.0" x 3.1" x 1.6" high (51 x 79 x 41 mm)

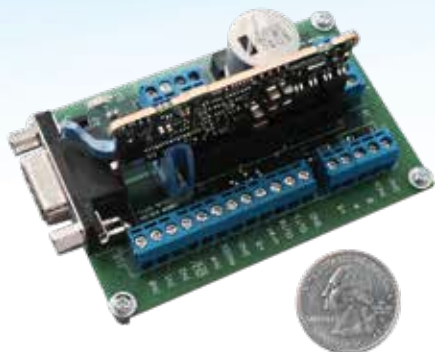

**ICST-02**





# OEM Dispensers / Pumps

## High Precision Stepper Motor Pumps for OEM Applications

- Ceramic and fluorocarbon fluid path
- Displacement of 0 to 1280 microliters (1.28 mL) per revolution
- Excellent chemical resistance
- 1.8° stepper motors with opto sensors



**STH**

### Low Flow **STH**

MAX. Dispense Rates Microliters / Revolution	Wetted Parts	Complete Pump Assembly
0 - 25 µL	Zirconia / PVDF / Ceramic	STH00ZKCLF
0 - 50 µL	Ceramic / PVDF	STH0CKCLF
0 - 100 µL	Ceramic / PVDF	STH1CKCLF
0 - 200 µL	Ceramic / PVDF	STH2CKC

### High Flow **STQ**

MAX. Dispense Rates Microliters / Revolution	Wetted Parts	Complete Pump Assembly
0 - 320 µL	Ceramic / PVDF	STQ1CKC
0 - 720 µL	Ceramic / PVDF	STQ2CKC
0 - 1280 µL	Ceramic / PVDF	STQ3CKC

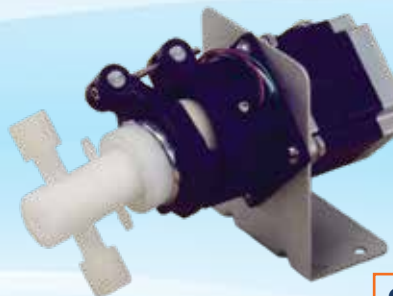

**STQ**



**BDC**

## Brushless DC Pump

### Instrumentation Pump for Wash & Fluid Transfer

- 24 V brushless DC motor
- Fixed displacement, factory calibrated to your specifications
- Compact design with integral electronics

## Sub-1 Pump

### Sub-Microliter Dispensing Pump

- Patent pending Adjustable Dual Eccentric bushings for precise flow calibration
- Dispense volume as low as 1 µL / stroke
- Four pump heads available



**Sub-1**

# OEM Dispensers / Pumps



**STF1-9**

## STF1-9 Valveless 400µL Dispensing Pump

Ideal for OEM Metering & Dispensing Applications

- Compact design
- Larger piston allows higher dispense / metering rate
- 9 pump drives and 4 pump heads - 36 possible configurations



**STF**

## STF Fixed Displacement Pump

Ideal for waste, wash, and flush fluid control in medical instrumentation

- Economical design with fixed displacement link
- Precision stepper motors with opto sensors
- Available in 25µL, 50µL, 100µL, & 200µL versions or custom
- Isolation gland available for crystallizing fluids



**STH2**

## STH2 200µL STH Pump

Ideal for reagent dispensing in clinical chemistry applications

- Extended dispense and flow range in a compact OEM design
- Precision, high-torque stepper with opto sensor
- High performance, extended-life, seal configuration



**H-W**

## H-W Isolation Gland Pump

Miniature OEM pump with isolation gland ideal for low volume fluid control of crystal forming fluids

- Easily handles saline, slurries, particulates and abrasives
- Isolates main process fluid from seal area & atmosphere
- Barbed fittings provide quick connections to gland ports

Isolation  
Gland Port



# Ratio:Matic® Duplex Stepper Pumps

For Proportional and Dual Channel Dispensing and Metering

## ST2RH Low Flow Adjustable

Ideal for high throughput production dispensing in the manufacture of disposable medical components

- Dual variable displacement **RH** pumps with integral stepper motor
- Each pump head is independently adjustable using easy-grip flow control ring
- Ideal for precision low volume dispensing of solvents, adhesives, lubricants, electrolytes, and more
- **Ratio:Matic**® proportional dispensing of ratios up to 100:1



ST2RH

## ST2H Low Volume Fixed Displacement

Compact, dual channel fluid control ideal for OEM medical & analytical instrumentation

- Fixed displacement for dual channel or proportional fluid control
- Proportional fluid control ideal for mixing and diluting
- Each pump head individually factory calibrated to your specifications
- Accommodates all combinations of **H** piston sizes for dispense ratios up to 100:1



ST2H

## ST2QP High Flow Adjustable

- Dual **STQP** high flow pump heads for proportional metering using a single stepper motor
- Each pump head displacement is independently field adjustable
- Accommodates all combinations of **Q** pump sizes

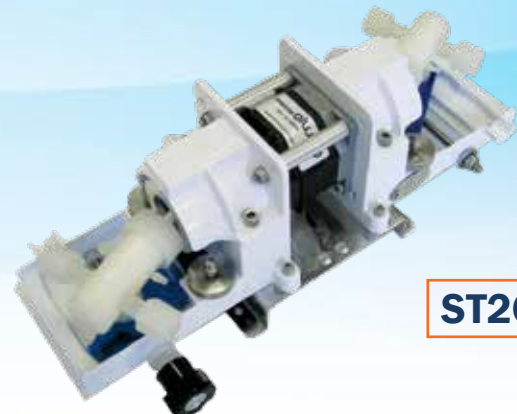

ST2QP

## ST2Q Fixed Displacement

- Dual **STQ** high flow fixed displacement pump heads for proportional metering using a single stepper motor
- Each pump head displacement is factory calibrated

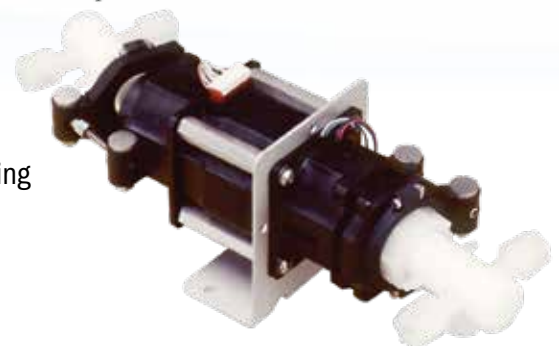

ST2Q



# Specialty Pumps

## Intelligent Programmable Pump



- FMI's **STH Stepper Pump** with integral programmable driver
- Driver provides servo control of a stepper pump
- 5 programmable inputs, 2 programmable outputs
- Multiple programming platforms including Visual Basic, C/C++, Delphi, Lab VIEW
- Analog 0-5 V, RS-232 serial , CANopen protocol supported

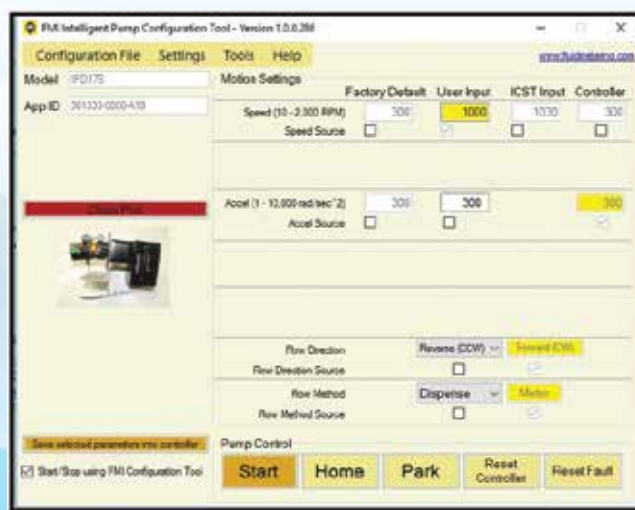

## CL1, CL2 CHLORITROL

### Valveless Hypochlorite Injection

#### The Pump that Never Loses Prime!

The Chloritrol is the solution for sodium hypochlorite injection. Totally new patented technology & field tested, perfect for high and low demand applications, including Ultra Low Volume.

### CL1, CL2

**Dimensions:**  
15 1/2" x 13 3/8" x 6 3/4"

**Shipping weight:**  
18.6 lbs. (8.4 kg)  
Electrical: 0-90 V DC



- No valves or diaphragms to service
- No loss of prime... Ever!
- Ability to prime against 125 psi line pressure
- Months of "no touch" service = fast payback
- Low energy consumption
- Protective enclosure, space-saving wall mount design
- **C100A** Variable speed DC controller accepts 4-20 mA control signal



# Specialty Pumps

## PDS100 Smooth-flo

### Valveless Pulse-Free Dispensing & Metering System

The Smooth-flo **PDS100** is a unique valveless dispensing and metering system which utilizes dual FMI pumps, precisely synchronized, to eliminate pulsation typically present in other piston pump designs.



- Pulse-Free fluid delivery down to 15 µL/min continuous flow
- Precision dual stepper control, factory calibrated for your flow range
- RS485, 4-20 mA, 0-5 V, 0-10 V electronic control interface for connection to process sensors, PLC and PC control systems
- Rugged, anodized aluminum enclosure is suitable for wall mounting or bench top installations
- Includes tubing, fittings, and configuration instructions for Smooth-flo operation
- Universal Power Input accepts 100-240 VAC, 50/60 Hz



### PDS100 SFSTH

**Dimensions:**  
7 1/4" x 5 1/8" x 6 1/4" wide  
(182 x 128 x 159 mm)

**Electrical:**  
RS485, 4-20 mA, 0-10 V, 0-5 V interface for connection to process sensors, PLC and PC controllers

### PDS100 SF Smooth-flo

Dispensing (mL/Rev.)	Metering (mL/min.)	MAX. Flow/Pressure		PDM	Piston Code
		PSIG	BAR		
Min. <sup>1</sup> - Max. <sup>2</sup>	Min. <sup>3</sup> - Max. <sup>4</sup>			PDS-100 SF	RH00
.0025 - 0.050	0.015 - 10	60	4.12		RH0
0.005 - 0.10	0.03 - 20	20	1.38		Q0
0.008 - 0.160	0.048 - 32	60	4.12		RH1
0.01 - 0.20	0.06 - 40	20	1.38		Q1
0.032 - 0.64	0.192 - 128				Q2
0.072 - 1.44	0.432 - 288				Q3
0.128 - 2.56	0.768 - 512				

- 1) Minimum dispense volume per rev. is the total output for 2 identical pumps set at 5% of maximum displacement
- 2) Maximum dispense volume per rev. is for 2 identical pumps set at maximum displacement
- 3) Minimum continuous flow rate is the total output for 2 pumps set at 5% of maximum displacement operating at 6 RPM
- 4) Maximum Flow Rate is for 2 identical pumps set at maximum displacement at 200 RPM

Pulsation reduced 92 - 96% for **Q** Pump Heads and 93 - 96% for **H** Pump Heads.  
Example: Pulsation for a **PDS-100** with **Q1** Pump Heads at 150 RPM is reduced by 97%.



### PDS100 SFSTQ



# Pump Heads

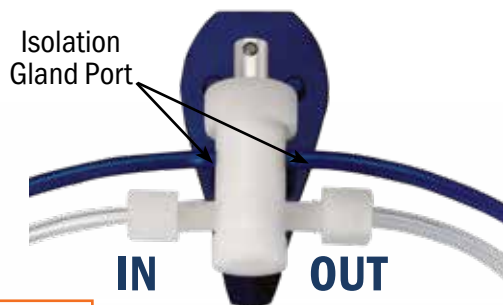

**CKCW**

## W, WT Isolation Gland Pump Heads

- For saline, slurries, abrasives, particulates, anaerobics, and crystal forming fluids. For temperature to 212° F
- Isolates main pumped fluid from seal area and atmosphere
- 2 extra ports for gland “barrier” - liquid or gas
- For **Q1/Q2CKC**, **Q3CKC**, & **CSC** Pump Head Modules

## H-W Isolation Gland Pump Heads

- Easily handles saline, slurries, particulates and abrasives
- Isolates main process fluid from seal area & atmosphere
- Barbed fittings provide quick connections to gland ports

**H-W**



**CSC-W**

## CSC-W Stainless Steel

- Gland design temperature to 350° F
- Pressure to 100 psig
- Ceramic piston and liner in 316SS case
- Main flow 1/4" NPT female; Gland ports: 10-32 female

## SAN Sanitary Pump Heads

- Ideal for accurate and dependable handling of discrete fluid streams in sanitary applications
- No internal threads or blind holes to harbor bacterial growth
- Easily dismantles for scrubbing, brushing, & sterilization
- 316 SS and Teflon® fluid surfaces highly resistant to chemical and biological attack
- Ideal for food, dairy, brewery, pharmaceutical & biotech applications
- Tri-Clamp Flange Kit (see page 29 for more info)

**SAN-S**

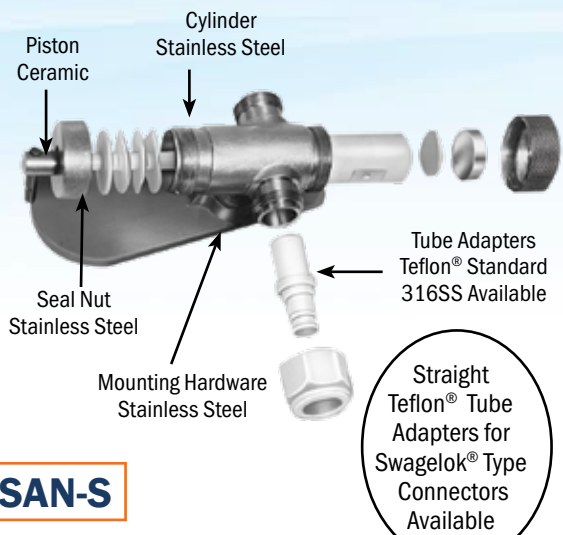

DESIGNED FOR QUICK DISASSEMBLY  
FOR MAXIMUM CLEANING

**ALL STAINLESS STEEL VERSION AVAILABLE WITH SS  
PORT NUTS, TUBE ADAPTERS & CARRIER - "SAN-S"**



# Pump Heads

## **SAN-TC** Tri-Clamp Sanitary Pump Head

- **SAN** Type Sanitary Pump Heads with 316 SS Tri-Clamp flange fittings
- Tri-Clamp fittings are an industry standard for applications which require “quick-connect” fittings for easy sanitizing and/or sterilization
- 1" Flange will accommodate both 1/2" and 3/4" standard tube sizes
- Ideal for food, beverage, biotech, and pharmaceutical process applications



**SAN-TC**

## **Q1CSC-200** 200 PSI **Q** Pump Head

- Increases the operating pressure up to 200 psi for applications requiring flow rates up to 500 mL/min (Consult factory for drive selection)
- Ideal for medium pressure liquid chromatography
- New, high performance, extended-life seal configuration



**Q1CSC-200**

## **CSC-WT** High Temperature

- For maintaining process fluid temperatures and pumping viscous fluids
- High temperature to 350°F
- Accepts 2 standard 1/4" x 1" cartridge heaters & thermocouple
- Pressure to 100 psig
- Ceramic piston and liner in 316 SS cylinder case
- Main flow 1/4" NPT female ports; Gland Ports 1/8" NPT female



**CSC-WT**

## **Q1CV & Q2CV** PVC Pump Head

- Offers superior chemical resistance for metering concentrated water treatment chemicals
- Extended pressure range of 125 psi
- Wetted parts of ceramic and PVC



**Q1CV, Q2CV**

# Options

## LF 1/4-28 Low Flow Pump Heads



- For low flow (under 50 mL/min), and zero dead volume applications
- Direct connection to 1/4-28 low flow fittings
- **RH-LF & Q-LF\*** pump heads feature integrally molded 1/4-28 female low dead volume ports. This allows for quick connections to 1/16" or 1/8" O.D. micro bore tubing and fittings such as **FMI Q661**.
- Add suffix "LF" after Pump Head configuration

\* polypropylene case

## Q661 Small Bore Tubing Kit



- 1/4-28 Fittings and 1/16", 1/8" O.D. Teflon Tubing
- Designed for all LF Pump Heads and to complement the **FMI R479** and **R412-5K**, the Small Bore Tubing Kit has a flangeless design that eliminates the need for special tools and assures leak-free, zero dead volume connections.
- Tefzel® and Teflon® wetted surfaces

**Kit Q661A Delrin (Black) - 1/16"**  
10' - 1/16" O.D. x 1/32" I.D. TFE tubing  
10 - Delrin Nuts (Black)  
10 - Tefzel Ferrules (Blue)

**Kit Q661B Delrin (Green) - 1/8"**  
10' - 1/8" O.D. x 1/16" I.D. TFE tubing  
10 - Delrin Nuts (Green)  
10 - Tefzel Ferrules (Yellow)

**Kit Q661C TFE (white) - 1/8"**  
10' - 1/8" O.D. x 1/16" I.D. TFE tubing  
10 - Teflon Nuts (White)  
10 - Tefzel Ferrules (Yellow)

**Kit Q661 Delrin - 1/16" & 1/8"**  
Contains both Q661A & Q661B

## Hall Effect Electrical Specification



Hall Effect Sensor

PART NO.	Supply Voltage (VDC)	Supply Current (mA max.)	Output Type	Output Voltage (V)	Output Current (Max.)	6" Leadwires
HES-6	4.5 TO 24	10.0	Sink	0.4	40mA	22 gauge teflon insulated

Life: Indefinite

Order : **HES-6**

## Proximity Type Rotational Sensor



PART NO.	FORM	CONTACT RATING	MAX RPM
PRS-1	SPST-N.O.	10 Watts, Max.	1000

Life: 50 Million Operations at 5 VDC, 10 mA

Order : **PRS-1**



# Accessories

## QP/M & RH/M FMI Masterflex® Kits

Enhance your Existing Masterflex Pump Drives

- Move to state-of-the-art valveless piston technology
- Extend operating pressure to 100 psig
- Improve your long term Performance
- Add precise mechanical flow adjustment to your L/S™ drives
- Ceramic and fluorocarbon standard wetted materials
- Installs in minutes to your L/S™ standard pump head, L/S™ EASYLOAD™ pump head, or directly to any L/S™ drive
- Flow rates from microliters to 768 mL/min

Masterflex- Reg TM of Cole-Parmer Instrument Co.  
L/S - Reg TM of Cole-Parmer Instrument Co.  
EASY-LOAD - Reg TM of Cole-Parmer Instrument Co.

Order: **KIT # QP/M or RH/M**



**QP/M**



**RH/M**

## QP56C Adapter Kit

- Adapter Kit for easy hook-up to your NEMA 56C FACE Foot Mount motor
- Kit includes **Pump Drive Module QP**, adapter, coupling and hardware

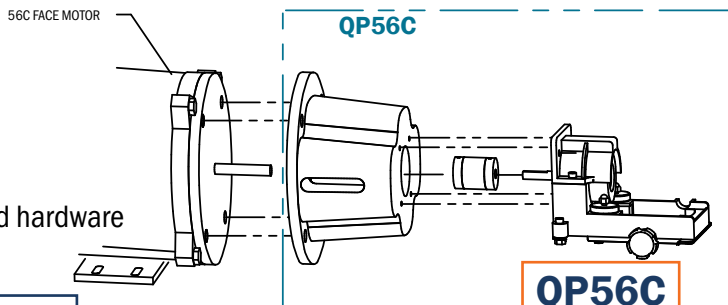

Order: **KIT # QP56C**

## RH/Q Adapter

- Adds versatility to your **RH** pump head by adapting it to any **Q** pump drive
- Simple installation of adapter to **RH** pump head using only 3 screws
- Pump assembly can easily be slipped onto the Drive Module in seconds without tools



**RH/Q**

Order: **KIT # RH/Q**

## Tri-Clamp Sanitary Pump Heads

- Easily changes barbed fittings supplied with **SAN** to **SAN-TC** type
- 1" Flange will accommodate both 1/2" and 3/4" standard tube sizes
- Kit consists of 316 SS Tri-Clamp flange and Teflon port seal



Order: **KIT # 400576** (Q1 & Q2)  
**KIT # 400577** (Q3)



# Accessories



## R479 Low Flow Isolation Kit

- Low flow adapter for stainless steel **Q** pump heads (except SAN)
- Isolates stainless steel cylinder case from process fluid for maximum chemical inertness
- 1/4-28 female thread provides minimal system dead volume
- Typically used with FMI **Q661 Small Bore Tubing Kit**
- Ideal for chromatography applications when used with **PD-60-LF Pulse Dampener** (max 65 psi)
- For flows up to 50 mL/min and pressures to 100 psig

**R479**

R479 Kit for LOW FLOW APPLICATIONS (Replaces R412, when used)

**Kit #R479** Consisting of four ferrules, two adapters & assembly/removal tools

**#R478** Consists of ten spare ferrules



**Q485**

## Q485 Dial Indicator Kit

- Ultra-precise flow adjustment for **Q** pumps
- Responds to the slightest adjustment of the **Q** pump adjusting knob
- Each increment on direct reading dial represents 1/1000 of maximum flow
- Easily attaches to all **Q** Pump bases
- Can be ordered with pump or separately

Kit # Q485

## Low Flow Barb Adaptors for 1/16" & 1/8" I.D. Tubing

Threaded 1/4-28 UNF fitting to PVDF barb bottom sealing, rotating adaptors consisting of a white nylon 1/4-28 fitting with 5/16" hex nut and PVDF (fluid path) insert barb.



**#110873A** for use with 1/8" (3.2 mm) I.D. tubing. Pkg. of 10



**#110874A** for use with 1/16" (1.6 mm) I.D. tubing. Pkg. of 10



**#110847-01** for use with 1/8" flexible tubing connection to isolation gland stainless steel "Q" Pumps



# Accessories

## PD-HF In-Line Pulse Suppressor (For High Flow Applications)

- For high flow systems of 50 mL/min or greater and stroke rates higher than 150 rpm against head pressures of 10 to 65 psig
- Unique encapsulated polyethylene bellows design that eliminates tubing vibrations and cavitation problems
- Easy to connect 1/4" compression fittings
- Best results when installed on both suction and discharge lines



**PD-HF**

## Corrugated Teflon® Tubing Pulse Suppressor (For High Flow Applications)

- Highly flexible no-kink tubing for high flow, (50 mL/min or greater), high pressure (100 psig) applications
- Eliminates cavitation and mechanical stress
- Best results when used on both suction and discharge lines
- Slips over 3/8" barbed fitting, 3/8" I.D. x 12" long

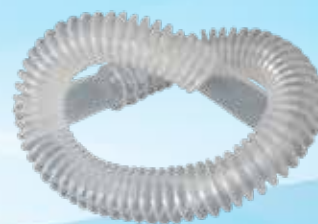

**# 58003**

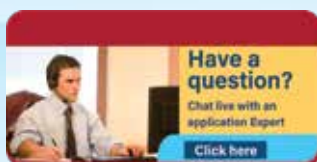

**Have questions?**  
Chat live with an FMI application specialist at [www.FluidMetering.com](http://www.FluidMetering.com)

### Tubing Adaptors



For Plastic Case Pump Heads - The integrally molded port fittings on the standard FMI Type K pump heads accept all 1/4" O.D. tubing. For other tubing arrangements, special port adapters are required.

- #R412-0K Adaptor for 1/8" I.D. tubing
- #R412-1K Adaptor for 1/4" I.D. tubing
- #R412-2K Adaptor for 3/8" I.D. tubing
- #R412-6K Adaptor for 1/2" I.D. tubing
- #R412-5K Adaptor for 1/4-28 ferrule fittings
- #H476-K Adaptor for 1/8" O.D. tubing
- #110949 Adaptor for 6 mm O.D. tubing

Stainless steel adaptors are used with FMI Type S pump heads.

- #R412-1 Adaptor for 1/4" I.D. flexible tubing
- #R412-2 Adaptor for 3/8" I.D. flexible tubing



# H Typical Flow / Dispense Data

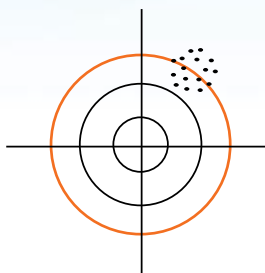
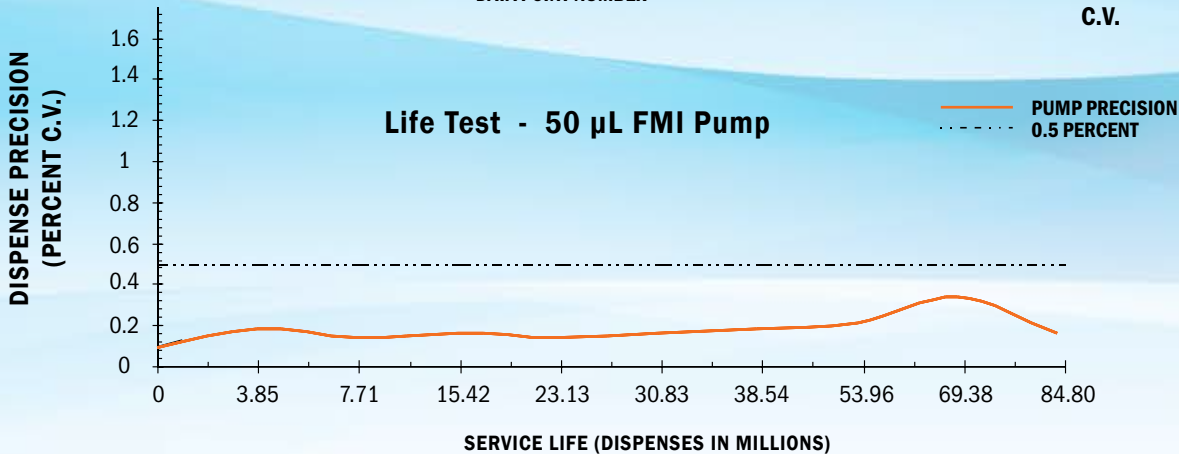
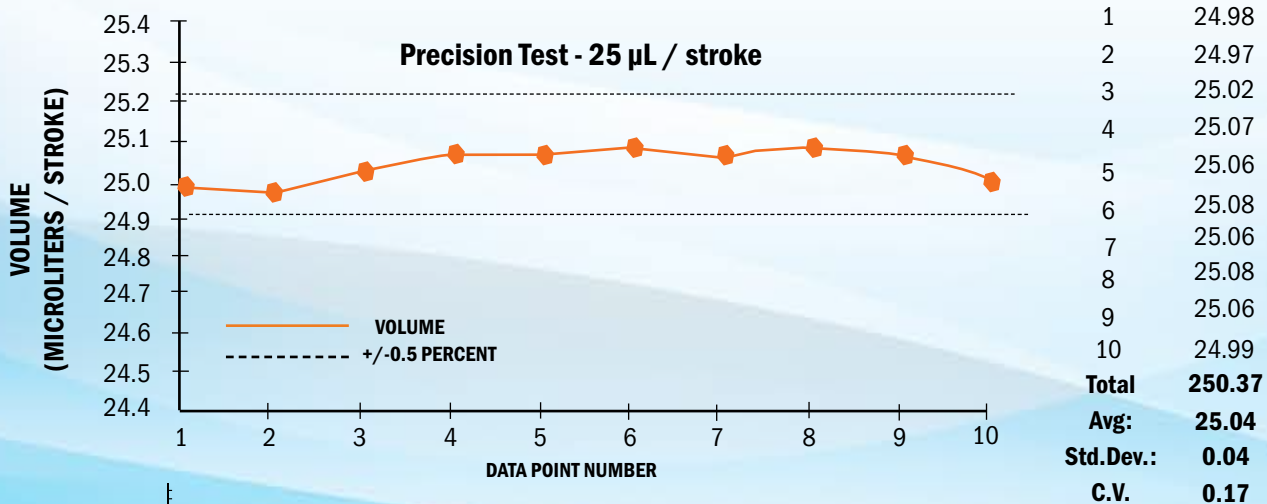
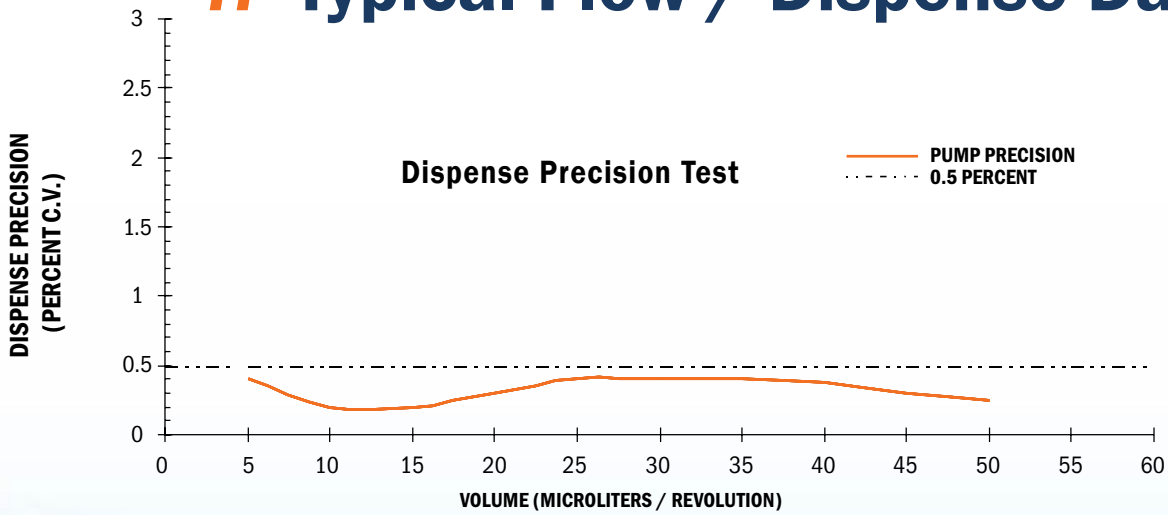

## Precision

Repeatability and degree of variation of a set of values

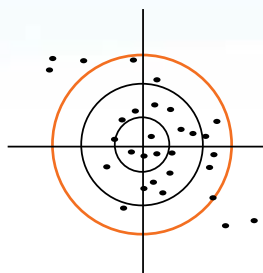

## Accuracy

How close the average value is to the true value

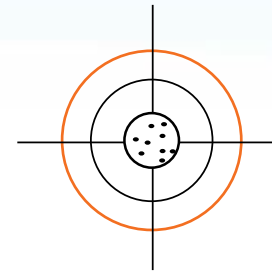

## FMI Pumps

Accurate & Precise





# Q Typical Performance Curves

Performance curves shown below are applicable to the “Q” line of metering pumps.

Performance Curve shown represents a test run on an FMI LAB PUMP handling ambient air at 70°F with CKY Pump Head Module.

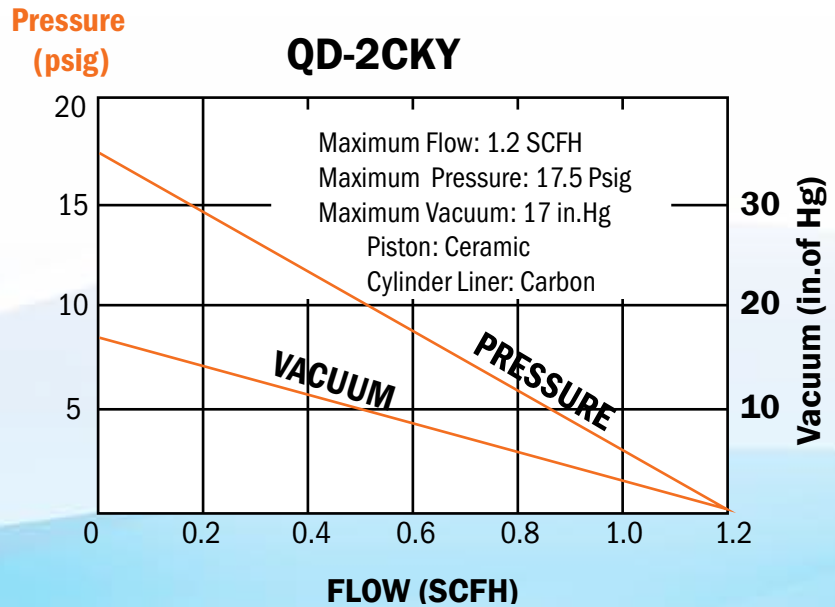

**PERFORMANCE FLOW CURVES:** Typical flow “curves” for FMI LAB PUMPS with **CSC** pump heads handling water at a pump setting of 100% full stroke. Internal fluid slip (decrease in flow with increased pressure) is lowest at 100% stroke and increases as stroke displacement is decreased. Always select a pump with maximum output nearest your actual requirement.

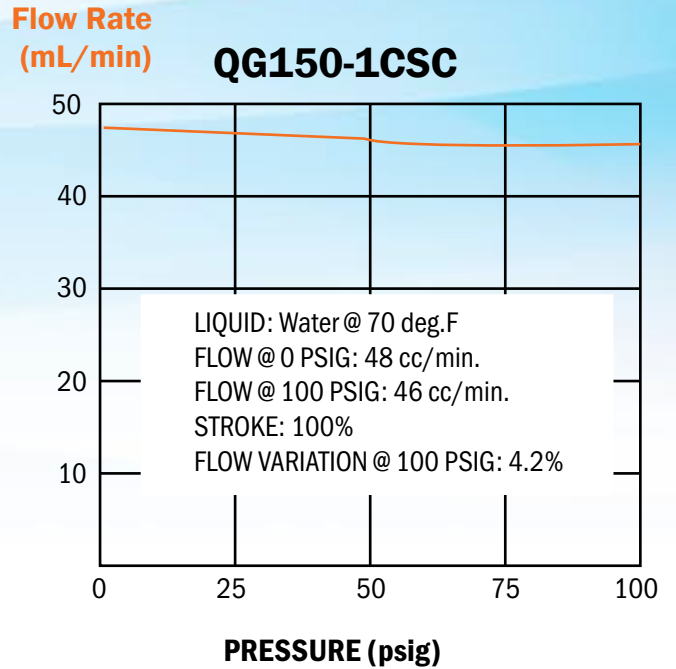
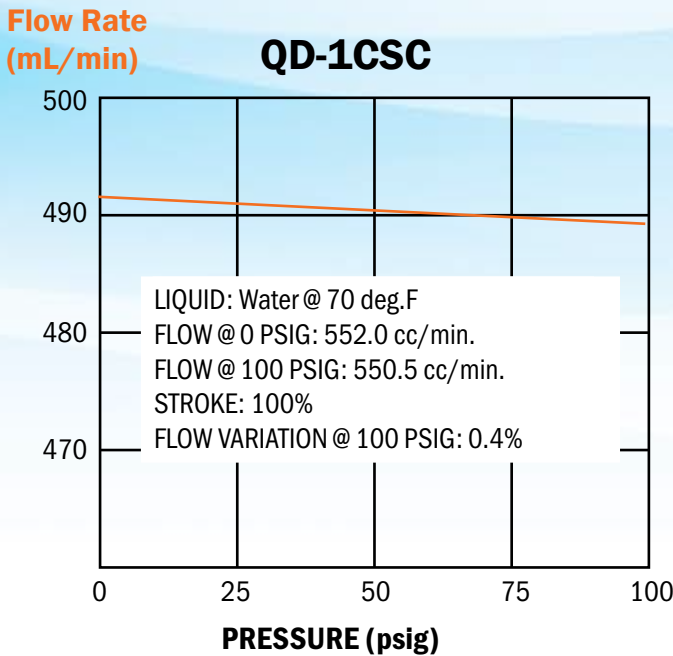

# Materials of Construction

FMI fluid contact components are fabricated of carefully selected materials. Each one has discrete characteristics of physical strength, abrasion resistance, and dimensional stability under varying conditions of pressure, temperature, and resistance to attack by certain chemicals. Since no one material possesses all of the characteristics required to handle all chemicals under all possible conditions, FMI offers a selection of materials of construction for each pump component that fluids contact during the pumping process. These components and materials are identified below by code designation, common usage names and trade names. General characteristics are as follows:

## C — Ceramic\*

Ceramic is used in most of the pumps for piston and/or cylinder liners. Ceramic pistons may be used with ceramic and carbon cylinder liners. Ceramic cylinder liners can only be used with ceramic pistons. Sapphire hard, fused crystalline Ceramic Al<sub>2</sub>O<sub>3</sub>, excellent chemical resistance, thermal stability and mechanically resistant to common abrasives.

**\*Caution:** Subject to binding or freezing when stored after improper cleaning - brittle and subject to fracture under sudden impact loading -not suitable for very "dry" fluids such as hexane.

## Z — Zirconia\*

YTZP pistons for H00 ceramic liners in very low dispense/flow apps .

**\*Caution:** Subject to binding or freezing when stored after improper cleaning - brittle and subject to fracture under sudden impact loading -not suitable for very "dry" fluids such as hexane.

## K — Fluorocarbon PVDF

Fluorocarbon PVDF, is used for some cylinder cases and tubing fittings. Autoclavable @ 240°F maximum. Good chemical tolerance to most fluids.

**Caution:** Sensitive to degrading effects of some organic solvents, esters, and ketones.

## S — Stainless Steel 316

Stainless Steel 316 is used for some pistons, cylinder cases and/or tube fittings. Not to be used as piston with ceramic cylinder liner. Excellent chemical, and physical strength characteristics.

**Caution:** Subject to attack by some halides, strong acids, and bases - subject to surface abrasion and wear in piston application.

## Y — Carbon

Carbon is used for some cylinder liners. Suitable for use with stainless steel and ceramic pistons.

Hard crystalline stage, ingot sintered, pure carbon chemically resistant to most commonly used fluids.

**Caution:** Sensitive to strong oxidants and all abrasive materials.

## T — ETFE

**Fluoropolymer E-TFE** - Used for cylinder cases in some FMI pump head modules. Excellent chemical resistance to most acids, bases and solvents. Autoclavable @ 240°F maximum.

### Rulon® AR, Saint-Gobain

Fluorocarbon, filled PTFE - Used for lip seals in some FMI pump heads. Excellent chemical resistance, - physically soft, resilient and wear resistant - abrasive to soft metals and should therefore not be used with "S" pistons in high stroke rate applications.

### Rulon® J, Saint-Gobain

Fluorocarbon, filled PTFE - Used for lip seals in some FMI pump heads. Good chemical resistance, sensitive to some organic solvents, strong acids and bases - physically soft, resilient and non-abrasive.

### PTFE

Fluorocarbon PTFE - Used for seals and fittings in some FMI pump head modules - excellent chemical resistance characteristics - soft, pliable, easily cut, nonstick surface chemically stable over wide thermal range, dimensionally sensitive to temperature change -not suitable for structural components.

## Application Tips

**PRESSURE:** In most FMI pump models, motor starting torque is the limiting factor in the stated pressure rating. Fluids such as oils, creams and gels that are good lubricants are more easily pumped than aqueous or "dry" fluids and therefore require less motor torque and may be pumped against pressures considerably greater than those given in the rating charts.

All pump head components are designed to withstand backpressures up to 100 psig at room temperatures, though pump heads with fluorocarbon cylinder cases may exhibit some loss of pumping capacity at pressures over 60 psig.

**ACCURACY:** FMI pump accuracy is based on a simplified positive displacement mechanism. The valveless design provides a precision of better than 0.5% when handling medium viscosity fluids (50 to 500 centipoise). Aqueous solutions and light solvents work well but may exhibit some sensitivity (fluid slip) to variations in discharge head pressure. Gums, gels and non-abrasive semi-solids are handled with a high degree of accuracy... a direct result of the valveless design.

Viscous, tacky solutions, semi-solids and heavy slurries which tend to resist (cavitate) suction flow into a pump head can be handled with ease by selecting an FMI pump employing a relatively slow reciprocation rate.

The principal flow rate deviations of an FMI pump are fluid slip and stroke repetition rate. These two factors in turn are related to load factors such as viscosity, differential pressure, and drive motor voltage. When these two factors are controlled, the FMI pump will handle most fluids with reproducibility of better than 0.5%.

**GAS PUMPING:** Due to the valveless design of the FMI pump "CKY" and "CSY" pump heads are able to perform accurate gas transfers. With no valves to introduce random compression errors, gas sample flow in bagging, scrubbing and transit operation can be accurately preset based on actual piston displacement.

**IMPORTANCE OF CLEAN FLUIDS:** While a certain amount of caution must be exercised in the use of abrasive fluids in any metering pump, the "CKC" and "CSC" tend to be more tolerant of suspended solids than other metering pumps. To assure fluid compatibility, consult the Materials of Construction information above.

**FOR BEST PUMPING RESULTS:** Select an FMI pump having a maximum flow rating as near to the desired flow rate as possible.



# How To Order

1. Determine your flow rate in mL/min and your pressure requirements in psig
2. Check that the drive power fits your application, i.e. AC, DC, stepper, etc.
3. Check the Piston Size Code for your flow rate and select a Pump Drive Module plus options
4. Go to page 4 and select a Pump Head Module (PHM) compatible with your fluid and application



**Q PUMP DRIVE MODULE**

**Q OR RH PUMP HEAD MODULE**

**COMPLETE PUMP ASSEMBLY**

Pump Drive: QD  
+Option(s): Q485

Cost: \_\_\_\_\_

Pump Head: Q-1CKC  
Option(s) W

Cost: \_\_\_\_\_

= Total Cost:

Pump Drive: \_\_\_\_\_ \$ \_\_\_\_\_  
+ Option: \_\_\_\_\_ \$ \_\_\_\_\_  
Cost: \_\_\_\_\_ \$ \_\_\_\_\_

Pump Head: \_\_\_\_\_ \$ \_\_\_\_\_  
+ Option: \_\_\_\_\_ \$ \_\_\_\_\_  
Cost: \_\_\_\_\_ \$ \_\_\_\_\_

= Total Cost: \$ \_\_\_\_\_

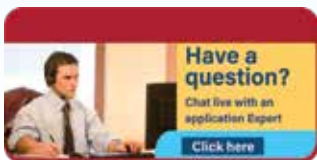

**Have questions?**  
Chat live with an FMI  
application specialist at  
[www.FluidMetering.com](http://www.FluidMetering.com)

## \*GENERAL SPECIFICATION NOTES FOR ALL PUMPS

1. Physical characteristics of your pumped fluid may affect the rating/capacity relationships shown in the performance tables for each FMI pump
2. The maximum flow rates shown in the tables are for H<sub>2</sub>O at 2 psig
3. Flow rates are infinitely variable from zero to maximum capacities shown
4. Pumping capacities are reduced approximately 18% when the Pump Drive Module is operating on a 50 Hz electrical supply
5. Fluorocarbon cylinder cases (Q line only) are rated for a maximum pressure of 60 psig or the lower pressure shown in the charts
6. 3/8" I.D. tubing or greater is required for flows higher than 500 mL/min
7. 1/2" I.D. tubing or greater is required for flows higher than 1200 mL/min



# FMI Terms & Conditions

## FMI LIMITED WARRANTY

FMI products are manufactured to a high level of mechanical precision from materials that are resistant to attack by many corrosive chemicals. These products, however, may be self-destructive when used with non-compatible fluids or when located in physically hostile environments or when operated under non-specification voltage or pressure conditions.

FMI, therefore, warrants only as follows:

Each pump has been test operated with water prior to shipment from the factory. The qualifying performance of each pump is recorded by serial number in a permanent record of the company. The Goods shall be free of liens, are new and unused, and perform in accordance with the published or agreed written specifications and be free from defects in materials and workmanship for a period of one year from FMI's invoice date. Goods not meeting specifications may be returned to FMI, freight prepaid, for repair or replacement at FMI's discretion. Prior to any such return, Customer must request and receive written approval from FMI. If, upon examination, FMI determines that abusive practices, non-compatible fluids or destructive environment of operation or a combination of these factors is responsible for improper performance of the product, all labor and materials costs involved shall be at the expense of the customer. All such returns shall be redelivered Ex Works, Syosset, NY. Warranty returns may not be used to offset amounts owing for past or future deliveries.

FMI is not liable for special, indirect or consequential damages that may result from use, failure or malfunction of the product and any recovery against FMI may not be greater than the purchase price paid for the product.  
No person or entity is authorized to change the terms of this warranty

### PRODUCT STANDARDS

FMI products are certified and sold to comply with written FMI specifications. Only FMI is authorized to modify product claims and specifications. Products are subject to change without notice.

### RETURNS FOR CREDIT

Standard FMI catalog products under most circumstances, may be returned to the FMI factory for credit when still in unused condition, packed in original shipping cartons, and meets current product specifications. All such returns, must have prior FMI customer service authorization before returning. A restocking charge of 15% of original invoice price will be made on each to cover related restocking costs.

### PRICES

Prices are subject to change without notice and prior to order confirmation.

### QUANTITY DISCOUNTS

Quantity discounts on standard catalog products purchased in units of ten or more are available. Contact FMI sales department for details.

### QUOTATIONS

Prices quoted in writing will remain in effect for 30 days or any other time period stated in the written quotation.

### MINIMUM BILLING

Minimum billing for FMI products is \$75.00 domestic and foreign invoice value per order, net of shipping costs and any applicable discounts regardless of price list value of order.

### ORDERS

Orders placed for Goods cannot be cancelled and will be shipped and invoiced by FMI per the confirmed delivery schedule. FMI is not responsible for delays beyond its control, including but not limited to, component shortages, delays by its vendors, labor disputes, weather delays or military actions.

All goods are delivered Ex Works, Syosset, NY at which time title and risk of loss shall pass to the Customer.

### FREIGHT POLICY

FMI will assist Customer with arranging transportation via pick-up, prepay and bill, or freight collect. Goods will be packed for domestic shipment unless other packaging arrangements have been mutually agreed upon in writing. All shipping costs and any special packaging are the responsibility of the Customer. Insurance is the responsibility of the Customer. All claims for damaged merchandise should be made with Customer's delivering carrier or insurance company.

### PAYMENT TERMS

Open Account terms - 1% 10 days, net 30, International Sales - cash in advance. Credit Card Payments are accepted, Visa, Master Card, AMEX and Discover. Quoted prices are subject to change for payment terms other than those listed above. All bank charges related to wire transfers and ACH payments are the customer's responsibility.

### OPEN ACCOUNT PRIVILEGES

Customers may establish an open account status by presenting FMI evidence of prompt payment history including: a) three general credit references, b) one or more bank references, c) Fluid Metering, Inc. reserves the right to obtain a credit report from a national reporting agency.

FMI Customer Service Representatives and Technical Support Staff are available Monday through Friday from 8:00 a.m. to 5:00 p.m. EST. You can also FAX your specifications 24 hours a day to 516-624-8261 or Email us at: pumps@fmipump.com



# Celebrating 59 Years Dedicated to Quality and Service

## Who We Are

FMI pioneered the first patented valveless rotating and reciprocating piston metering pump concept and has been delivering pumping excellence and precise fluid control for over 50 years.

## Engineering Design & Development

Our Engineering Team incorporates over 50 years of design experience to meet specific customer & application requirements. With the knowledge and the necessary tools, our engineers have developed the most precise and reliable valveless dispensing and metering pumps available.

## Our Large Inventory

FMI continues to maintain an extensive inventory for fast shipment of your orders - most catalog items are shipped via UPS within 24 hours of receipt of order. Need it faster? We can get it to you overnight with UPS Next Day, Express Mail, or Federal Express Priority 1 service. Just let us know when placing your order.



## Why FMI?

### Ultra-Precise Fluid Control. . . from Microliters to Liters

- **Patented “No-Valve” Design**  
Eliminates problems and errors caused by valves which clog, leak, hang up, and require service.
- **One Moving Part!**  
**CeramPump®** design utilizes a single, dimensionally stable, chemically inert CERAMIC piston and cylinder ensuring long term, drift free fluid control.
- **Proven Performance!**  
Over 50 years OEM application experience and more than 250,000 OEM pumps in service.
- **Accuracy, Precision, & Reliability**  
Better than  $\pm 1\%$  Measured in millions of “trouble-free” cycles.

## Quality

**We take quality seriously and back it up, not only as an ISO 9001:2015 facility, but far beyond! Most products are WEEE & RoHS Compliant.**

**Our Mission Statement . . .  
100% Quality, 100% On-Time Delivery**

**. . . is supported by our valued  
OEM supplier awards.**



## Easy Ordering and Technical Support

It's not always easy to determine which pump is best for your application. At FMI our trained Technical Support staff is available to assist you in making the right choices for all your pumping applications.

Call us Toll-free at **800-223-3388** or call **1 516-922-6050**.  
Visit our web site at [www.FluidMetering.com](http://www.FluidMetering.com).

## eSupport (FMI web site)

Need product and technical information immediately? Check our web site at [www.FluidMetering.com](http://www.FluidMetering.com) and have instant access to product specifications, application information, literature downloads, and an animation of our unique **CeramPump®** valveless pumping principle.

Also featured in our web site is LiveHelp, which provides a one on one connection between our customers and FMI's application specialists.

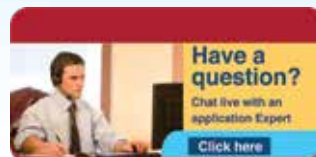

Have questions?  
Chat live with an FMI  
application specialist at  
[www.FluidMetering.com](http://www.FluidMetering.com)



# Typical Applications

## Analytical Instrumentation

- TOC Analyzer
- Particle Analyzers
- Viscosity Instrumentation
- Titration Equipment
- Liquid Chromatography
- Water & Wastewater Monitoring
- Stack Gas Monitoring
- Ground Water Monitoring

## Medical

- Contact Lens Mfg. - Monomer Dispensing
- Dialysis Systems
- Immunoassays & MicroPlates
- Solvent Welding for Disposables
- Blood Analyzer Sample & Reagent Fluid Control
- Clinical Chemistry Instrumentation

## Electronics

- Plating Bath Chemical Control
- PC Board Cleaning Systems
- Battery Manufacturing
- CMP & ECP Wafer Processing
- Flux Addition for Wave Soldering
- Wire Coating for Stators & Armatures
- Semiconductor Chemical Distribution

## Food, Dairy, & Beverage

- Aseptic Packaging - Peroxide Dispensing
- Preservative Treatment of Meats & Poultry
- Nutrient & Color Addition
- Brewery Additives
- Vitamin Addition for Milk
- Color Addition for Yogurt
- Cottage Cheese Mfg.
- Candy Polishing

## Industrial

- Agricultural & Pesticide Spraying Systems
- On-Site Petroleum Additives
- Paints, Dyes, Inks, & Pigments
- Lubricant Dispensing
- Ferrofluid Dispensing for Speaker Mfg.
- Hydrogen Fuel Cell Fluid Control



## FMI 2019 SHOW SCHEDULE

SLAS 2019	Feb. 2 - 6	Walter E. Washington Convention Center	Washington, DC	Booth # TBA
MD&M West	Feb. 5 - 8	Anaheim Convention Center	Anaheim, CA	Booth # 2383
Medtec Japan	March 18 - 20	Tokyo Big Sight	Tokyo, Japan	Booth # TBA
PITTCON 2019	March 19 - 21	Pennsylvania Convention Center	Philadelphia, PA	Booth # TBA
CMEF-IVD	May 14 - 17	National Exhibition and Convention Center	Shanghai, China	Booth # TBA
AACC Expo 2019	Aug 4 - 8	Anaheim Convention Center	Anaheim, CA	Booth # TBA
MEDIX Tokyo	Oct. 23 - 25	Tokyo Big Sight	Tokyo, Japan	Booth # TBA
MD&M Minneapolis	Oct. 31 - Nov.1	Minneapolis Convention Center	Minneapolis, MN	Booth # TBA
MEDICA 2019	Nov. 18 - 21	Messe Dusseldorf	Dusseldorf, Germany	Booth # TBA



Fluid Metering, Inc.  
 5 Aerial Way, Suite 500,  
 Syosset, NY 11791 USA  
 Tel: 1-516-922-6050  
 Toll-free: 1-800-223-3388  
 Fax: 1-516-624-8261  
 Email: pumps@fmipump.com  
 Website: www.FluidMetering.com