



# Operating Manual



**PC-Series**



**P-Series**



**PC3-Series**



**PCD-Series**



**PCR-Series**

## Digital Pressure and Vacuum Gauges and Controllers

*The Fastest Flow Controller Company in the World!*



## RECALIBRATION

Your Alicat instrument is a precision device and Alicat strongly recommends that you send it to us on a yearly basis for recalibration.

A yearly recalibration does a few things:

- ▶ It insures that your unit is functioning according to specification.
- ▶ Contamination may cause the instrument to measure flow improperly. Recalibration insures the instrument is clean and free from debris.
- ▶ Recalibration maintains your LIFETIME WARRANTY!

Sending your unit for recalibration is easy and inexpensive. Recalibrations are usually shipped within five days of receipt, so it's fast too.

Please keep the original box to return your Alicat instrument for recalibration.

For more information regarding recalibration see page 46.

## ACCESSORIES

Now that you have your Alicat instrument are you sure you've got everything you need? Alicat accessories can make your job easier.

Many of our customers also order:

- ▶ Power Supplies — A universal wall power supply that makes it easy to power your Alicat unit just about anywhere in the world.
- ▶ BB9 — Alicat's multi-drop box that allows easy connection of up to nine Alicat instruments to a single USB, RS-232 or RS-485 port.
- ▶ MD8DB9 — An RS-232 to 8 pin Mini-DIN cable to connect your Alicat instrument to a computer. A variety of other cables are also available.
- ▶ Flow Vision™ SC — A GUI based Windows® program that allows easy computer access and control for one or multiple Alicat instruments.
- ▶ Fittings and filters — Keep your instrument properly connected to your process and free from harmful contamination.

See pages 50-53 for a complete description and list of Alicat accessories.

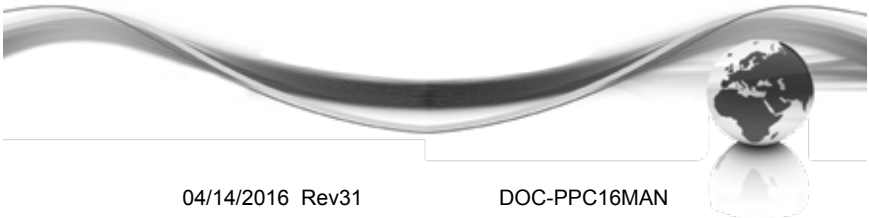

Thank you for purchasing a P-Series Pressure Gauge or PC-Series Vacuum and Pressure Controller. Please take the time to find and read the information for your specific device. This manual covers the following Alicat Scientific instruments:

**P-Series Digital Pressure Gauge**

**PC-Series Vacuum and Pressure Controllers**

**PCR-Series High Flow Vacuum and Pressure Controllers**

**PCD and PCRD-Series Dual Valve Pressure Controllers**

**PS, PCS, PCRS, PCDS and PCRDS-Series** — instruments for use with aggressive gases (see page 64).

**PC3, PCD3, PCR3 and PCRD3-Series Vacuum and Pressure Controllers** — pressure controllers fitted with an external pressure port for sensing and controlling pressures at a remote point in the system (see page 32).

**PC-EXTSEN Pressure Controllers** — instruments for use with an end-user supplied external sensor (see pages 88-90).

This includes P, PC and PCR-Series devices labeled as approved for CSA Class 1 Div 2 and ATEX Class 1 Zone 2 hazardous environments. See pages 91 and 92 for Special Conditions regarding the use of CSA/ATEX labeled devices.

The installation (plumbing, mounting and power/signal connection instructions are applicable to all P, PC (includes PC3), PCR (includes PCR3) and PCD-Series devices.

**Unless specifically noted, all instructions for PC-Series Controllers are applicable to PC3, PCR, PCR3, PCD, PCD3, PCRD and PCRD3 controllers as well.**

**Alicat Portable Pressure Gauges**

**Note:** Alicat Portable Pressure Gauges operate in accordance with the P-Series Pressure Gauge instructions found in this manual. Please see page 46 for information regarding use and recharge.



***Please contact Alicat at 1-888-290-6060 or info@alicat.com if you have any questions regarding the use or operation of this device.***

***Many Alicat instruments are built for specific applications. Two instruments with the same flow range and part number may look and act quite differently depending upon the application the instrument was built for. Care should be taken when moving an instrument from one application to another.***



You can find a number of instructional videos related to the operation of this device by visiting the Alicat web site or scanning the QR code.



<http://www.alicat.com/support/instructional-videos/>

<b>TABLE OF CONTENTS</b>	<b>Page</b>
GETTING STARTED	6
MOUNTING	7
PLUMBING	7
USING ALICAT PRESSURE INSTRUMENTS WITH FLUIDS	8
SPECIAL CONFIGURATIONS	8
External Sense Port	8
Differential Pressure	8
POWER AND SIGNAL CONNECTIONS	9
INPUT SIGNALS	10
Analog Input Signal	10
RS-232 / RS-485 Digital Input Signal	11
OUTPUT SIGNALS	12
RS-232 / RS-485 Digital Output Signal	12
Standard Voltage (0-5 Vdc) Output Signal	12
Optional 0-10 Vdc Output Signal	12
Optional Current (4-20 mA) Output Signal	12
Optional 2nd Analog Output Signal	12
Information for Alicat TFT (Color Display) Instruments	14
DISPLAYS AND MENUS P-SERIES GAUGES	15
MAIN	16
Line Pressure	16
Tare	16
<i>Flashing Error Message</i>	16
SELECT MENU	17
COMMUNICATION SELECT	18
Unit ID	18
Baud	18
MISCELLANEOUS	19
MISC1	19
Zero Band	19
Pressure Averaging	19
Flow Averaging	19
LCD Contrast	19
MISC2	20
Rotate Display	20
DIAG TEST	20
DEVICE UNITS	21
MANUFACTURER DATA	22
DISPLAYS AND MENUS PC AND PCR-SERIES CONTROLLERS	23
MAIN	24
SELECT MENU	25
CONTROL SET UP	26
Set-Point Source	26
Loop Variable	27
On / Off Auto-tare	28

<b>TABLE OF CONTENTS</b>	<b>Page</b>
PID Tuning	29
PRESSURE CONTROL APPLICATION: UPSTREAM VALVE	31
BACK PRESSURE CONTROL APPLICATION: DOWNSTREAM VALVE	31
PC3-Series PRESSURE CONTROLLERS	32
DIFFERENTIAL PRESSURE GAUGES	33
DIFFERENTIAL PRESSURE CONTROLLERS	34
PCD and PCRD DUAL VALVE CONTROLLER OPERATION	35
RS-232 OR RS-485 OUTPUT AND INPUT	36
Configuring HyperTerminal®	36
Streaming Mode	36
Tareing via RS-232 / RS-485	37
Sending a Set-point via RS-232 / RS-485	37
PID Tuning via RS-232 / RS-485	38
Changing from Streaming to Polling Mode	39
Collecting Data	40
Data Format	41
Sending a Simple Script File to HyperTerminal®	42
Supported Units List	44
TROUBLESHOOTING	45
MAINTENANCE AND RECALIBRATION	46
Option: Portable Meters and Gauges	47
Pressure Menu for Portable Meters	48
Option: Remote Electronics	49
Option: Remote Panel Display	49
Accessory: BB9 Multi-Drop Box	50
Accessory: Flow Vision™ SC	51
Accessory: Flow Vision™ MX	51
Accessories	52
P Gauge Technical Specifications	54
PC, PC3 PCR and PCR3 Controller Technical Specifications	56
PCD, PCD3, PCRD and PCRD3 Controller Technical Specifications	60
Technical Data for Aggressive Gas Pressure and Vacuum Devices	64
PS Gauge Technical Specifications	65
PCS and PCRS Technical Specifications	67
PCDS and PCRDS Technical Specifications	69
PROFIBUS Technical Specifications	72
<b>Eight Pin Mini-DIN Pin-Out</b>	<b>73</b>
<b>Locking Industrial Connector Pin-Out</b>	<b>74</b>
<b>DB9 Pin-Out Diagrams</b>	<b>75</b>
<b>DB15 Pin-Out Diagrams</b>	<b>81</b>
<b>NOTES FOR USING PC-EXTSEN CONTROLLERS</b>	<b>88</b>
<b>Information for CSA and ATEX Labeled Devices</b>	<b>91</b>

# GETTING STARTED

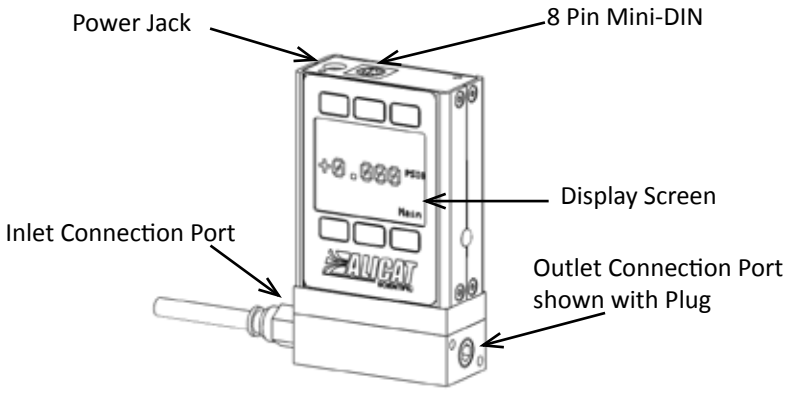

**P-Series Pressure Gauge**

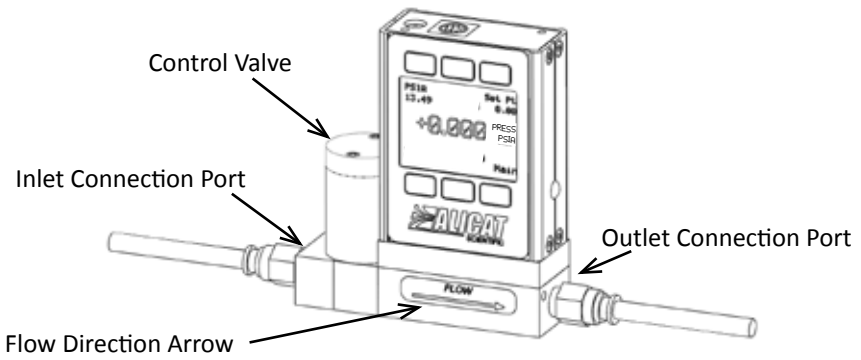

**PC-Series Pressure Controller** Shown with Standard Upstream Valve

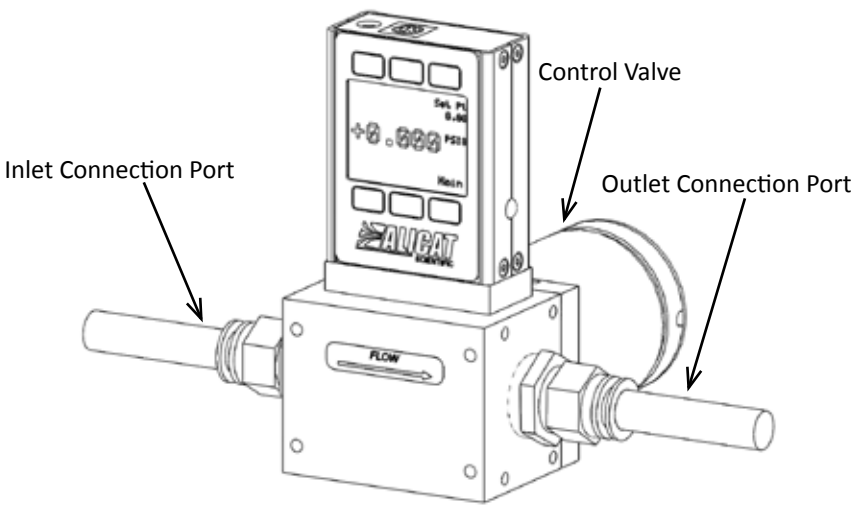

**PCR-Series Pressure Controller**

## MOUNTING

All P-Series Gauges and PC-Series Controllers have mounting holes for convenient mounting to flat panels. These gauges are position insensitive and can be mounted in any orientation. The sizes and dimensions for the mounting holes are shown on pages 54 to 70.

P-Series Pressure Gauges may be connected into your system with the flow going in either direction for ease of viewing the display. These units are shipped with a plug for dead end applications. This plug should be removed for flow through applications.

PC-Series Vacuum and Pressure Controllers are normally intended to control the process pressure *downstream* of the controller. In order for this to occur the controller should be mounted so the flow goes from left to right as you look at the front of the unit. This puts the measuring portion of the device between the valve and the leakage point where you are attempting to control the pressure application. Back-pressure controllers reverse this configuration (see page 31).

## PLUMBING



***Your instrument is shipped with plastic plugs fitted in the port openings. To lessen the chance of contaminating the flow stream do not remove these plugs until you are ready to install the device.***

***Make sure that flow is in the direction indicated by the flow arrow.***

Standard P-Series Gauges and PC-Series Controllers have female inlet and outlet port connections. Welded VCR and other specialty fittings may have male ports.

The inlet and outlet port sizes (process connections) for different flow ranges are shown on pages 54-70.

Instruments with M5 (10-32) ports have O-ring face seals and require no sealant or tape. Do not use tape with welded or O-ring fittings.

For non M5 (10-32) ports use thread sealing Teflon® tape to prevent leakage around the port threads.

***Do not wrap*** the first two threads. This will minimize the possibility of getting tape into the flow stream and flow body.



***Do not use pipe dopes or sealants on the process connections as these compounds can cause permanent damage to the controller should they get into the flow stream.***

When changing fittings, carefully clean any tape or debris from the port threads.



***Connecting Fittings and Filters***

***<http://www.alicat.com/support/instructional-videos/>***

***For additional notes on PCD (dual valve controller) plumbing see page 35.***

***For gas applications,*** it is recommended that a 40 micron filter be installed upstream of P and PCR-Series instruments and a 20 micron filter be installed upstream of PC and PCD-Series instruments.

***For liquid applications,*** see “Using Alicat Pressure Instruments with Fluids”, page 8.

## USING ALICAT PRESSURE INSTRUMENTS WITH FLUIDS

All of these devices may be used with chemically compatible liquids providing a couple of things are taken into account:

1. Water is about 50 times more viscous than air. This is important when sizing a pressure controller. The PC-Series which can be used to flow up to 20 SLPM of gas, will be limited to roughly 0.5 LPM of water-like fluid. The PCR will be limited to roughly 30 LPM of water-like fluid.
2. The factory PID tune is established using air flow. It may be necessary to adjust the PID tuning parameters if you will be using a controller with liquids.

## SPECIAL CONFIGURATIONS

P, PC, and PCR-Series pressure devices are occasionally ordered with special configurations which are covered here:

1. External Sense Port: Occasionally it is necessary or desirable to sense the pressure at some point other than at the location of the pressure device. All P, PC, or PCR-Series pressure devices can be ordered with an additional NPT port which is connected directly with the pressure sensor of the device. In these devices the flow path through the device is NOT connected to the pressure sensor. See “PC3-Series Pressure Controllers” – page 32.
2. Differential Pressure: Occasionally it is necessary or desirable to monitor or control a differential pressure. P, PC, and PCR-Series pressure devices can be ordered as low differential pressure devices (usually 1 to 5 psid). These devices have two ports located on the front face of the unit for connection to the points in the system where the differential pressure is to be measured. The upstream port is for the higher pressure and the downstream port is for the lower pressure. In these devices the flow path through the device is NOT connected to either leg of the differential pressure sensor. See “Differential Pressure Gauges and Differential Pressure Controllers” – pages 33 & 34.

**PC-EXTSEN** units connect a Pressure Controller (with no internal pressure sensor) to an end-user supplied external pressure sensor. Designed mainly for the vacuum coating industry, the PC-EXTSEN marries the sensing ability of an existing capacitance manometer or ion gauge with a 16-Series electronics package and internal PID algorithm. This enables fast and precise control of extreme vacuum conditions in the coating chamber. See pages 88-90.



**CAUTION! EXCEEDING THE MAXIMUM SPECIFIED LINE PRESSURE MAY CAUSE PERMANENT DAMAGE TO THE SOLID-STATE DIFFERENTIAL PRESSURE TRANSDUCER.**



## POWER AND SIGNAL CONNECTIONS

Power can be supplied to your gauge/controller through either the power jack (power jack not available on CSA/ATEX approved devices) or the 8 pin Mini-DIN connector.

An AC to DC adapter which converts line AC power to DC voltage and current as specified below is required to use the power jack.

A 2.1mm, positive center, 7-30 Vdc AC/DC adapter rated for at least 100 mA is required to use the adapter jack in a **P-Series meter**.

A 2.1mm, positive center, 12-30 Vdc AC/DC adapter rated for at least 250 mA is required to use the adapter jack in a **PC-Series controller**.

A 2.1mm, positive center, 24-30 Vdc AC/DC adapter rated for at least 500 mA is required to use the adapter jack in a **PCR-Series controller**.

**NOTE:** 4-20mA analog output requires at least 15 Vdc.

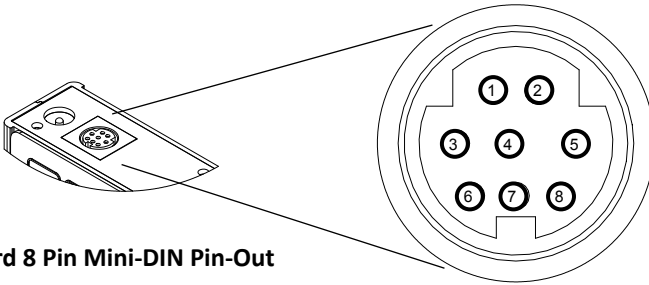

**Standard 8 Pin Mini-DIN Pin-Out**

Pin	Function	Mini-DIN cable color
1	Not Connected (or optional 4-20mA Primary Output Signal)	Black
2	Static 5.12 Vdc [or optional Secondary Analog Output (4-20mA, 5Vdc, 10Vdc) or Basic Alarm]	Brown
3	Serial RS-232RX / RS-485(-) Input Signal (receive)	Red
4	Meters/Gauges = Remote Tare (Ground to Tare) Controllers = Analog Set-Point Input	Orange
5	Serial RS-232TX / RS-485(+) Output Signal (send)	Yellow
6	0-5 Vdc (or optional 0-10 Vdc) Output Signal	Green
7	Power In (as described above)	Blue
8	Ground (common for power, communications and analog signals)	Purple

**Note:** The above pin-out is applicable to all the flow meters and controllers with the Mini-DIN connector. The availability of different output signals depends on the options ordered. Optional configurations are noted on the unit's calibration sheet.

**CAUTION! DO NOT CONNECT POWER TO PINS 1 THROUGH 6 AS PERMANENT DAMAGE CAN OCCUR!**



**It is common to mistake Pin 2 (labeled 5.12 Vdc Output) as the standard 0-5 Vdc analog output signal.** In fact Pin 2 is normally a constant 5.12 Vdc that reflects the system bus voltage and can be used as a source for the set-point signal.

**For 6 Pin Locking Connector, DB9 and DB15 Pin-outs see pages 74 to 87.**

**For PROFIBUS Pin-outs see page 72.**



**Electrical Connections and Basic Wiring**

<http://www.alicat.com/support/instructional-videos/>

## INPUT SIGNALS

### Analog Input Signal

Apply analog input to Pin 4 as shown on page 9.

**For 6 Pin Locking Connector, DB9 and DB15 Pin-outs see pages 74 to 87.**

**For PROFIBUS Pin-outs see page 72.**

**Standard 0-5 Vdc** is the standard analog input signal. Apply the 0-5 Vdc input signal to pin 4, with common ground on pin 8.

**Optional 0-10 Vdc:** If specified at time of order, a 0-10 Vdc input signal can be applied to pin 4, with common ground on pin 8.

**Optional 4-20 mA:** If specified at time of order, a 4-20 mA input signal can be applied to pin 4, with common ground on pin 8.

**NOTE:** This is a current sinking device. The receiving circuit is essentially a 250 ohm resistor to ground.

**NOTE:** 4-20mA output requires at least 15 Vdc power input.



**CAUTION! Do NOT CONNECT THIS DEVICE TO "LOOP POWERED" SYSTEMS, AS THIS WILL DESTROY PORTIONS OF THE CIRCUITRY AND VOID THE WARRANTY. IF YOU MUST INTERFACE WITH EXISTING LOOP POWERED SYSTEMS, ALWAYS USE A SIGNAL ISOLATOR AND A SEPARATE POWER SUPPLY.**

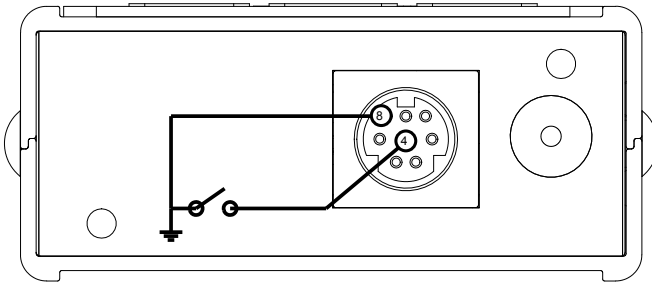

**Gauges:** A remote tare can be achieved by momentarily grounding pin 4 to tare.

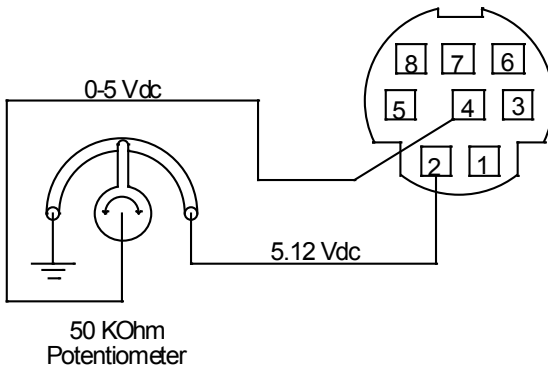

**Controllers:** A simple method for providing set-point to controllers

## RS-232 / RS-485 Digital Input Signal

To use the RS-232 or RS-485 input signal, connect the RS-232 / RS-485 Output Signal (Pin 5), the RS-232 / RS-485 Input Signal (Pin 3), and Ground (Pin 8) to your computer serial port as shown below. (See page 36 for details on accessing RS-232 / RS-485 input.)

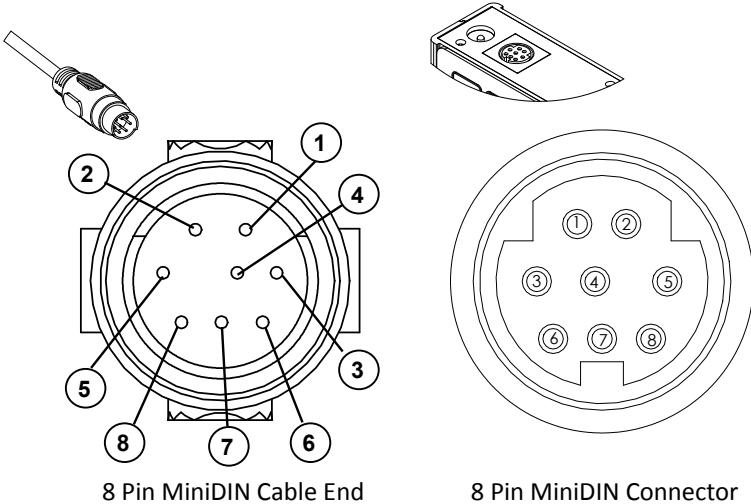
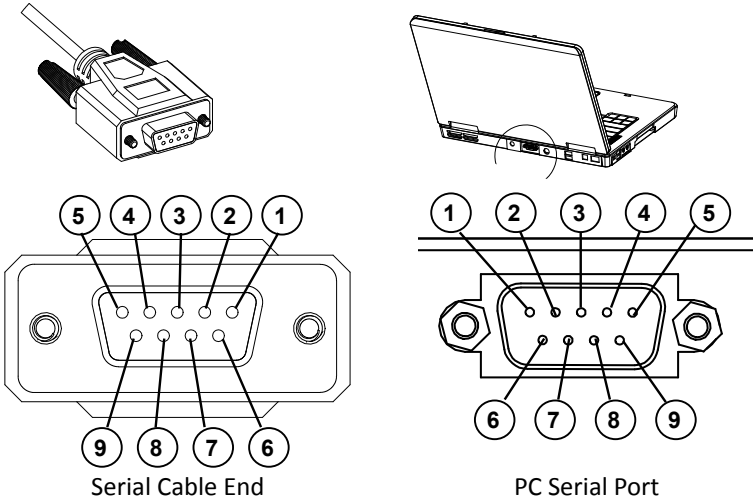

9 Pin Serial Connection		8 Pin MiniDIN Connection	
Pin	Function	Function	Pin
5	Ground	Ground	8
3	Transmit	Receive	3
2	Receive	Transmit	5

DB9 to Mini-DIN Connection for RS-232 / RS-485 Signals

## OUTPUT SIGNALS

### RS-232 / RS-485 Digital Output Signal

To use the RS-232 or RS-485 output signal, it is necessary to connect the RS-232 / RS-485 Output Signal (Pin 5), the RS-232 / RS-485 Input Signal (Pin 3), and Ground (Pin 8) to your computer serial port as shown on page 8. (See page 36 for details on accessing RS-232 / RS-485 output.)

### Standard Voltage (0-5 Vdc) Output Signal

Gauges/controllers equipped with a 0-5 Vdc (optional 0-10 Vdc) will have this output signal available on Pin 6. This output is generally available in addition to other optionally ordered outputs. This voltage is usually in the range of 0.010 Vdc for zero flow and 5.0 Vdc for full-scale flow. The output voltage is linear over the entire range. Ground for this signal is common on Pin 8.

### Optional 0-10 Vdc Output Signal

If your gauge/controller was ordered with a 0-10 Vdc output signal, it will be available on Pin 6. (See the Calibration Data Sheet that shipped with your device to determine which output signals were ordered.) This voltage is usually in the range of 0.010 Vdc for zero flow and 10.0 Vdc for full-scale flow. The output voltage is linear over the entire range. Ground for this signal is common on Pin 8.

### Optional Current (4-20 mA) Output Signal

If your gauge/controller was ordered with a 4-20 mA current output signal, it will be available on Pin 1. (See the Calibration Data Sheet that shipped with your device to determine which output signals were ordered.) The current signal is 4 mA at 0 flow and 20 mA at the device's full scale flow. The output current is linear over the entire range. Ground for this signal is common on Pin 8. (Current output units require 15-30Vdc power.)

### Optional 2nd Analog Output Signal

You may specify an optional 2nd analog output on Pin 2 at time of order. (See the Calibration Data Sheet that shipped with your device to determine which output signals were ordered.) This output may be a 0-5 Vdc, 0-10 Vdc, or 4-20 mA analog signal that can represent any measured parameter. With this optional output, a meter could output the volume flow rate (0-5 Vdc on pin 6) and the line temperature (0-5 Vdc on pin 2).



If your device is CSA/ATEX approved or equipped with the optional six pin industrial connector, please contact Alicat.



**CAUTION! DO NOT CONNECT THIS DEVICE TO "LOOP POWERED" SYSTEMS, AS THIS WILL DESTROY PORTIONS OF THE CIRCUITRY AND VOID THE WARRANTY. IF YOU MUST INTERFACE WITH EXISTING LOOP POWERED SYSTEMS, ALWAYS USE A SIGNAL ISOLATOR AND A SEPARATE POWER SUPPLY.**



**CAUTION! DO NOT CONNECT THIS DEVICE TO "LOOP POWERED" SYSTEMS, AS THIS WILL DESTROY PORTIONS OF THE CIRCUITRY AND VOID THE WARRANTY. IF YOU MUST INTERFACE WITH EXISTING LOOP POWERED SYSTEMS, ALWAYS USE A SIGNAL ISOLATOR AND A SEPARATE POWER SUPPLY.**

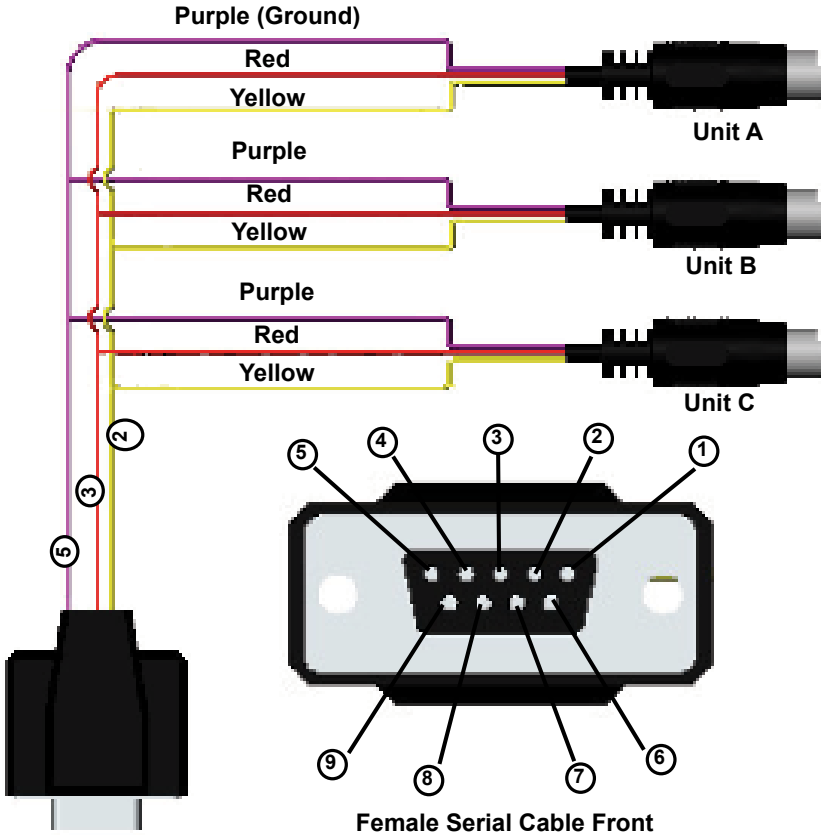

Typical Multiple Device (Addressable) Wiring Configuration



**The easiest way to connect multiple devices is with a Multi-Drop Box (see page 50).**

## Information for Alicat TFT (Color Display) Instruments

Alicat TFT (color display) instruments have a high contrast back-lit LCD display. TFT instruments operate in accordance with Alicat standard operating instructions for our monochrome menus and displays with the following differences.

### Multi-Color Display Color Codes:

**GREEN:** Green labels identify the parameters and/or adjustments associated with the button directly above or below the label.

**WHITE:** The color of each parameter is displayed in white while operating under normal conditions.

**RED:** The color of a parameter is displayed in red when operating conditions for that parameter exceed 128% of the device's specifications.

**YELLOW:** Yellow is the equivalent of the selection arrow on the monochrome display.

### LCD Contrast:

LCD contrast is ranged from 0 to 11 on color displays with 11 being the greatest contrast.

### Display On/Off:

Pushing the button under the Alicat name will turn the device display on or off. This feature is not available on monochrome displays.

### Technical Data for TFT (Color Display) Meters, Gauges and Controllers

The following specifications are applicable to Alicat **TFT** (color display) meters, gauges and controllers only. All other operating specifications are shown in the Technical Data page for standard Alicat instruments. All standard device features and functions are available and operate in accordance with the Alicat operating manual provided with the device.

Specification	Meter or Gauge	Small Valve Controller	Large Valve Controller
Supply Voltage	7 to 30 Vdc	12 to 30 Vdc	24 to 30 Vdc
Supply Current	80 mA @ 12Vdc 70 mA @ 24Vdc	290 mA @ 12Vdc 200 mA @ 24Vdc	780 mA @ 24Vdc

# DISPLAYS AND MENUS P-Series GAUGES

(Displays and Menus for PC and PCR Controllers are shown beginning page 23.)

The device screen defaults to **Main** display as soon as power is applied to the meter.

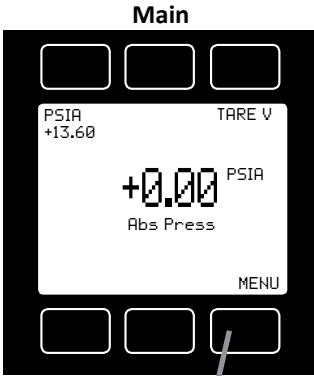

The **Main** display shows the pressure in the units specified at time of order. By hitting the **MENU** button at the bottom right of the screen you will enter the **Select Menu** display.

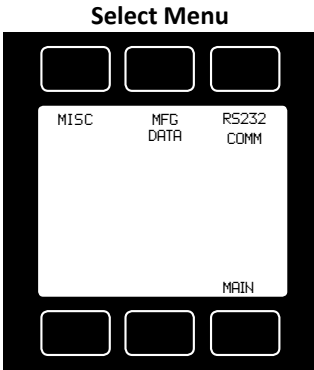

From **Select Menu** you can interact with your RS-232 / RS-485 settings or read manufacturer's data. Push **MAIN** to return to the Main display.

**Note:** P-Series Pressure Gauges may also be ordered as portable devices as described on page 47.



## MAIN

This mode defaults on power up, with flow as the primary displayed parameter. The following parameters are displayed in the Main mode.

**Line Pressure** shows the pressure in the units specified at time of order.

**Tare:** Pushing the **TARE P** button tares the pressure gauge and provides it with a reference point for zero pressure.

This is an important step in obtaining accurate measurements. It is best to zero the pressure gauge each time it is

powered up. If the pressure reading varies significantly from zero after an initial tare, give the unit a minute or so to warm up and re-zero it.

If in doubt about whether the pressure is zero, remove the gauge from the line and open both ports to atmosphere before entering the Tare command. For liquid pressure devices, all liquid must be drained from the gauge and any plumbing between the gauge and the atmosphere.

If the unit reads significantly different than zero when it is exposed to atmospheric pressure, it is a good indication that it was given a false tare.



**Do Not Attempt To Tare Absolute Pressure (psia) Instruments!**

**MENU:** Pressing **MENU** switches the screen to the **Select Menu** display.



**Flashing Error Message:** An error message (**POV** = pressure overrange) flashes when pressure exceeds the range of the sensor. When any item flashes, the pressure measurement is not accurate. Reducing the pressure to within specified limits will return the unit to normal operation and accuracy.

**If the unit does not return to normal operation contact Alicat.**



## SELECT MENU

From Select Menu you can interact with your RS-232 / RS-485 settings or read manufacturer's data.

Press the button next to the desired operation to bring that function to the screen.

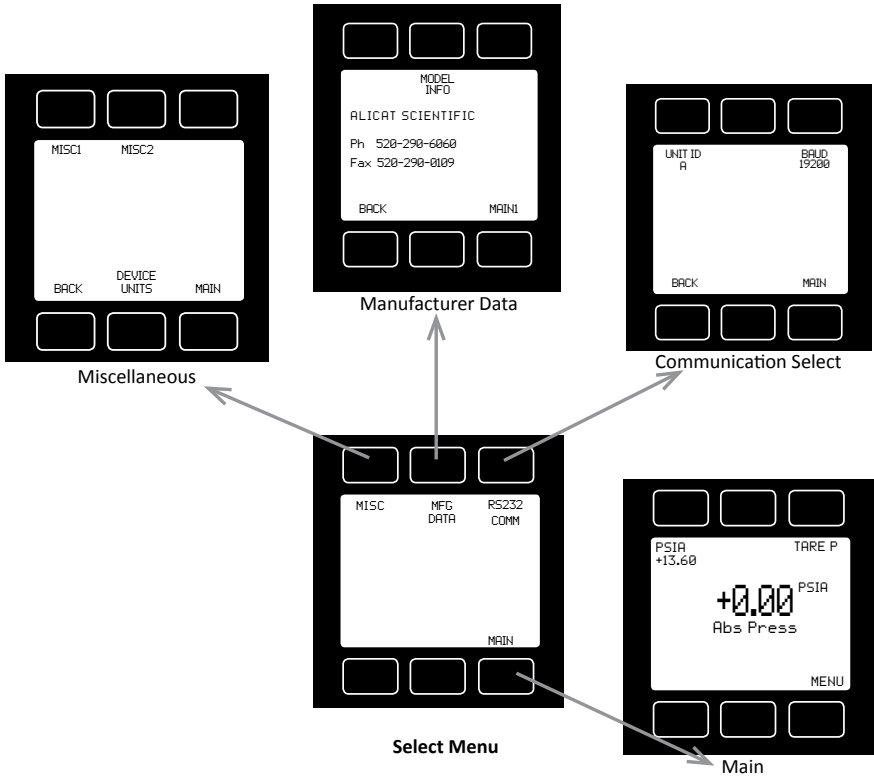

An explanation for each screen can be found on the following pages.

## COMMUNICATION SELECT

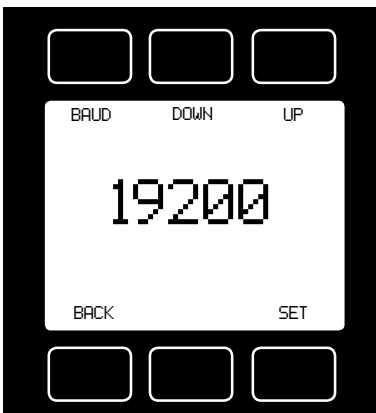
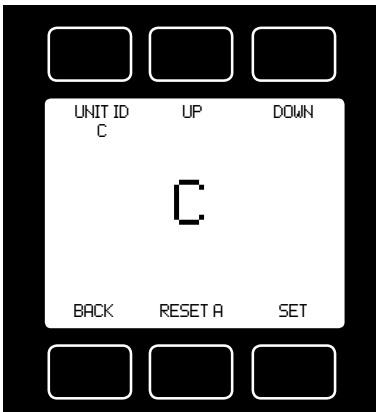
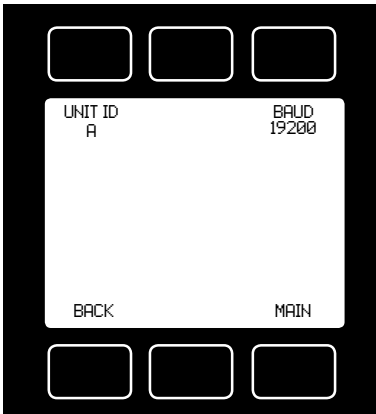

Access **Communication Select** by pressing the button above **RS232 COMM** or **RS485 COMM** on the **Select Menu** display.

**Unit ID** – Valid unit identifiers are the letters A-Z and @. The identifier allows you to assign a unique address to each device so that multiple units can be connected to a single RS-232 or RS-485 computer port.

Press **UNIT ID**. Use the UP and DOWN buttons to change the Unit ID. Press SET to record the ID. Press Reset to return to the previously recorded Unit ID.

**Any Unit ID change will take effect when Communication Select is exited.**

***If the symbol @ is selected as the Unit ID, the device will enter streaming mode when Communication Select is exited. See RS-232 Communications (page 36) for information about the streaming mode.***

**Baud** – Both this instrument and your computer must send/receive data at the same baud rate. The default baud rate for this device is 19200 baud.

Press the Select button until the arrow is in front of **Baud**. Use the UP and DOWN buttons to select the baud rate that matches your computer. The choices are 38400, 19200, 9600, or 2400 baud.

**Any baud rate change will not take effect until power to the unit is cycled.**

## MISCELLANEOUS

**Miscellaneous** is accessed by pressing the **MISC** button on the Select Menu display. Next select either **MISC1** or **MISC2**.

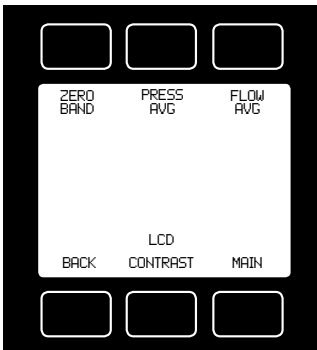

**MISC1** will display as shown at left.

**ZERO BAND** refers to Display Zero Deadband.

Zero deadband is a value below which the display jumps to zero. This deadband is often desired to prevent electrical noise from showing up on the display as minor flows or pressures that do not exist. Display Zero Deadband does not affect the analog or digital signal outputs.

**ZERO BAND** can be adjusted between 0 and 6.3% of the sensor's Full Scale (FS).

Press **ZERO BAND**. Then use SELECT to choose the digit with the arrow and the UP and DOWN buttons to change the value. Press SET to record your value. Press CLEAR to return to zero.

**Pressure Averaging and Flow Averaging** may be useful to make it easier to read and interpret rapidly fluctuating pressures and flows. Pressure and flow averaging can be adjusted between 1 (no averaging) and 256 (maximum averaging).

These are geometric running averages where the number between 1 and 256 can be considered roughly equivalent to the response time constant in milliseconds.

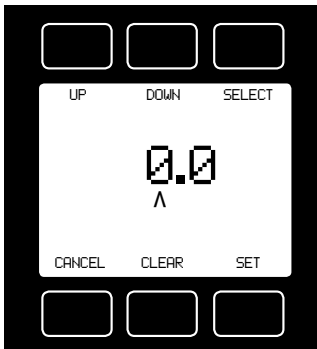

This can be effective at "smoothing" high frequency process oscillations such as those caused by diaphragm pumps.

Press **PRESS AVG**. Then use SELECT to choose the digit with the arrow and the UP and DOWN buttons to change the value. Press SET to record your value. Press CLEAR to return to zero.

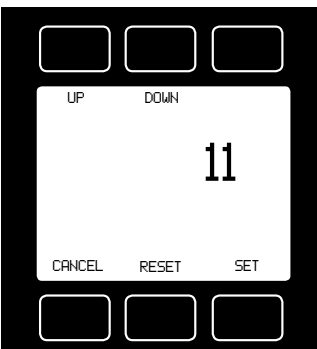

Press **FLOW AVG**. Then use SELECT to choose the digit with the arrow and the UP and DOWN buttons to change the value. Press SET to record your value. Press CLEAR to return to zero.

Setting a higher number will equal a smoother display.

**LCD CONTRAST:** The display contrast can be adjusted between 0 and 31, with zero being the lightest and 31 being the darkest. Use the UP and DOWN buttons to adjust the contrast. Press SET when you are satisfied. Press CANCEL to return to the MISC display.

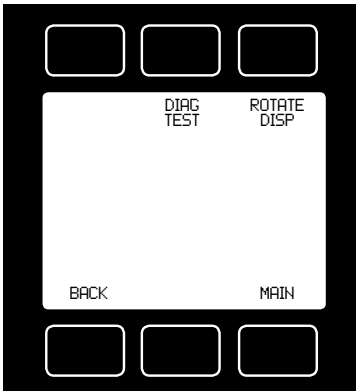

**MISC2** will display as shown at left.

Press **ROTATE DISP** and SET to **Inverted 180°** if your device is inverted. The display and buttons will rotate together.



**DIAG TEST:** This diagnostic screen displays the current internal register values, which is useful for noting factory settings prior to making any changes. It is also helpful for troubleshooting with Alicat customer service personnel.

Select the **DIAG TEST** button from the **MISC2** screen to view a list of select register values.

Pressing the **SCROLL** button will cycle the display through the register screens. An example screen is shown at left.

## DEVICE UNITS

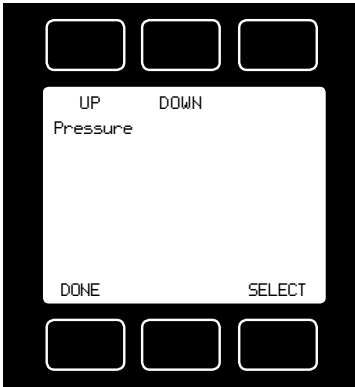

Press **DEVICE UNITS** to access menus of units of measure for each parameter (and totalizer if so equipped).

Scroll to the desired unit and press select. Once selected, you will see the message shown below. Verify that all connected devices expect the change.

See page 44 for a full list of available units.

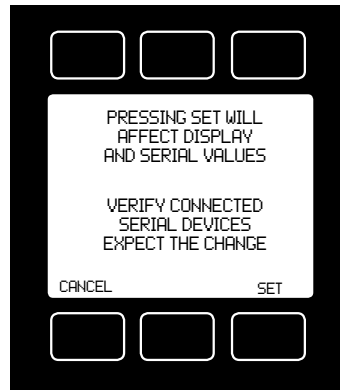
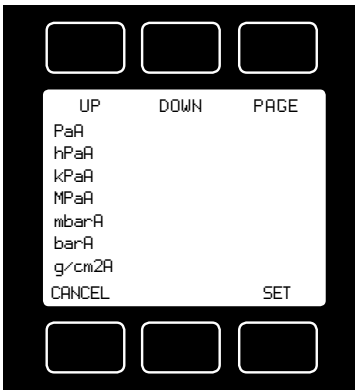

## MANUFACTURER DATA

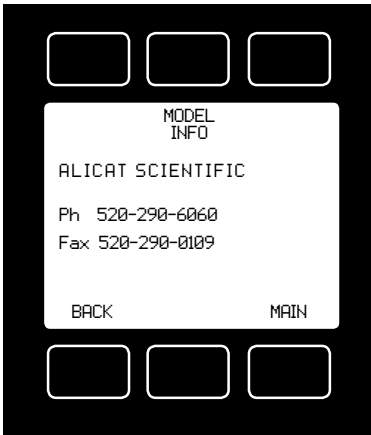

**Manufacturer Data** is accessed by pressing the **MFG DATA** button on the Select Menu display.

The initial display shows the name and telephone number of the manufacturer.

Press **MODEL INFO** to show important information about your flow device including the model number, serial number, and date of manufacture.

Press **BACK** to return to the MFG DATA display.

Push **MAIN** to return to the Main display.

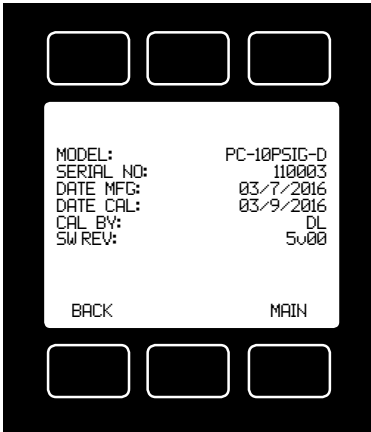

# DISPLAYS AND MENUS PC AND PCR CONTROLLERS

(Displays and Menus for P Gauges are shown beginning page 15.)

The device screen defaults to **Main** display as soon as power is applied to the controller.



The **Main** display shows, temperature and volume flow. Line pressure will be also be displayed if the meter was order with this option.

Pressing the button adjacent to a parameter will make that parameter the primary display unit.

By hitting the **MENU** button at the bottom right of the screen you will enter the **Select Menu** display.

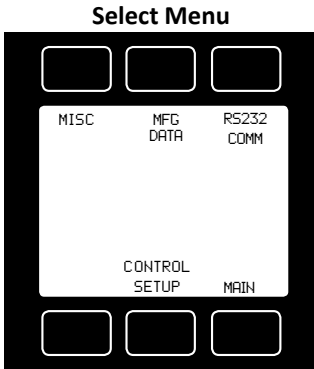

## Select Menu

From **Select Menu** you can interact with your RS-232 / RS-485 settings, read manufacturer's data or access the control set-up display.

Push **MAIN** to return to the Main display.

## MAIN



This mode defaults on power up, with flow as the primary displayed parameter.

The following parameters are displayed in the Main mode.

**Line Pressure** shows the pressure in the units specified at time of order.

**Set Point:** The set-point (**SETPT**) is shown in the upper right of the display.

**For information on changing the set-point see SETPT SOURCE, page 26.**

**MENU:** Pressing **MENU** switches the screen to the **Select Menu** display.



**Flashing Error Message:** An error message (**POV** = pressure overrange) flashes when pressure exceeds the range of the sensor. When any item flashes, the pressure measurement is not accurate. Reducing the pressure to within specified limits will return the unit to normal operation and accuracy.

**If the unit does not return to normal operation contact Alicat.**



## SELECT MENU

From Select Menu you can change the selected gas, interact with your RS-232 / RS-485 settings, read manufacturer's data and access the control setup screen.

Press the button next to the desired operation to bring that function to the screen.

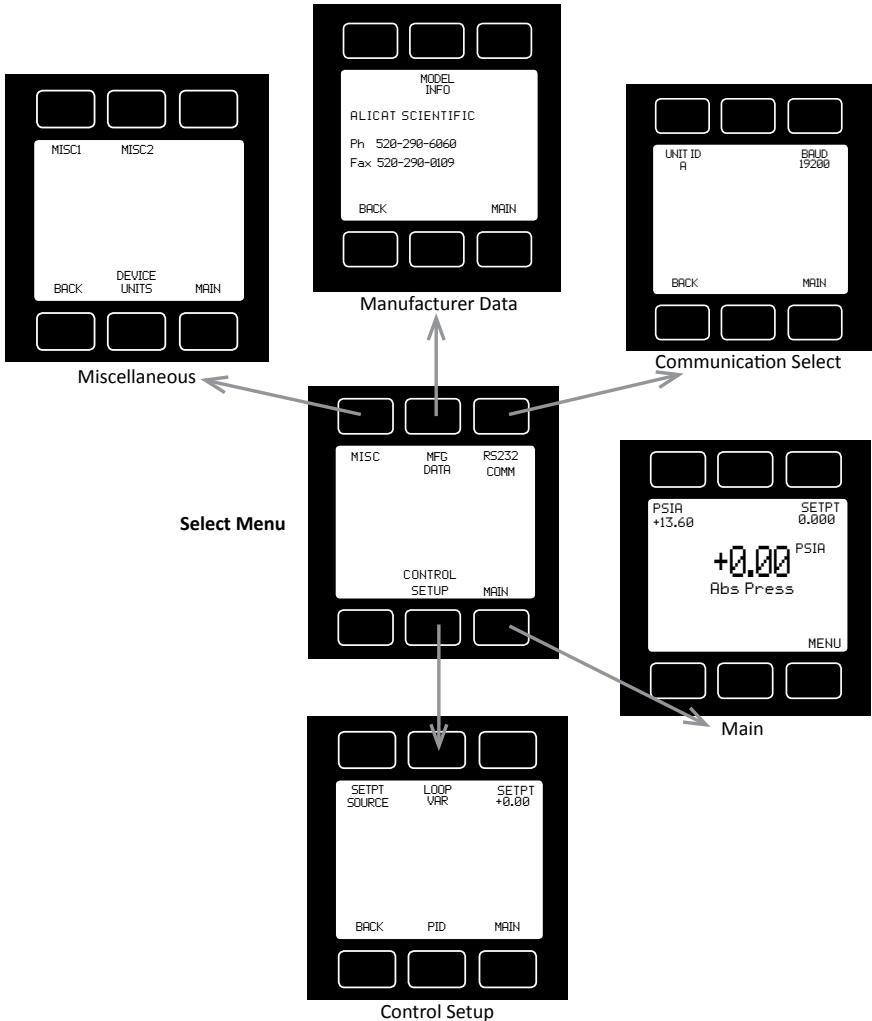

An explanation for each screen can be found on the following pages:

**Control Setup:** Please see page 26.

**Communication Select:** Please see page 18.

**Miscellaneous:** Please see page 19.

**Manufacturer Data:** Please see page 22.

## CONTROL SETUP

**Control Setup** is accessed by pressing the button below Control Setup on the Select Menu display. From this screen you can select your set-point source, choose a loop variable and adjust the PID terms.

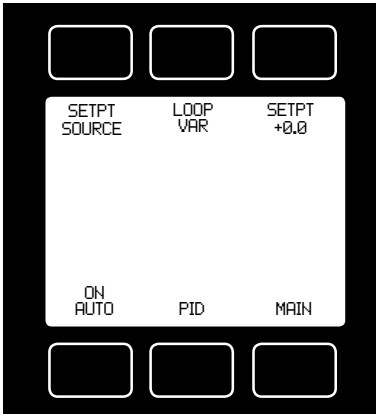

Press BACK to return to the Select Menu display.

Press MAIN to return to the MAIN display

**SETPT SOURCE** – Pressing the button above SETPT SOURCE will allow you to select how the set point will be conveyed to your controller.

Use the line-up and line-down buttons to move the arrow in front of the desired option. Then press SET.

Press CANCEL to return to the previous display.

The controller will ignore any set-point except that of the selected set-point source and it will remember which input is selected even if the power is disconnected.

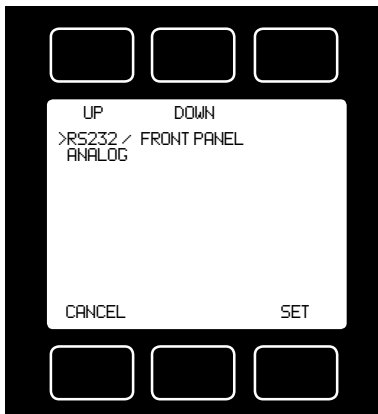

**RS-232 (or RS-485)** refers to a remote digital RS-232 / RS-485 set-point applied via a serial connection to a computer or PLC as described in the installation and RS-232 / RS-485 sections of this manual.

**Front Panel** refers to a set-point applied directly at the controller.

 **Front Panel input must be selected prior to changing the set-point at the device.**

**Analog** refers to a remote analog set-point applied to Pin 4 of the Mini-DIN connector as described in the installation

section of this manual. **The standard analog input is 0-5 Vdc.**

 **To determine what type of analog set-point your controller has, refer to the Calibration Data Sheet that was included with your controller.**

If nothing is connected to Pin 4, and the controller is set for analog control, the device will generate random set-point values.

**NOTE:** If your controller has the IPC (Integrated Potentiometer Control) option, the IPC dial will operate with the ANALOG set-point source selected.

**SETPT** refers to the **set-point**. This parameter may be changed using the display only if **FRONT PANEL** is selected as the Input. Press **SETPT**. Then use SELECT to choose the decimal with the arrow and the UP and DOWN buttons to change the value. Press SET to record your value. Press CLEAR to return to zero.



**CAUTION! NEVER LEAVE A CONTROLLER WITH A NON-ZERO SET-POINT IF NO PRESSURE IS AVAILABLE TO MAKE FLOW. THE CONTROLLER WILL APPLY FULL POWER TO THE VALVE IN AN ATTEMPT TO REACH THE SET-POINT. WHEN THERE IS NO FLOW, THIS CAN MAKE THE VALVE VERY HOT!**

### CONTROL SETUP (continued)

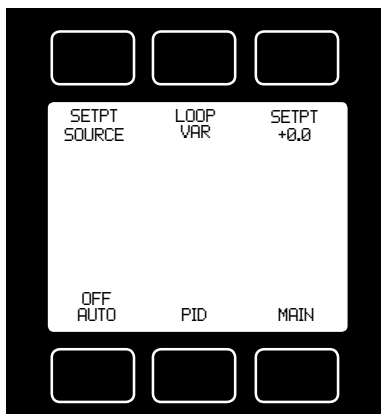

**LOOP VAR**—Pressure controllers are defaulted to pressure.

Pressure means that the controller is “closing the loop” on the pressure. This means that when you give the controller a set-point, the controller compares that set-point to the measured pressure and adjusts the valve to try to make the pressure and the set-point match. For the pressure, the input signal (e.g. 0-5 Vdc) corresponds to the full-scale pressure for the device.



## CONTROL SETUP (continued)

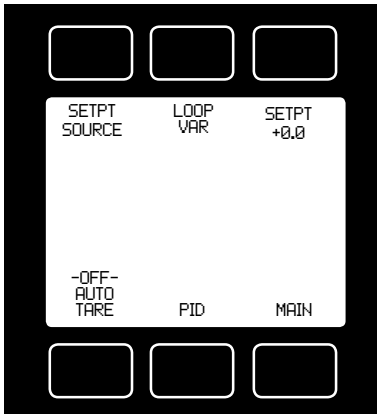

**Tareing** (or zeroing) a **gauge pressure** or **differential pressure** controller provides it with a reference point for zero pressure.

**OFF AUTO / ON AUTO**—this feature allows you to tare the controller.

*The controller must be left in the default OFF AUTO mode except when actually taring the controller as explained below.*

It is, however, very important to perform this adjustment only when you are certain that the process ports are open to atmosphere and that there is **No Flow!**

For liquid pressure devices, all liquid must be drained from the system.

To correctly tare a gauge pressure or differential pressure controller:

1. Be sure the unit is in the OFF AUTO default setting.
2. Disconnect all plumbing and make sure there is No Flow.
3. Push the button below OFF AUTO once so that the display reads ON AUTO.
4. Enter a Set-Point of ZERO. A zero set-point results in the closing of the valve and a known “no flow” condition.
5. Wait at least 30 seconds.
6. Push the button below ON AUTO once so that the display reads OFF AUTO.
7. Reconnect the plumbing.



***If the unit reads significantly different than zero, when removed from the line and open, it is a good indication that it was given a false zero.***



***If your pressure controller was ordered with the optional “Tare-P”, you may tare it following the instructions for taring a pressure gauge on page 16***



**Do Not Attempt To Tare Absolute Pressure (psia) Instruments!**

## PID TUNING

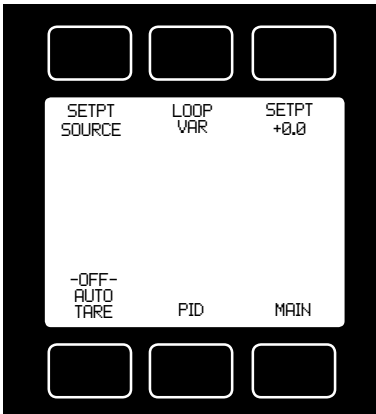

PID Values determine the performance and operation of your proportional control valve. These terms dictate control speed, control stability, overshoot and oscillation. All units leave the factory with a generic tuning designed to handle most applications. If you encounter issues with valve stability, oscillation or speed, fine tuning these parameters may resolve the problem.

Alicat controllers allow you to adjust the Proportional, Integral and Differential terms of the PID control loop.

To change the PID loop parameters, push the button below **PID**.

Press **LOOP TYPE**. Then use the UP and DOWN buttons to select the appropriate PID control algorithm. Press SET.

*See the following page for descriptions of the PID Loop Types (PID Control Algorithms).*

**P** refers to the Proportional term of the PID loop.

**I** refers to the Integral term of the PID loop.

**D** refers to the Differential term of the PID loop.

Press P, I or D. Then use SELECT to choose the decimal with the arrow and the UP and DOWN buttons to change the value. Press SET to record your value. Press CLEAR to return to zero.



**Before changing the P, I or D parameter, please record the initial value so that it can be returned to the factory setting if necessary.**

**Valve tuning can be complex. If you would like assistance, please contact Alicat for technical support.**

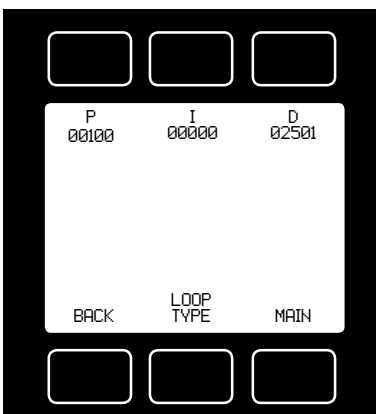
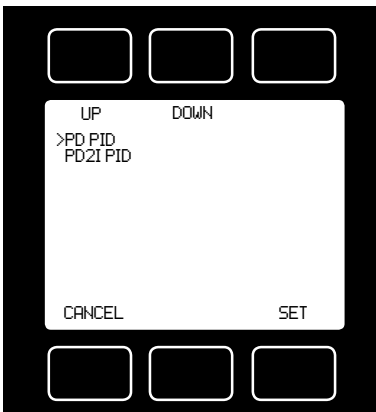

Overview of PID Adjustment on Alicat MFCs and Pressure Controllers  
<http://www.alicat.com/support/instructional-videos/>

***The PD algorithm is the PID algorithm used on most Alicat controllers.***

It is divided into two segments:

The first compares the process value to the set-point to generate a proportional error. The proportional error is multiplied by the 'P' gain, with the result added to the output drive register.

The second operates on the present process value minus the process value during the immediately previous evaluation cycle. This 'velocity' term is multiplied by the 'D' gain, with the result subtracted from the output drive register.

The above additions to and subtractions from the output drive register are carried over from process cycle to process cycle, thus performing the integration function automatically.

Increasing the 'P' gain will **promote** the tendency of the system to overshoot, ring, or oscillate.

Increasing the 'D' gain will **reduce** the tendency of the system to overshoot.

***The PD21 algorithm is a PID algorithm used primarily for high performance pressure and flow control applications.***

It exhibits two basic differences from the PD algorithm that most controllers utilize.

1. Instead of applying a damping function based upon the rate of change of the process value, it applies a damping function based upon the square of the rate of change of the process value.
2. The damping function is applied directly to the proportional error term before that term is used in the proportional and integral functions of the algorithm. This provides a certain amount of 'look ahead' capability in the control loop.

*Because of these differences, you will note the following:*

1. Increasing 'P' gain can be used to damp out overshoot and slow oscillations in pressure controllers. You will know that 'P' gain is too high, when the controller breaks into fast oscillations on step changes in set-point. On flow controllers, too high a 'P' gain results in slower response times. Too low a 'P' gain results in overshoot and/or slow oscillation. A good starting value for 'P' gain is 200.
2. If the unit was originally shipped with the PD21 algorithm selected, the 'D' gain value should be left at or near the factory setting because it relates primarily to the system phase lags. If you are changing from the default algorithm to the PD21 algorithm, you should start with a 'D' gain value of 20.
3. The 'I' gain is used to control the rate at which the process converges to the set-point, after the initial step change. Too low a value for 'I' gain shows up as a process value that jumps to near the set-point and then takes awhile to converge the rest of the way. Too high a value for 'I' gain results in oscillation. A good starting value for the 'I' gain is 200.

## Pressure Control Application, Upstream Valve

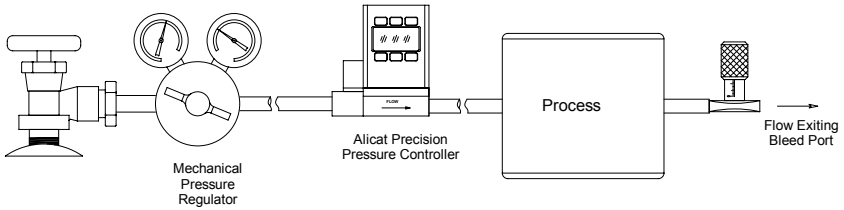

## Back Pressure Control Application, Downstream Valve (DS) Specify DS in part number adder code

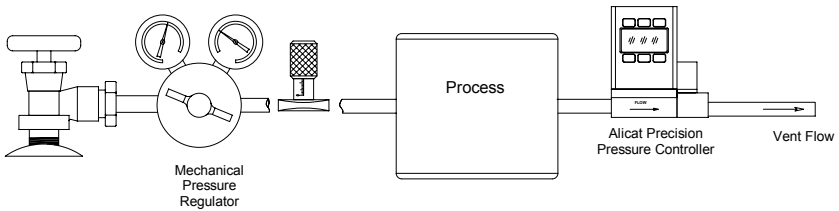

## Upstream and Downstream Valve Diagram



**Changing Valve Position On Alicat Small Valve Mass Flow And Pressure Controllers**  
<http://www.alicat.com/support/instructional-videos/>

### PC3 AND PCR3 SERIES PRESSURE CONTROLLERS:

The PC3, PCD3, PCR3 and PCRD3 Series pressure controller is designed to change the flow to allow the control of pressure at some point away from the body of the controller.

This is most helpful when it is necessary to mount pneumatic components such as valves, fittings or flow meters that introduce significant pressure drop between pressure controller body and the point where pressure control is necessary.

To accomplish this, the PC3 has an external sensing port to which the pressure at the location where pressure is to be controlled is piped back to the pressure sensor in the controller.

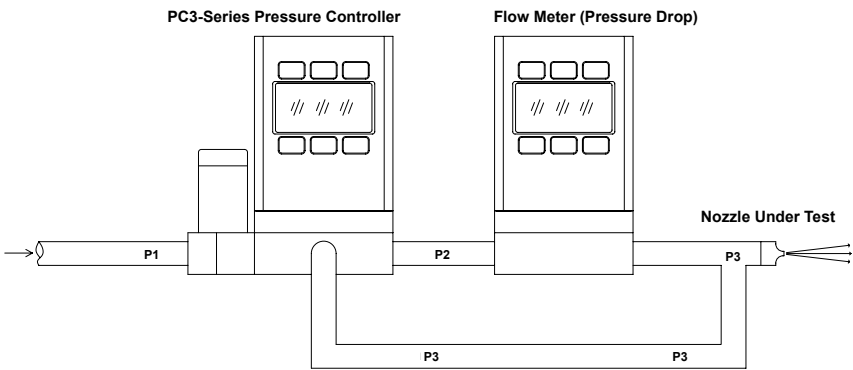

Typical PC3 Application



## DIFFERENTIAL PRESSURE GAUGES:

The differential pressure gauge is designed to measure a pressure difference between two points in the line. There are a variety of applications for this device.

One of the most common is to measure the difference in pressure across some sort of element that changes resistance to flow over time, such as a filter, or one that changes area with time as would happen with orifice testing.

The gauge has two sensing ports which are piped to the upstream and downstream sides of the pressure drop of interest in the system.

These two ports run either to two separate pressure sensors or for low differential pressures – they may be run to the two legs of a single differential pressure sensor. The higher (upstream) pressure is applied to the left port and the lower (downstream) pressure is applied to the right port.

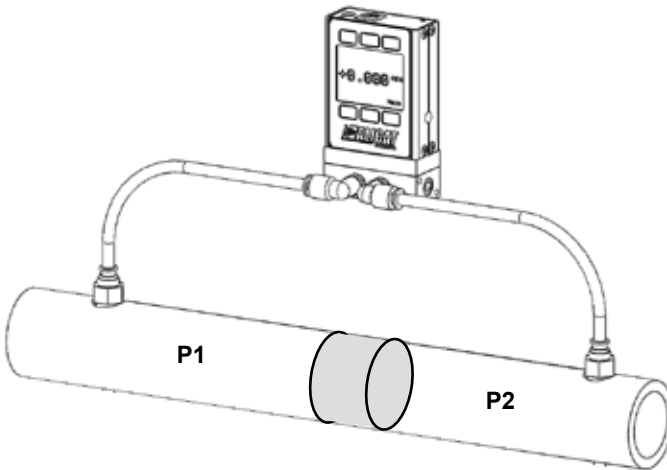
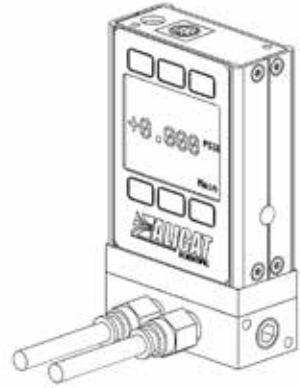

Differential Pressure Gauge Application

## DIFFERENTIAL PRESSURE CONTROLLERS:

The differential pressure controller is designed to change the flow to allow the control of a pressure difference between two points in the line. There are a variety of applications for this device.

One of the most common is to control the difference in pressure across some sort of element that changes resistance to flow over time, such as a filter or one that changes area with time as would happen with orifice testing. To accomplish differential pressure control, the controller has two sensing ports which are piped to the upstream and downstream sides of the pressure drop in the system.

These two ports run either to two separate pressure sensors or for low differential pressures – they may be run to the two legs of a single differential pressure sensor. The controller itself changes the flow to the two sensing ports until the difference between the two pressures matches the set-point.

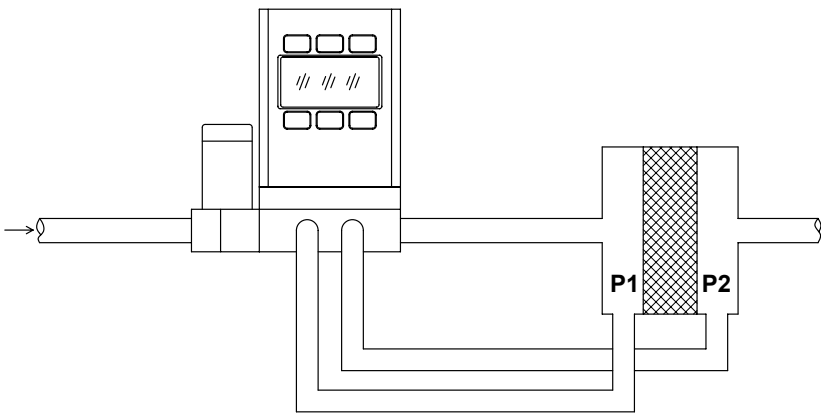

Differential Pressure Controller Application

## PCD-SERIES DUAL VALVE PRESSURE CONTROLLER OPERATION

Alicat Scientific PCD-Series Closed Volume Pressure Controllers incorporate a digital pressure gauge with dual control valves and circuitry. The integrated PID loop measures the pressure, compares it with the set-point, and adjusts either the Inlet or Exhaust valve accordingly in excess of two thousand times per second.

It is most common to have a .050 inch diameter orifice in the inlet valve, and a .050 inch diameter exhaust valve. The response time of the system will depend on the size of the volume being controlled and the feed pressure. The controllers are intended for use with clean, non-corrosive gases only.

They are designed with a feed port, a process port, and an exhaust port. This allows the controllers to raise and lower the pressure of a closed system within the operating range of the controller without wasting gas under constant pressure conditions.

### Plumbing

Connect your PCD into your process via the 1/8" NPT port on the front of the unit. This is the "Process" port.

Connect a supply pressure greater than the full scale pressure control range of the device, not to exceed 145 psig, to the inlet 1/8" NPT port on the left side device. This is the "Inlet" port.

The 1/8" NPT "Exhaust" port, located on the right side of the device can vent to atmosphere if the application is suitable, or to a collection network if necessary.

The pressure at the exhaust port should be at atmospheric pressure or below to allow the controller to be used over its full scale range.

If desired, there are two 8-32 mounting holes located on the bottom of the unit as shown in the dimensional drawing on page 61.

Connect your PCD to power and output lines as detailed on pages 9 - 12.

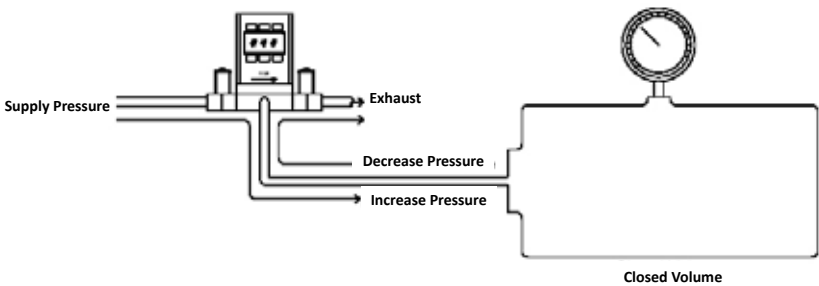

Typical PCD Plumbing Diagram

## RS-232 / RS-485 OUTPUT AND INPUT

### Configuring HyperTerminal®:

1. Open your HyperTerminal® RS-232 / RS-485 terminal program (installed under the “Accessories” menu on all Microsoft Windows® operating systems).
2. Select “Properties” from the file menu.
3. Click on the “Configure” button under the “Connect To” tab. Be sure the program is set for: 19,200 baud (or matches the baud rate selected in the RS-232 / RS-485 communications menu on the meter) and an 8-N-1-None (8 Data Bits, No Parity, 1 Stop Bit, and no Flow Control) protocol.
4. Under the “Settings” tab, make sure the Terminal Emulation is set to ANSI or Auto Detect.
5. Click on the “ASCII Setup” button and be sure the “Send Line Ends with Line Feeds” box is not checked and the “Echo Typed Characters Locally” box and the “Append Line Feeds to Incoming Lines” boxes are checked. Those settings not mentioned here are normally okay in the default position.
6. Save the settings, close HyperTerminal® and reopen it.

### Streaming Mode (RS-485 units do not have a streaming mode)

In the **default** Polling Mode, the screen should be blank except the blinking cursor. In order to get the data streaming to the screen, hit the “Enter” key several times to clear any extraneous information. Type “\* @=@” followed by “Enter” (or using the RS-232 / RS-485 communication select menu, select @ as identifier and exit the screen). If data still does not appear, check all the connections and COM port assignments.

### Streaming Mode – Advanced

The streaming data rate is controlled by register 91. The recommended default rate of data provision is once every 50 milliseconds and this is suitable for most purposes. If a slower or faster streaming data rate is desired, register 91 can be changed to a value from 1 millisecond to 65535 milliseconds, or slightly over once every minute. Below approximately 40 milliseconds, data provision will be dependent upon how many parameters are selected. Fewer data parameters can be streamed more quickly than more. It is left to the user to balance streaming speed with number of parameters streamed.

To read register 91, type “\*r91” followed by “Enter”.

To modify register 91, type “\*w91=X”, where X is a positive integer from 1 to 65535, followed by “Enter”.

To return to the recommended factory default streaming speed, type “\*w91= 50”.

### **Tareing via RS-232 / RS-485 (Gauges only):**

Tareing (or zeroing) the pressure gauge provides it with a reference point for zero pressure. This is a very simple but important step in obtaining accurate measurements. It is good practice to “zero” the pressure gauge each time it is powered up. If the pressure reading varies significantly from zero after an initial tare, give the unit a minute or so to warm up and re-zero it.

Zeroing the unit while there is any pressure will directly affect the accuracy by providing a false zero point. If in doubt about whether the pressure is zero, remove it from the line and open both ports to atmosphere before entering the Tare command.

If the unit reads a significant negative value when removed from the line and open, it is a good indication that it was given a false zero. To send a Tare command via RS-232 / RS-485, enter the following strings:

In Polling Mode:                      Address\$\$P<Enter>      (e.g. B\$\$P<Enter>)

**Sending a Set-point via RS-232 / RS-485:** To send a set-point via RS-232 / RS-485, “Serial” must be selected under the “Input” list in the control set up mode.

**Method 1:** Set-point may be set in floating point in serial communication using serial command (UnitID)SX.YZ

Example: AS4.54 results in Unit ID A changing set-point to 4.54.

**Method 2:** Type in a number between 0 and 65535 (2% over range), where 64000 denotes full-scale flow rate, and hit “Enter”.

The set-point column and pressure rates should change accordingly. If they do not, try hitting “Enter” a couple of times and repeating your command. The formula for performing a linear interpolation is as follows:

$$\text{Value} = (\text{Desired Set-point} \times 64000) / \text{Full Scale Pressure Range}$$

For example, if your device is a 50 psig full-scale unit and you wish to apply a set-point of 12.5 psig you would enter the following value:

$$16000 = (12.5 \text{ psig} \times 64000) / \text{Full Scale Pressure Range}$$

If the controller is in polling mode as described in Changing from Streaming Mode to Polling Mode, the set-point must be preceded by the address of the controller. For example, if your controller has been given an address of D, the set-point above would be sent by typing:

D16000 followed by “Enter”

**To adjust the Proportional and Differential (P&D) terms via RS-232 / RS-485 (PC and PCR-Series only):**

Type \***@**=A followed by “Enter” to stop the streaming mode of information.

To adjust the “P” or proportional term of the PID controller, type \***R21** followed by “Enter”.

The computer will respond by reading the current value for register 21 between 0-65535. It is good practice to write this value down so you can return to the factory settings if necessary. Enter the value you wish to try by writing the new value to register 21. For example, if you wished to try a “P” term of 220, you would type \***W21=220** followed by “Enter” where the bold number denotes the new value.

The computer will respond to the new value by confirming that 21=220. To see the effect of the change you may now poll the unit by typing A followed by “Enter”. This does an instantaneous poll and returns the values once. You may type A “Enter” as many times as you like. Alternately, you could resume streaming mode by typing \***@=@** followed by “Enter”. Repeat step 3 to remove the unit from the streaming mode.

To adjust the “D” or proportional term of the PID controller, type \***R22** followed by “Enter”.

The computer will respond by reading the current value for register 22 between 0-65535. It is good practice to write this value down so you can return to the factory settings if necessary. Enter the value you wish to try by writing the new value to register 22. For example, if you wished to try a “D” term of 25, you would type \***W22=25** followed by “Enter” where the bold number denotes the new value.

The computer will respond to the new value by confirming that 22=25. To see the effect of the change you may now poll the unit by typing A followed by “Enter”. This does an instantaneous poll and returns the values once. You may type A “Enter” as many times as you like. Alternately you could resume streaming mode by typing \***@=@** followed by “Enter”. Repeat.

You may test your settings for a step change by changing the set-point. To do this type A32000 (A is the default single unit address, if you have multiple addressed units on your RS-232 / RS-485 line the letter preceding the value would change accordingly.) followed by “Enter” to give the unit a ½ full scale set-point. Monitor the unit’s response to the step change to ensure it is satisfactory for your needs. Recall that the “P” term controls how quickly the unit goes from one set-point to the next, and the “D” term controls how quickly the signal begins to “decelerate” as it approaches the new set-point (controls the overshoot).

## Changing From Streaming to Polling Mode:

When the meter is in the Streaming Mode (*RS-485 units do not have a streaming mode*), the screen is updated approximately 10-60 times per second (depending on the amount of data on each line) so that the user sees the data essentially in real time. It is sometimes desirable, and necessary when using more than one unit on a single RS-232 line, to be able to poll the unit.

In Polling Mode the unit measures the flow normally, but only sends a line of data when it is "polled". Each unit can be given its own unique identifier or address. Unless otherwise specified each unit is shipped with a default address of capital A. Other valid addresses are B thru Z.

Once you have established communication with the unit and have a stream of information filling your screen:

1. Type `*@=A` followed by "Enter" (or using the RS-232 / RS-485 communication select menu, select A as identifier and exit the screen) to stop the streaming mode of information. Note that the flow of information will not stop while you are typing and you will not be able to read what you have typed. Also, the unit does not accept a backspace or delete in the line so it must be typed correctly. If in doubt, simply hit enter and start again. If the unit does not get exactly what it is expecting, it will ignore it. If the line has been typed correctly, the data will stop.
2. You may now poll the unit by typing A followed by "Enter". This does an instantaneous poll of unit A and returns the values once. You may type A "Enter" as many times as you like. Alternately you could resume streaming mode by typing `*@=@` followed by "Enter". Repeat step 1 to remove the unit from the streaming mode.
3. To assign the unit a new address, type `*@=New Address`, e.g. `*@=B`. Care should be taken not to assign an address to a unit if more than one unit is on the RS-232 / RS-485 line as all of the addresses will be reassigned. Instead, each should be individually attached to the RS-232 / RS-485 line, given an address, and taken off. After each unit has been given a unique address, they can all be put back on the same line and polled individually.

## Collecting Data:

The RS-232 / RS-485 output updates to the screen many times per second. Very short-term events can be captured simply by disconnecting (there are two telephone symbol icons at the top of the HyperTerminal® screen for disconnecting and connecting) immediately after the event in question. The scroll bar can be driven up to the event and all of the data associated with the event can be selected, copied, and pasted into Microsoft® Excel® or other spreadsheet program as described below.

For longer term data, it is useful to capture the data in a text file. With the desired data streaming to the screen, select “Capture Text” from the Transfer Menu. Type in the path and file name you wish to use. Push the start button. When the data collection period is complete, simply select “Capture Text” from the Transfer Menu and select “Stop” from the sub-menu that appears.

Data that is selected and copied, either directly from HyperTerminal® or from a text file can be pasted directly into Excel®. When the data is pasted it will all be in the selected column. Select “Text to Columns...” under the Data menu in Excel® and a Text to Columns Wizard (dialog box) will appear. Make sure that “Fixed Width” is selected under Original Data Type in the first dialog box and click “Next”. In the second dialog box, set the column widths as desired, but the default is usually acceptable. Click on “Next” again. In the third dialog box, make sure the column data format is set to “General”, and click “Finish”. This separates the data into columns for manipulation and removes symbols such as the plus signs from the numbers. Once the data is in this format, it can be graphed or manipulated as desired.



***For extended term data capture see:*** “Sending a Simple Script to HyperTerminal®” on page 42.



**Data Format:**

The data stream on the screen represents the pressure parameters of the main mode in the units shown on the display. For P-Series Pressure Gauges, there is a single column of data. This column represents the measured pressure in the units specified at time of order and shown on the display.

+4.123  
+4.123  
+4.123  
+4.123  
+4.124  
+4.125

P-Series Pressure Gauge Data Format

For PC-Series Controllers, there are 2 columns of data representing pressure and set-point. The first column is pressure (normally in psig), the second column is the set-point (in the units specified at time of order and shown on the display).

+014.70 014.70  
+014.70 014.70  
+014.70 014.70  
+014.70 014.70  
+014.70 014.70  
+014.70 014.70

PC-Series Vacuum and Pressure Controller Data Format

## Sending a Simple Script File to HyperTerminal®

It is sometimes desirable to capture data for an extended period of time. Standard streaming mode information is useful for short term events, however, when capturing data for an extended period of time, the amount of data and thus the file size can become too large very quickly. Without any special programming skills, you can use HyperTerminal® and a text editing program such as Microsoft® Word® to capture text at defined intervals.

1. Open your text editing program, MS Word for example.
2. Set the cap lock on so that you are typing in capital letters.
3. Beginning at the top of the page, type A<Enter> repeatedly. If you're using MS Word, you can tell how many lines you have by the line count at the bottom of the screen. The number of lines will correspond to the total number of times the flow device will be polled, and thus the total number of lines of data it will produce.

For example:     A  
                  A  
                  A  
                  A  
                  A  
                  A  
                  A

will get a total of six lines of data from the flow meter, but you can enter as many as you like.

The time between each line will be set in HyperTerminal.

4. When you have as many lines as you wish, go to the File menu and select save. In the save dialog box, enter a path and file name as desired and in the "Save as Type" box, select the plain text (.txt) option. It is important that it be saved as a generic text file for HyperTerminal to work with it.
5. Click Save.
6. A file conversion box will appear. In the "End Lines With" drop down box, select CR Only. Everything else can be left as default.
7. Click O.K.
8. You have now created a "script" file to send to HyperTerminal. Close the file and exit the text editing program.
9. Open HyperTerminal and establish communication with your flow device as outlined in the manual.
10. Set the flow device to Polling Mode as described in the manual. Each time you type A<Enter>, the meter should return one line of data to the screen.
11. Go to the File menu in HyperTerminal and select "Properties".
12. Select the "Settings" tab.

13. Click on the “ASCII Setup” button.

14. The “Line Delay” box is defaulted to 0 milliseconds. This is where you will tell the program how often to read a line from the script file you’ve created. 1000 milliseconds is one second, so if you want a line of data every 30 seconds, you would enter 30000 into the box. If you want a line every 5 minutes, you would enter 300000 into the box.

15. When you have entered the value you want, click on OK and OK in the Properties dialog box.

16. Go the Transfer menu and select “Send **Text** File...” (NOT Send File...).

17. Browse and select the text “script” file you created.

18. Click Open.

19. The program will begin “executing” your script file, reading one line at a time with the line delay you specified and the flow device will respond by sending one line of data for each poll it receives, when it receives it.

You can also capture the data to another file as described in the manual under “Collecting Data”. You will be simultaneously sending it a script file and capturing the output to a separate file for analysis.

**Supported Units:** This device supports many different units. You may select the desired units (see page 21). Note that only units appropriate to this device are available for selection.

**Pressure Units**

Absolute	Gauge	Differential	Notes
PaA	PaG	PaD	pascal
hPaA	hPaG	hPaD	hectopascal
kPaA	kPaG	kPaD	kilopascal
MPaA	MPaG	MPaD	megapascal
mbarA	mbarG	mbarD	millibar
barA	barG	barD	bar
g/cm2A	g/cm2G	g/cm2D	gram force per square centimeter
kg/cmA	kg/cmG	kg/cmD	kilogram force per square centimeter
PSIA	PSIG	PSID	pound force per square inch
PSFA	PSFG	PSFD	pound force per square foot
mTorrA	mTorrG	mTorrD	millitorr
torrA	torrG	torrD	torr
mmHgA	mmHgG	mmHgD	millimeter of mercury at 0 C
inHgA	inHgG	inHgD	inch of mercury at 0 C
mmH2OA	mmH2OG	mmH2OD	millimeter of water at 4 C (NIST conventional)
mmH2OA	mmH2OG	mmH2OD	millimeter of water at 60 C
cmH2OA	cmH2OG	cmH2OD	centimeter of water at 4 C (NIST conventional)
cmH2OA	cmH2OG	cmH2OD	centimeter of water at 60 C
inH2OA	inH2OG	inH2OD	inch of water at 4 C (NIST conventional)
inH2OA	inH2OG	inH2OD	inch of water at 60 C
atm			atmosphere
m asl			meter above sea level (only in /ALT builds)
ft asl			foot above sea level (only in /ALT builds)
V	volt; no conversions are performed to or from other units		
count	count	count	setpoint count, 0 – 64000
%	%	%	percent of full scale

**Valve Drive Units**

Label	Notes
count	+/- 65536 at full drive
%	Percent of full scale drive

## TROUBLESHOOTING

### ***Display does not come on or is weak.***

Check power and ground connections and supply voltage. Please reference the technical specifications (pages 54-69) to assure you have the proper power for your model.

### ***Pressure reading is approximately fixed either near zero or near full scale regardless of actual line pressure.***

Differential pressure sensor may be damaged. A common cause of this problem is instantaneous application of high-pressure gas as from a snap acting solenoid valve upstream of the meter. If you suspect that your pressure sensor is damaged please discontinue use of the controller and contact Alicat.

### ***Displayed pressure is flashing and message POV is displayed:***

Our pressure gauges and controllers display an error message (POV = pressure overrange) when a the pressure exceeds the range of the sensors in the device. When any item flashes on the display, the pressure measurement is not accurate. Reducing the pressure to within specified limits will return the unit to normal operation and accuracy. If the unit does not return to normal contact Alicat.

### ***My controller does not respond to the set-point.***

Check that your set-point signal is present and supplied to the correct pin and that the correct set-point source is selected under the SETPT SOURCE list in the control set up display (page 26). Also check that the unit is properly grounded.

### ***After installation, there is no pressure.***

Alicat Scientific PC-Series Controllers incorporate normally closed valves and require a set-point to operate. Check that your set-point signal is present and supplied to the correct pin and that the correct input is selected under the SETPT SOURCE list in the control set up display (page 26). Also check that the unit is properly grounded.

### ***The pressure lags below the set-point.***

Be sure there is enough pressure available. If either the set-point signal line and/or the output signal line is relatively long, it may be necessary to provide heavier wires (especially ground wiring) to negate voltage drops due to line wire length. An inappropriate PID tuning can also cause this symptom if the D term is too large relative to the P term. See pages 29 and 30 for more information on PID tuning.

### ***Controller is slow to react to a set-point change or imparts an oscillation to the flow.***

An inappropriate PID tuning can cause these symptoms. Use at conditions considerably different than those at which the device was originally set up can necessitate a re-tuning of the PID loop. See pages 29 and 30 for more information on PID tuning. Note: The larger the volume pressured, the longer it takes to change the pressure in that volume.

### ***The output signal is lower than the reading at the display.***

This can occur if the output signal is measured some distance from the gauge/controller as voltage drops in the wires increase with distance. Using heavier gauge wires, especially in the ground wire, can reduce this effect.

### ***My controller oscillates wildly and/or exhibits very different reactions to the set-point than I expect.***

Conditions considerably different than those at which the device was originally set up can necessitate a re-tuning of the PID loop. See pages 29 and 30 for more information on PID tuning.

***RS-232 / RS-485 Serial Communications is not responding.***

Check that your gauge is powered and connected properly. Be sure that the port on the computer to which the gauge is connected is active. Confirm that the port settings are correct per the RS-232 / RS-485 instructions in this manual (Check the RS-232 / RS-485 communications select screen for current gauge readings). Close HyperTerminal® and reopen it. Reboot your PC.

See pages 11, 12 and 36 for more information on RS-232 / RS-485 signals and communications.

***Slower response than specified.***

P-Series Gauges and PC-Series Controllers feature an RS-232 / RS-485 programmable Geometric Running Average (GRA). Depending on the full scale range of the gauge, it may have the GRA set to enhance the stability/readability of the display, which would result in slower perceived response time. Please see “Pressure Averaging” on page 19.

***Jumps to zero at low pressure.***

P-Series Gauges and PC-Series Controllers feature an RS-232 / RS-485 programmable zero deadband. The factory setting is usually 0.5% of full scale. This can be adjusted between NONE and 6.3% of full scale. See page 19.

## **MAINTENANCE AND RECALIBRATION**

**General:** P, PC, PCR and PCD-Series Pressure Gauges and Controllers require minimal maintenance. They have no moving parts. The single most important thing that affects the life and accuracy of these devices is the quality of the gas being measured. The instruments are designed to measure CLEAN, DRY, NON-CORROSIVE gases. If your application requires an aggressive or corrosive gas, please consider Alicat’s **PS, PCS, PCRS and PCDS Series** instruments (see page 64).

**Recalibration:** The recommended period for recalibration is once every year. A label located on the back of the controller lists the most recent calibration date. The controller should be returned to the factory for recalibration within one year from the listed date. Before calling to schedule a recalibration, please note the serial number on the back of the meter. The Serial Number, Model Number, and Date of Manufacture are also available on the Model Info display (page 22).

**Cleaning:** P, PC, PCR and PCD-Series Pressure Gauges and Controllers require no periodic cleaning. If necessary, the outside of the controller can be cleaned with a soft dry cloth. Avoid excess moisture or solvents.

For repair, recalibration or recycling of this product, contact:

Alicat Scientific, Inc.  
7641 N Business Park Drive  
Tucson, Arizona 85743  
USA  
Ph. 520-290-6060  
Fax 520-290-0109  
email: [info@alicat.com](mailto:info@alicat.com)  
Web site: [www.alicat.com](http://www.alicat.com)

## Alicat Portable Meters and Gauges

Alicat Rechargeable Flow Meters and Pressure Gauges use a Li-Ion 3.7V cell located in the top section of the device. **The Li-Ion cell must not be removed.**

Normal battery life of a fully-charged cell is 18 hours with a monochrome display or 5 hours with a TFT color display, when the backlight is set to 10. Dimming the backlight will increase battery life.

The battery can be charged through either the micro-USB port or the mini-DIN connector. When the device is connected to external power it will function normally while the battery is charging. **Note: If the battery has no charge, a charge time of one minute will be required before the unit can be turned on.** Charge rates will be fastest through the micro-USB port using the included power supply or equivalent. The device will charge fastest when it is turned off.

**Recharge Time:** 3.5 hours with 2A USB supply. The micro-USB port is for charging purposes only. The green/red indicator LED on top of the device will light up green to indicate that the unit is charging. The green LED will turn off when the battery is charged and the power switch is turned to "I" for ON.

A small lightning bolt symbol will display next to the battery symbol while the device is charging. It will no longer appear when the device is fully charged.

The indicator LED flashes red when the device has about 1 hour of battery life remaining. The LED will flash red at a faster rate when the device has about 15 minutes of battery life remaining. It is highly recommended that the device be charged immediately. When the battery charge runs out, the display contrast will turn to 0 and device performance is no longer guaranteed.



Output signals from the meter are passed through the mini-DIN connector on top of the device. Rechargeable battery units do not support 0-10V analog output. Receiver resistance must be below 250Ω.

**Turn the power switch on top of the device to "O" for OFF when it is not in use.**



**Warning:** If the device is left ON until the battery can no longer power it, the charge indicator will fall out of sync with the actual charge. The device can be re-synced by fully charging the battery once.

A Battery Charge Indicator appears below Tare on the display.

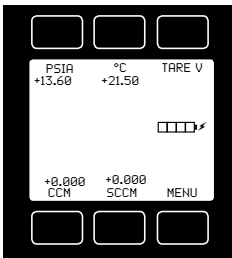

### TOP VIEW OF DEVICE

Green = Charging  
Flashing Red = Low Battery

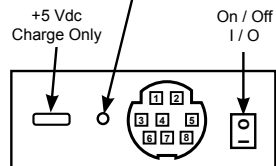

**CAUTION! DO NOT OPERATE OR STORE THE DEVICE OUTSIDE OF THE -10° TO +50°C TEMPERATURE RANGE. IF INTERNAL SENSORS DETECT THAT THE TEMPERATURE IS OUTSIDE OF THIS RANGE, THE DISPLAY CONTRAST WILL TURN TO 0 AND THE METER'S PERFORMANCE IS NO LONGER GUARANTEED.**

**THE SAFE CHARGING TEMPERATURE RANGE IS 0° TO +45°C. IF INTERNAL SENSORS DETECT TEMPERATURES OUTSIDE OF THIS RANGE, THE BATTERY WILL NOT CHARGE.**

## Pressure Menu for Portable Meters and Gauges

Alicat portable meters are programmed with additional pressure read options. Pressing the pressure button once (upper left) will move the pressure reading to the main display. Pressing the button a second time will open a menu of pressure read options. Scroll **UP** or **Down** and press **Select** to make a change.



When the pressure button is already using the device engineering units, the bottom menu option displays as **“Set device eng units”**.

When the pressure button is using something different than device engineering units (e.g., bar instead of PSI), the bottom menu option displays as **“Show device units”**.

The serial data line changes only when device engineering units are changed, and the instrument will prompt you to accept these changes to the serial line.

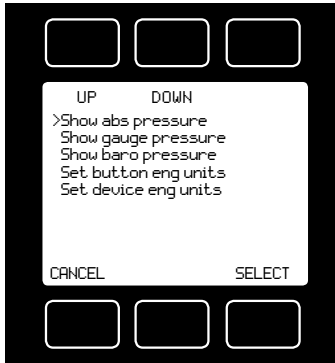

**TARE P w/BARO:** The stream absolute pressure sensor can be tared to the barometric pressure sensor. In this case, the absolute pressure is offset by the differential between the two readings. **TARE P w/BARO** can be accessed from the **MISC2** display.

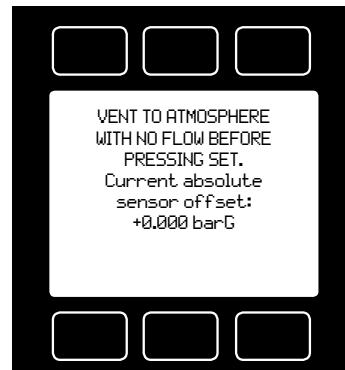
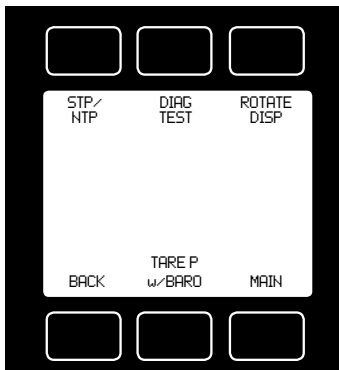



### Option: Remote Electronics for High Line or Gas Temperatures

Some applications involve operating temperatures outside the standard Alicat device specifications. A solution using remote electronics is available. (This option is not applicable for liquid devices.)

The flow body's components are minimized to only the required sensors. The flow data is sent to the microprocessor electronics up to 6 feet away from the sensor package.

Relocating the sensitive electronics allows for installation of the flow body in ambient temperatures as high as 85° Celsius with gas temperatures under 100° Celsius.

In these applications we recommend our custom gauge calibration at a gas temperature of up to 70° Celsius. This will reduce zero shift errors that occur when actual gas flow temperatures deviate substantially from the gas calibration temperature.

This configuration is also used in integrations that require a compact flow package at the installation point.



### Option: Remote Panel Display



Our Remote Display option offers the flexibility of using Alicat's display with units that are embedded inside processes or instrument enclosures.

The Remote Display retains all of the same features as our standard display.

The Remote Display is ideal for:

- OEMs Remote Panel Mounting
- Embedded Systems
- Gas Panels
- Fuel Cell Test Stations
- Leak Detection Systems
- Artificial Environments

## Accessory: BB9 Multi-Drop Box

The **BB9 Multi-Drop Box** makes it convenient to wire multiple flow and/or pressure devices to a single RS-232 or RS-485 port. **Now with an RS-232 to USB interface!**



The Multi-Drop Box has nine 8 pin Mini-DIN ports available. The ports are to be used with a standard double ended 8 pin Mini-DIN (DC-62) style cable going from the box to each flow or pressure device. (The BB9 can also be ordered with locking industrial connectors.)

A single DB9 D-SUB type connector (COM PORT) connects, using the included cable, to the serial connector on a PC or laptop.

All of the flow and/or pressure devices are powered via a terminal block on the front of the box.

If more than nine devices will be required, additional Multi-Drop Boxes can be daisy chained together with a double ended 8 pin Mini-DIN cable plugged into any receptacle on both boxes.

**BB9 Power Supply for Large Valve Controllers:** The PS24VHC (Power Supply 24Vdc High Current) is a 6.5Amp 24Vdc power supply designed for running multiple large controllers on a BB9.

The 6.5Amp power supply can run as many as 8 large valve controllers, which makes it ideal for the BB9 and multiple large valve (or small valve / large valve combination) controllers on a BB9.

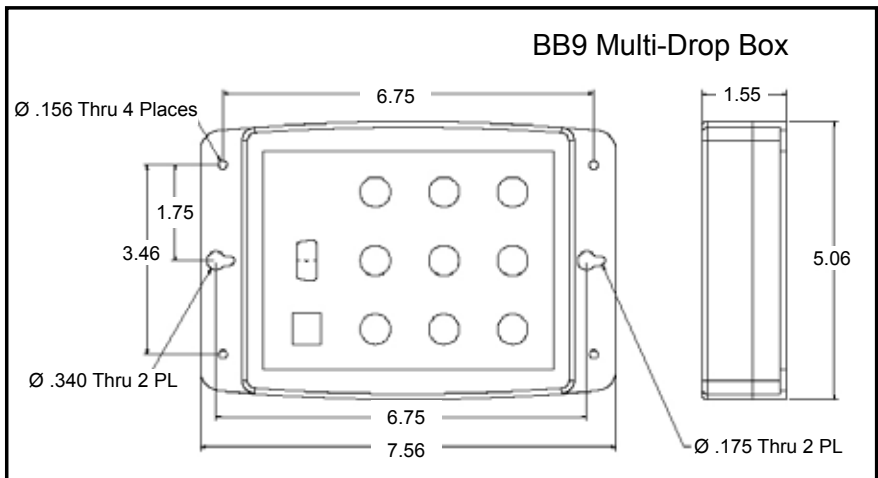

## Accessory: Flow Vision™ SC Software

**Flow Vision™ SC** is an intuitive software interface to help your test cycles run smoother and shorten your engineering time!

**Flow Vision™ SC** lets you connect to and communicate with multiple Alicat units simultaneously. Now you can view virtual displays, control tabs, charts and data lines from every connected Alicat device on the same screen.

**Flow Vision™ SC** supports all RS-232 and RS-485 Serial communication functions, including: **gas selection, taring, set-point control, valve tuning and flow averaging.**

**Session Saving:** Save and reload your configuration data with confidence.

**Script Building:** Create scripts to adjust a controller's set-point value at variable specified time intervals.

**Charting:** Chart as many parameters as you want off as many devices as you want, with color coding, zooming, and printing functionality.

**Alarms:** Create software alarms that will notify you of given parameter conditions.

**Data Capture & Logging:** Capture and log data to either a .csv file or a .txt file. Improved Data Logging and Data Log File Splitting for easy to manage data.

## Accessory: Flow Vision™ MX Software

**Alicat's New Flow Vision™ MX software gives you an easy way to do GAS BLENDING using Alicat Mass Flow Controllers and your own PC.**

**Flow Vision™ MX** software is a simple way to connect up to six Alicat mass flow controllers and create your own gas mix concentrations.

Using our inexpensive **BB9-232** and a single USB connection you can:

- **Create** your own gas blends
- **Adjust** flow rates
- **Save** your specific blend formulas.

All the controllers can be powered through the BB9-232 with a single power supply.

Just connect your unique gases to each controller, select the gas type either locally on the controller or through Flow Vision™ MX, manifold the flow outputs and create your gas mix.

## Accessories

Part Number	Description
FLOWVISIONSC	Flow Vision™ SC software for interface with all Alicat instruments
FLOWVISIONMX	Flow Vision™ MX software for gas blending
BB9-232	9 position Multi Drop Box with 9-pin serial port and USB to PC
BB9-I	9 position Multi-Drop Box, Industrial connectors
BB9-485	9 position Multi Drop Box with serial port only
BB9-I-485	9 position Multi-Drop Box, industrial connectors, serial port only
PVPS24U	Universal 100-240 VAC to 24 Volt DC Power Supply Adapter
PS24VHC	High current power supply for BB9 use with Large Valve Controllers
PVPS5USB	micro-USB to wall adapter
PCASE	Industrial carry and storage case for up to 2 portable meters/gauges
PCASE-L	Industrial carry and storage case for up to 6 meters and controllers
DC-61	8 Pin Male Mini-DIN connector cable, single ended, 6 foot length
DC-6RT	8 Pin Male Right Angle Mini-DIN Cable, single ended, 6 foot length
DC-251	8 Pin Male Mini-DIN connector cable, single ended, 25 foot length
DC-501	8 Pin Male Mini-DIN connector cable, single ended, 50 foot length
DC-751	8 Pin Male Mini-DIN connector cable, single ended, 75 foot length
DC-1001	8 Pin Male Mini-DIN connector cable, single ended, 100 foot length
DC-32RS	8-pin Male Mini-DIN connector cable, double ended, no analog, 3 foot length
DC-62RS	8-pin Male Mini-DIN connector cable, double ended, no analog, 6 foot length
DC-62	8 Pin Male Mini-DIN connector cable, double ended, 6 foot length
DC-252	8 Pin Male Mini-DIN connector cable, double ended, 25 foot length
DC-502	8 Pin Male Mini-DIN connector cable, double ended, 50 foot length
MD8DB9	8 Pin Male Mini-DIN to DB9 Female Adapter, 6 foot length
DBC-251	DB15 cable, single ended, 25 foot length
510199	DB9 cable, double-ended female, 3 meter length
IC10	Industrial cable, 6 Pin, single ended, 10 foot length
IC20	Industrial cable, 6 Pin, single ended, 20 foot length
IC50	Industrial cable, 6 Pin, single ended, 50 foot length
IC-102	Industrial cable, 6 pin double ended, 10 foot length
USB-RS232	RS-232 to USB Converter

## Accessories

MNPT to Compression Fittings	
10-32 - 1/8"	SS-200-1-0157
10-32 - 1/4"	SS-400-1-0256
1/8" - 1/8"	SS-200-1-2
1/8" - 1/4"	SS-400-1-2
1/8" - 3/8"	SS-600-1-2
1/8" - 1/2"	SS-810-1-2
1/8" - 3mm	SS-3M0-1-2
1/8" - 4mm	SS-4M0-1-2
1/8" - 6mm	SS-6M0-1-2
1/8" - 8mm	SS-8M0-1-2
1/8" - 12mm	SS-12M0-1-2
1/4" - 1/8"	SS-200-1-4
1/4" - 1/4"	SS-400-1-4
1/4" - 3/8"	SS-600-1-4
1/4" - 1/2"	SS-810-1-4
1/4" - 3mm	SS-3M0-1-4
1/4" - 4mm	SS-4M0-1-4
1/4" - 6mm	SS-6M0-1-4
1/4" - 8mm	SS-8M0-1-4
1/4" - 12mm	SS-12M0-1-4
1/2" - 1/8"	SS-200-1-8
1/2" - 1/4"	SS-400-1-8
1/2" - 3/8"	SS-600-1-8
1/2" - 1/2"	SS-810-1-8
1/2" - 3/4"	SS-1210-1-8
1/2" - 6mm	SS-6M0-1-8
1/2" - 8mm	SS-8M0-1-8
1/2" - 12mm	SS-12M0-1-8
1/2" - 16mm	SS-16M0-1-8
3/4" - 1/4"	SS-400-1-12
3/4" - 1/2"	SS-810-1-12
3/4" - 3/4"	SS-1210-1-12
3/4" - 12mm	SS-12M0-1-12
3/4" - 16mm	SS-16M0-1-12

Filters & Elements FNPT-MNPT	
10-32 5μ	510053
10-32 20μ	510054
1/8" 20μ	ILF-1/8-20
1/4" 40μ	ILF-1/4-40
1/2" 40μ	ILF-1/2-40*
3/4" 40μ	ILF-3/4-40*
20μ element	ILFE20
40μ element	ILFE40
40μ element	ILFE40L*

Filters & Elements FNPT-FNPT*	
10-32 5μ	CF-303-20-316
*requires MNPT to MNPT coupler to interface with Alicat flow bodies	

10-32 Male UNF to 1/8 FNPT Adapter	
410133	
Male M5 (10-32) Buna-N O-ring face seal to 1/8" Female NPT	

## Technical Data for P-Series Pressure Gauges

### Standard Specifications (Contact Alicat for available options.)

Performance	P-Series Gauges
Full scale pressure < 2" H2O Accuracy	Consult Factory
Full scale pressure ≥ 2" H2O Standard Accuracy	± 0.25%
Full scale pressure ≥ 2" H2O High Accuracy Option	± 0.125%
Repeatability	± 0.08% Full Scale
Zero Shift and Span Shift	0.02% Full Scale / °Celsius
Operating Range / Turndown Ratio	0.5% to 100% Full Scale / 200:1 Turndown
Excess Pressure	128% FS Measurable
Burst Pressure	3 X Full Scale
Typical Response Time <sup>1</sup>	5 ms (Adjustable)
Warm-up Time	< 1 Second

1. Volumes, feed pressures, exhaust pressures and line sizing will determine the limits of response times.

Operating Conditions	P-Series Gauges
Gas Compatibility	Compatible with all non-corrosive gases <sup>1</sup>
Operating Temperature	-10 to +50 °Celsius
Common Mode Pressure (Differential Pressure Units Only)	200 psig
Mounting Attitude Sensitivity	None
Ingress Protection	IP40
Wetted Materials	302 & 303 Stainless Steel, Viton®, Silicone RTV, Silicon, Glass. If your application demands a different material, please contact Alicat.

1. For aggressive gases, please see our PS-Series pressure Gauges. For use with water or other liquids please contact Alicat

Communication / Power	P-Series Gauges
Monochrome LCD or Color TFT Display with integrated touchpad	Displays Pressure
Digital Output Signal <sup>1</sup> Options	RS-232 Serial / RS-485 Serial / Modbus / PROFIBUS <sup>3</sup>
Analog Output Signal <sup>2</sup> Options	0-5 Vdc / 1-5 Vdc / 0-10 Vdc / 4-20 mA
Optional Secondary Analog Output Signal <sup>2</sup>	0-5 Vdc / 1-5 Vdc / 0-10 Vdc / 4-20 mA
Electrical Connection Options	8 Pin Mini-DIN / 9-pin D-sub (DB9) / 15-pin D-sub (DB15) / 6 pin locking
Supply Voltage	7-30 Vdc (15-30 Vdc for 4-20 mA outputs)
Supply Current	0.040 Amp

1. The **Digital Output Signal** communicates Pressure  
 2. The **Analog Output Signal** and **Optional Secondary Analog Output Signal** communicate Pressure  
 3. If selecting **PROFIBUS**, no analog signal is available. PROFIBUS units do not have the display. See PROFIBUS specifications for PROFIBUS supply voltages and currents. ([www.alicat.com/profibus](http://www.alicat.com/profibus))

### Mechanical Specifications

Pressure Product	Mechanical Dimensions	Process Connections <sup>1</sup>
P-Series Gauges	4.1"H x 2.4"W x 1.1"D	1/8" NPT Female

1. Compatible with Swagelok® tube, Parker®, face seal, push connect and compression adapter fittings. VCR and SAE connections upon request.

### Standard Available Ranges

P-Series Gauges		
-15 psig to 0 psig		
2 inH <sub>2</sub> O	2 inH <sub>2</sub> O	
1 psid	1 psig	
5 psid	5 psig	
15 psid	15 psig	15 psia
30 psid	30 psig	30 psia
100 psid	100 psig	100 psia
	500 psig	500 psia

Other ranges available. Please contact Alicat.

Select One Unit of Measure when Ordering		
PSIA	inHG	Atm
PSIG	inH <sub>2</sub> O	Torr
mmHG	mBar	kPa

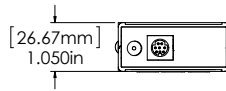

**P-Series:**  
All standard ranges

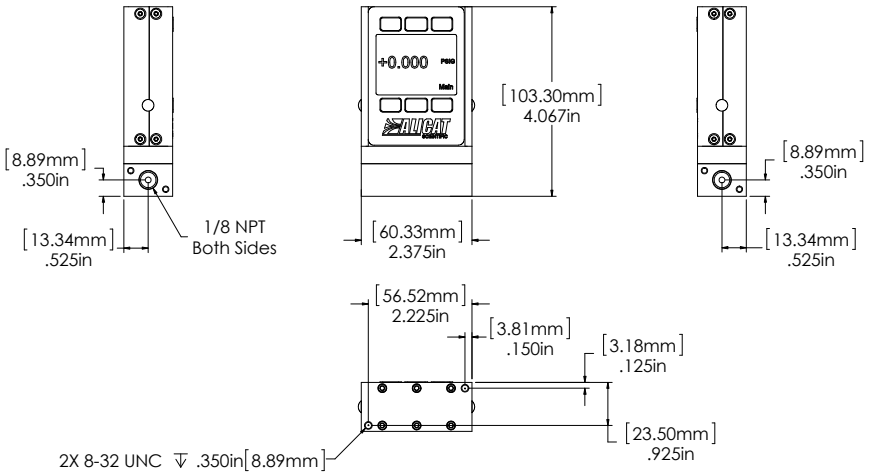

P Series approximate shipping weight: 1.0lb

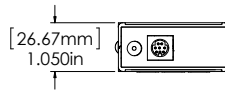

**P-Series:**  
Differential Pressure  
All standard ranges

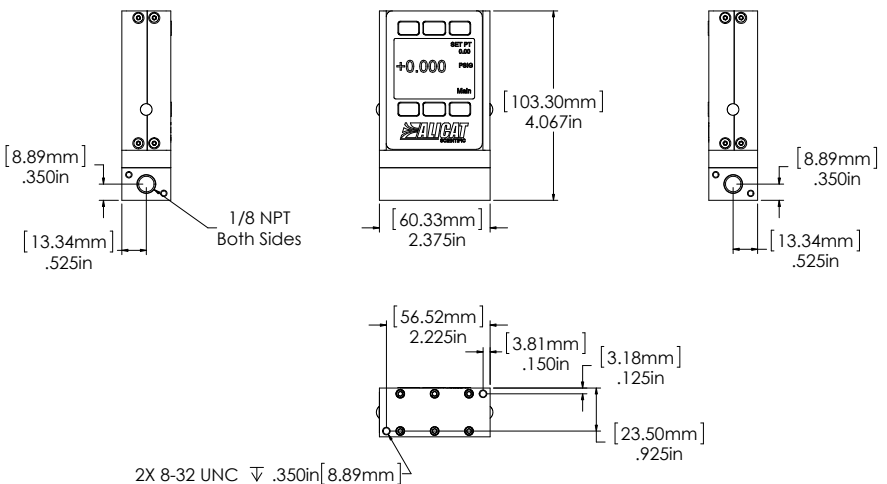

P Series approximate shipping weight: 1.0lb

## Technical Data for PC, PC3, PCR, and PCR3 Single Valve Pressure Controllers Standard Specifications (Contact Alicat for available options.)

Performance	PC & PC3 Controllers	PCR & PCR3 Controllers
Full scale pressure < 2" H2O Accuracy	Consult Factory	
Full scale pressure ≥ 2" H2O Standard Accuracy	± 0.25%	
Full scale pressure ≥ 2" H2O High Accuracy Option	± 0.125%	
Repeatability	± 0.08% Full Scale	
Zero Shift and Span Shift	0.02% Full Scale / °Celsius	
Operating Range / Turndown Ratio	0.5% to 100% Full Scale / 200:1 Turndown	
Excess Pressure	102.4% FS Controllable	
Burst Pressure	3 X Full Scale	
Typical Response Time <sup>1</sup>	100 ms (Adjustable)	
Warm-up Time	< 1 Second	
1. Volumes, feed pressures, exhaust pressures and line sizing will determine the limits of response times.		

Operating Conditions	PC & PC3 Controllers	PCR & PCR3 Controllers
Gas Compatibility	Compatible with all non-corrosive gases <sup>1</sup>	
Operating Temperature	-10 to +50 °Celsius	
Common Mode Pressure (Differential Pressure Units Only)	150 psig	
Mounting Attitude Sensitivity	None	
Valve Type	Normally Closed	
Ingress Protection	IP40	
Wetted Materials	400 Stainless Steel, 302 & 303 Stainless Steel, Viton®, Silicone RTV, Silicon, Glass. <b>PC &amp; PC3 Only Add:</b> Brass If your application demands a different material, please contact Alicat.	
1. For aggressive gases, please see our PCS and PCRS-Series pressure controllers. For use with water or other liquids please contact Alicat		

Communication / Power	PC & PC3 Controllers	PCR & PCR3 Controllers
Monochrome LCD or Color TFT Display with integrated touchpad	Displays Pressure	
Digital Output Signal <sup>1</sup> Options	RS-232 Serial / RS-485 Serial / Modbus / PROFIBUS <sup>3</sup>	
Analog Output Signal <sup>2</sup> Options	0-5 Vdc / 1-5 Vdc / 0-10 Vdc / 4-20 mA	
Optional Secondary Analog Output Signal <sup>2</sup>	0-5 Vdc / 1-5 Vdc / 0-10 Vdc / 4-20 mA	
Electrical Connection Options	8 Pin Mini-DIN / 9-pin D-sub (DB9) / 15-pin D-sub (DB15) / 6 pin locking	
Supply Voltage	12-30 Vdc (15-30 Vdc for 4-20 mA outputs)	24-30 Vdc
Supply Current	0.250 Amp	0.750 Amp
1. The <b>Digital Output Signal</b> communicates Pressure 2. The <b>Analog Output Signal</b> and <b>Optional Secondary Analog Output Signal</b> communicate Pressure 3. If selecting <b>PROFIBUS</b> , no analog signal is available. PROFIBUS units do not have the display. See PROFIBUS specifications for PROFIBUS supply voltages and currents. ( <a href="http://www.alicat.com/profibus">www.alicat.com/profibus</a> )		

### Mechanical Specifications

Pressure Product	Mechanical Dimensions	Process Connections <sup>1</sup>
PC & PC3 Controllers	4.1"H x 3.6"W x 1.1"D	1/8" NPT Female
PCR & PCR3 Controllers	5.5"H x 2.9"W x 5.5"D	3/4" NPT Female
1. Compatible with Swagelok® tube, Parker®, face seal, push connect and compression adapter fittings. VCR and SAE connections upon request.		

### Standard Available Ranges

PC, PC3, PCR & PCR3 Controllers		
-15 psig to 0 psig		
2 inH <sub>2</sub> O <sub>D</sub>	2 inH <sub>2</sub> O <sub>G</sub>	
1 psid	1 psig	
5 psid	5 psig	
15 psid	15 psig	15 psia
30 psid	30 psig	30 psia
100 psid	100 psig	100 psia
	500 psig	500 psia
Other ranges available. Please contact Alicat.		

Select One Unit of Measure when Ordering		
PSIA	inHG	Atm
PSIG	inH <sub>2</sub> O	Torr
mmHG	mBar	kPa



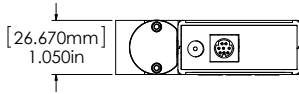

**PC-Series:**  
All standard ranges

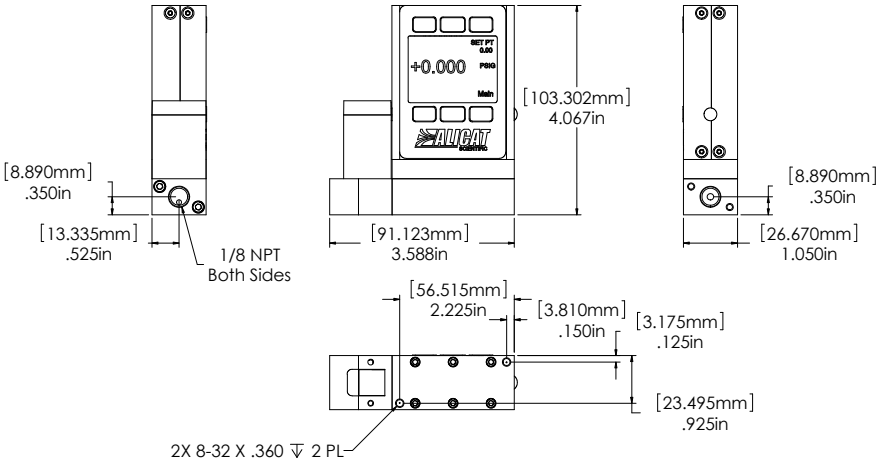

100 sccm to 20 slpm approximate weight: 1.2lb

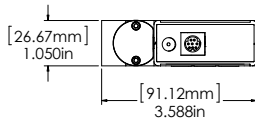

**PC-Series:**  
Differential Pressure  
All standard ranges

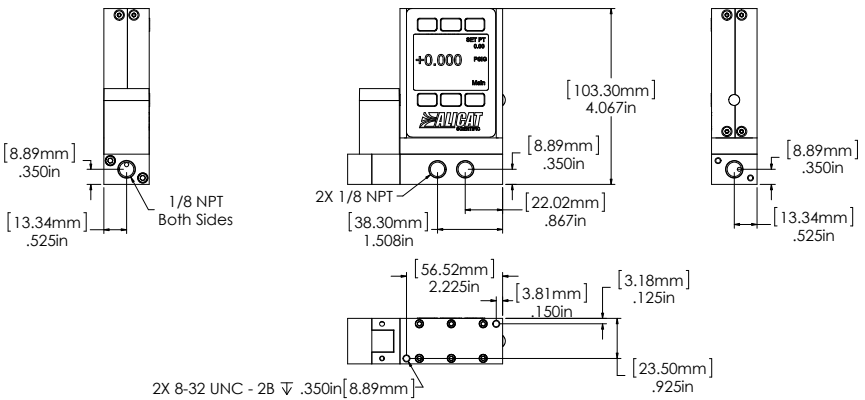

100 sccm to 20 slpm approximate weight: 1.2lb

**PC3-Series:**  
All standard ranges

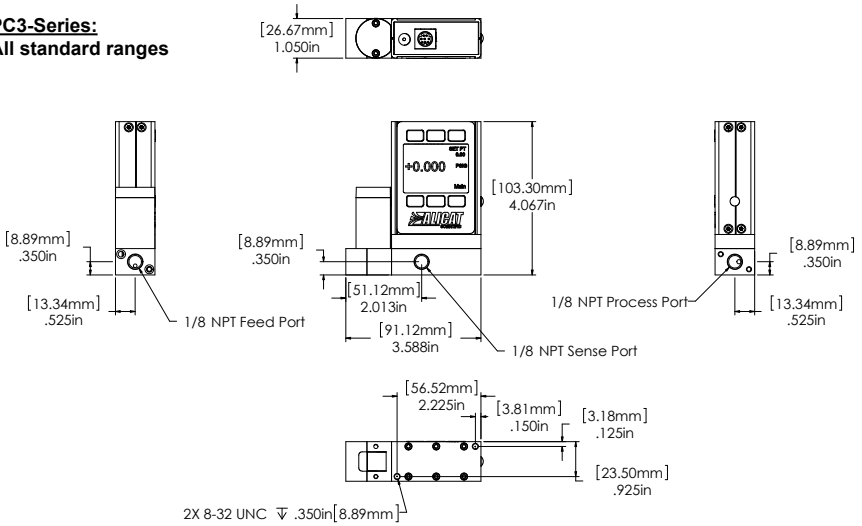

100 sccm to 20 slpm approximate weight: 1.2lb

**PCR3-Series:**  
All standard ranges

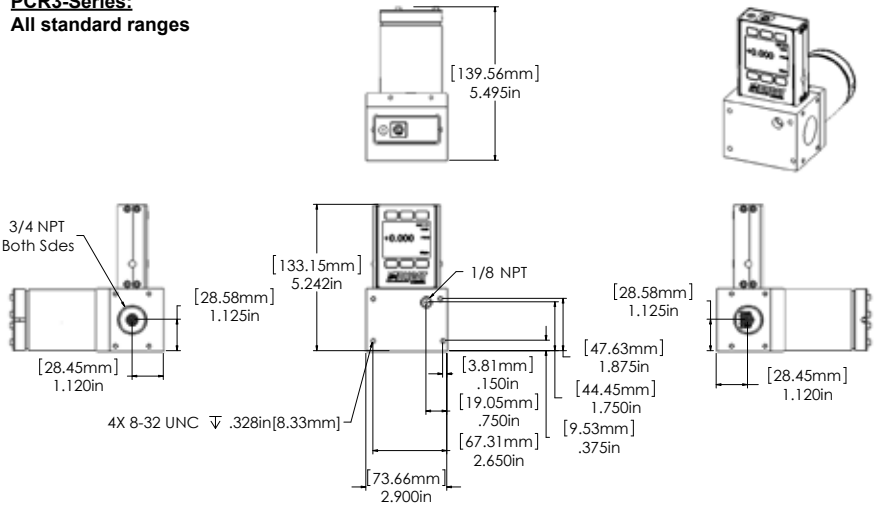

PCR3 approximate weight: 9.0 lb.

**PCR-Series:**  
**Most standard ranges**

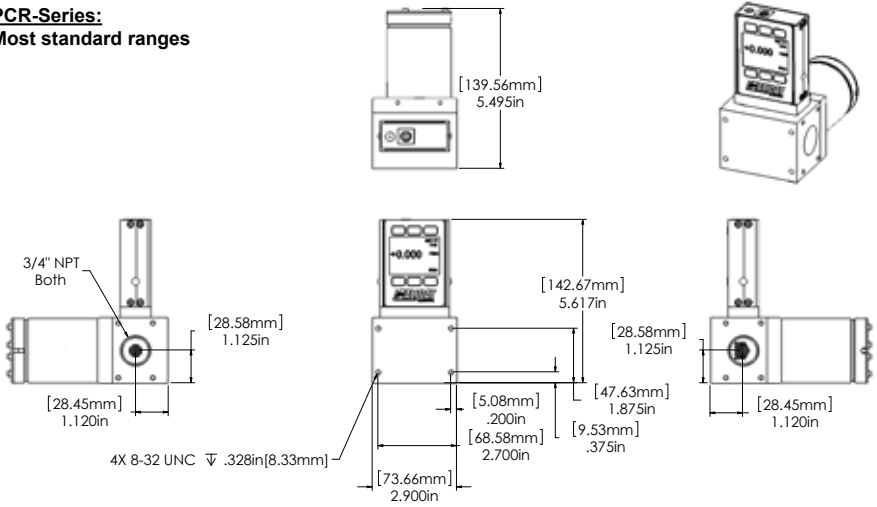

PCR approximate weight: 9.0 lb.

**PCR-Series:**  
**Differential Pressure 5 inH2O**

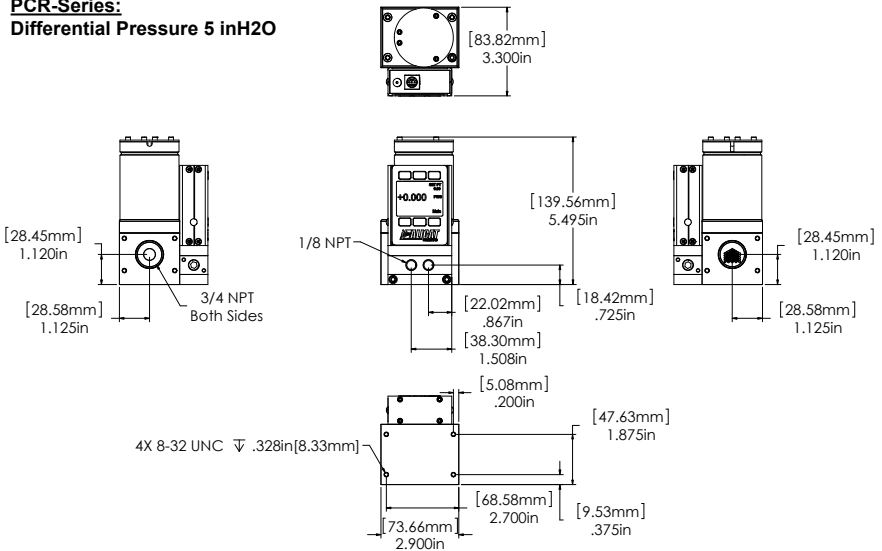

PCR approximate weight: 9.0 lb.

## Technical Data for PCD, PCD3, PCRD & PCRD3 Dual Valve Pressure Controllers

### Standard Specifications (Contact Alicat for available options.)

Performance	PCD & PCD3 Controllers	PCRD & PCRD3 Controllers
Full scale pressure < 2" H2O Accuracy	Consult Factory	
Full scale pressure ≥ 2" H2O Standard Accuracy	± 0.25%	
Full scale pressure ≥ 2" H2O High Accuracy Option	± 0.125%	
Repeatability	± 0.08% Full Scale	
Zero Shift and Span Shift	0.02% Full Scale / °Celsius	
Operating Range / Turndown Ratio	0.5% to 100% Full Scale / 200:1 Turndown	
Excess Pressure	102.4% FS Controllable	
Burst Pressure	3 X Full Scale	
Typical Response Time <sup>1</sup>	100 ms (Adjustable)	
Warm-up Time	< 1 Second	

1. Volumes, feed pressures, exhaust pressures and line sizing will determine the limits of response times.

Operating Conditions	PCD & PCD3 Controllers	PCRD & PCRD3 Controllers
Gas Compatibility	Compatible with all non-corrosive gases <sup>1</sup>	
Operating Temperature	-10 to +50 °Celsius	
Common Mode Pressure (Differential Pressure Units Only)	150 psig	
Mounting Attitude Sensitivity	None	Mount with valve cylinder vertical & upright
Valve Type	Normally Closed	
Ingress Protection	IP40	
Wetted Materials	302 & 303 Stainless Steel, Viton®, Silicone RTV, Brass, 400 Series Stainless Steel, Silicon, Glass. If your application demands a different material, please contact Alicat.	

1. For aggressive gases, please see our PCS and PCRS-Series pressure controllers. For use with water or other liquids please contact Alicat

Communication / Power	PCD & PCD3 Controllers	PCRD & PCRD3 Controllers
Monochrome LCD or Color TFT Display with integrated touchpad	Displays Pressure	
Digital Output Signal <sup>1</sup> Options	RS-232 Serial / RS-485 Serial / Modbus / PROFIBUS <sup>3</sup>	
Analog Output Signal <sup>2</sup> Options	0-5 Vdc / 1-5 Vdc / 0-10 Vdc / 4-20 mA	
Optional Secondary Analog Output Signal <sup>2</sup>	0-5 Vdc / 1-5 Vdc / 0-10 Vdc / 4-20 mA	
Electrical Connection Options	8 Pin Mini-DIN / 9-pin D-sub (DB9) / 15-pin D-sub (DB15) / 6 pin locking	
Supply Voltage	12-30 Vdc (15-30 Vdc for 4-20 mA outputs)	24-30 Vdc
Supply Current	0.250 Amp	0.750 Amp

1. The **Digital Output Signal** communicates Pressure  
 2. The **Analog Output Signal** and **Optional Secondary Analog Output Signal** communicate Pressure  
 3. If selecting **PROFIBUS**, no analog signal is available. PROFIBUS units do not have the display. See PROFIBUS specifications for PROFIBUS supply voltages and currents. ([www.alicat.com/profibus](http://www.alicat.com/profibus))

### Mechanical Specifications

Dual Valve Pressure Controllers	Mechanical Dimensions	Process Connections <sup>1</sup>
PCD & PCD3 All Standard Ranges	4.1"H x 4.8"W x 1.1"D	1/8" NPT Female
PCRD & PCRD3 All Standard Ranges	5.5"H x 10.6"W x 2.3"D	3/4" NPT Female

1. Compatible with Swagelok® tube, Parker®, face seal, push connect and compression adapter fittings. VCR and SAE connections upon request.

### Standard Available Ranges

PCD, PCD3, PCRD, and PCRD3 Controllers		
-15 psig to 0 psig		
2 inH <sub>2</sub> OD	2 inH <sub>2</sub> OG	
1 psid	1 psig	
5 psid	5 psig	
15 psid	15 psig	15 psia
30 psid	30 psig	30 psia
100 psid	100 psig	100 psia
	500 psig	500 psia

Other ranges available. Please contact Alicat.

Select One Unit of Measure when Ordering		
PSIA	inHG	Atm
PSIG	inH <sub>2</sub> O	Torr
mmHG	mBar	kPa

**PCD-Series:**  
All standard ranges

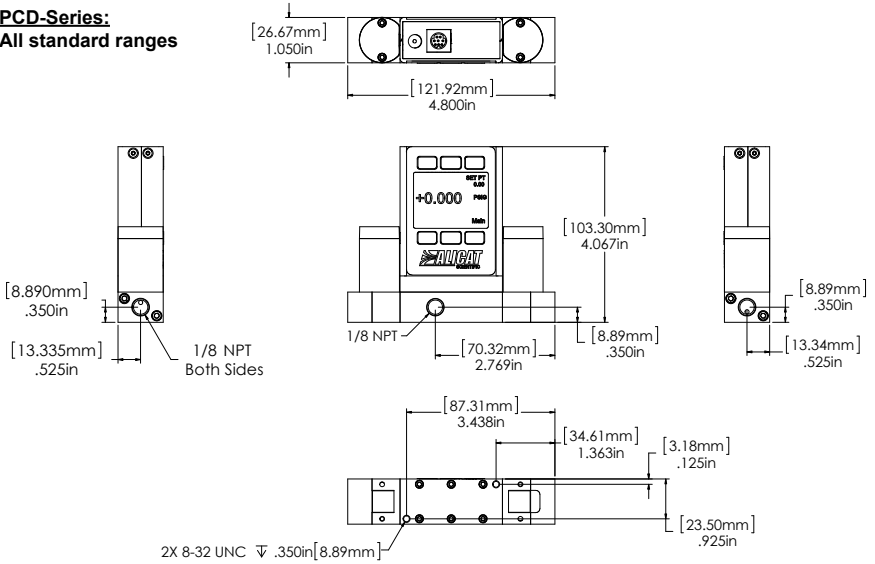

**PCD-Series:**  
Differential Pressure  
All standard ranges

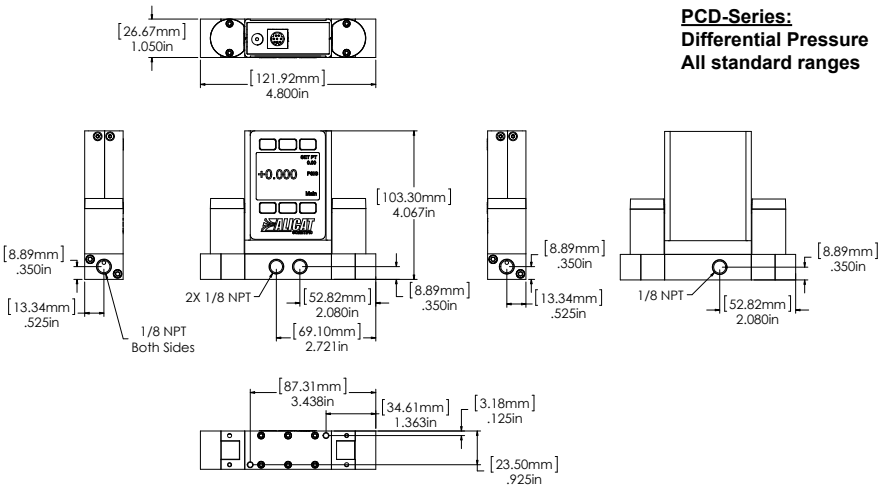

**PCRD-Series:**  
All standard ranges

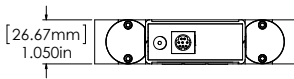
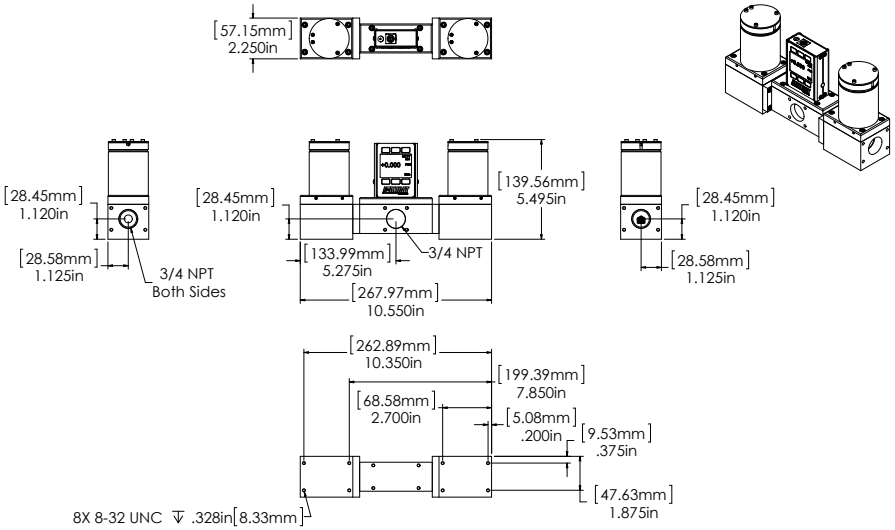

**PCD3  
100PSIG**

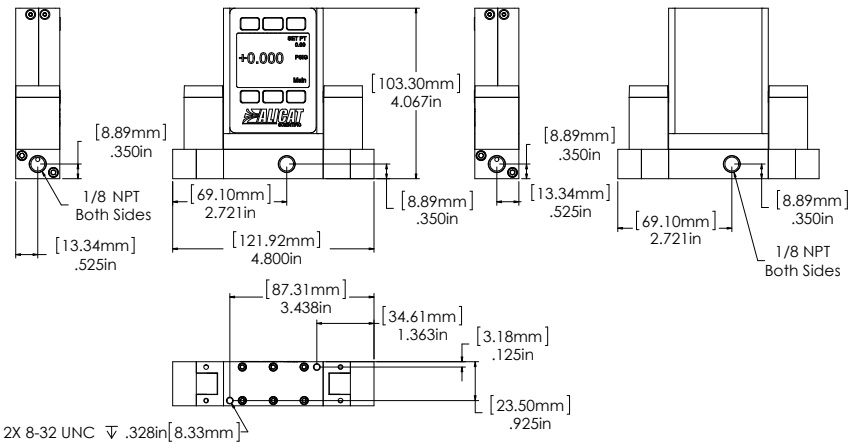

**PCD3  
500PSIA**

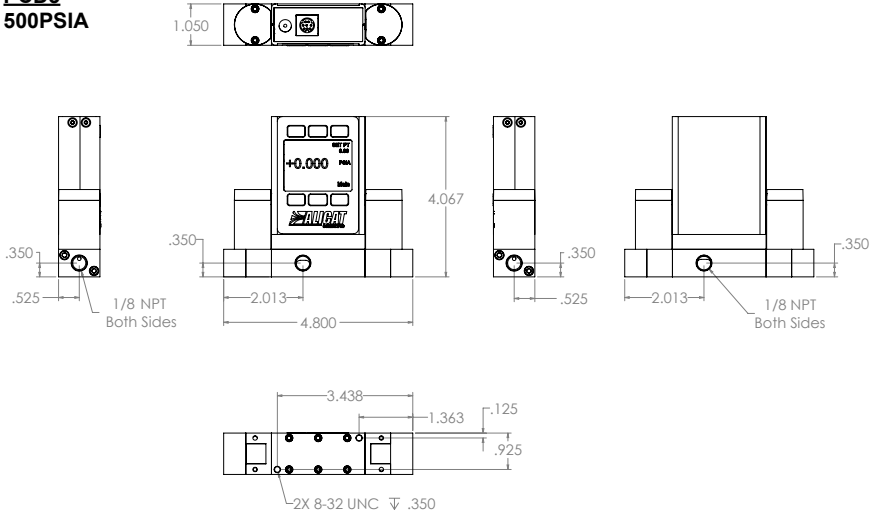

**PCRD3  
15PSIG**

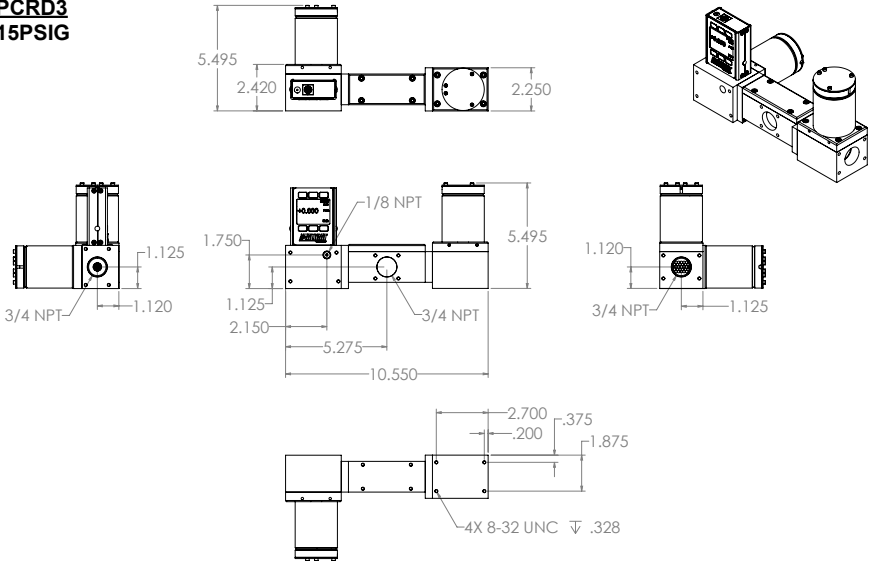

## **Technical Data for Alicat PS Series Pressure and Vacuum Gauges**

Alicat PS instruments are built for use with aggressive gases. For the most part these instruments maintain the specifications of equivalently ranged P-Series devices.

In addition to all non-corrosive gases, PS Gauges are configured to operate with the following aggressive gases.

### **PS Gauge Aggressive Gas Compatibility List :**

NO	Nitric Oxide to 100%
NF3	Nitrogen Trifluoride to 100%
NH3	Ammonia to 100%
NO2	Nitrogen Dioxide to 100%
Cl2	Chlorine to 100%
H2S	Hydrogen Sulfide to 100%
SO2	Sulfur Dioxide to 100%
Propylene to 100%	

In addition the following gases are available upon request:

Refrigerant gases to 100% (refrigerant gases may require custom seals, consult Alicat)

If your application requires another gas or gas mixture, please contact Alicat. We will do our best to accommodate your request.

## **Technical Data for PCS, PCRS, PCDS and PCRDS Pressure and Vacuum Controllers**

Alicat PCS, PCRS, PCDS and PCRDS instruments are built for use with aggressive gases. For the most part these instruments maintain the specifications of equivalently ranged PC, PCR, PCD and PCRDS Series devices.

In addition to all non-corrosive gases, PCS, PCRS, PCDS and PCRDS controllers are configured to operate with the following aggressive gases.

### **PCS, PCRS, PCDS and PCRDS Controller Aggressive Gas Compatibility List :**

NO	Nitric Oxide to 100%
NF3	Nitrogen Trifluoride to 100%
NH3	Ammonia to 100%
NO2	Nitrogen Dioxide to 100%
H2S	Hydrogen Sulfide to 100% (22°C and under)
Propylene to 100%	

In addition, the following gases are available upon request:

Refrigerant gases to 100% (refrigerant gases may require custom seals, consult Alicat)

Other gases to 1000 ppm in an inert carrier

SO2 and Cl2: must be ordered with a specialized valve.

If your application requires another gas or gas mixture, please contact Alicat. We will do our best to accommodate your request.

## **USING PS, PCS, and PCRS INSTRUMENTS with FLUIDS**

PS, PCS and PCRS devices may be used with chemically compatible liquids. Please contact Alicat for technical assistance if your application involves fluids.



## Technical Data for PS-Series Pressure Gauges

### Standard Specifications (Contact Alicat for available options.)

Performance	PS-Series Gauges
Full scale pressure Standard Accuracy	± 0.25%
Full scale pressure High Accuracy Option	± 0.125%
Repeatability	± 0.08% Full Scale
Zero Shift and Span Shift	0.02% Full Scale / °Celsius
Operating Range / Turndown Ratio	0.5% to 100% Full Scale / 200:1 Turndown
Excess Pressure	128% FS Measurable
Burst Pressure	3 X Full Scale
Typical Response Time <sup>1</sup>	5 ms (Adjustable)
Warm-up Time	< 1 Second
1. Volumes, feed pressures, exhaust pressures and line sizing will determine the limits of response times.	

Operating Conditions	PS-Series Gauges
Gas Compatibility	Compatible with all non-corrosive gases and select aggressive gases <sup>1</sup>
Operating Temperature	-10 to +50 °Celsius
Common Mode Pressure (Differential Pressure Units Only)	200 psig
Mounting Attitude Sensitivity	None
Ingress Protection	IP40
Wetted Materials	316LSS, FFKM (Kalrez) standard; Viton, EPDM, Buna, Neoprene as needed for some gases. If your application demands a different material, please contact Alicat.
1. In addition to all non-corrosive gases, PS Gauges are configured to operate with the following aggressive gases: Ammonia, Chlorine, Hydrogen Sulfide, Nitric Oxide, Nitrogen Dioxide, Nitrogen Trifluoride, Propylene, Sulfur Dioxide. The following gases are available upon request: Refrigerant gases to 100% (Refrigerant gases may require custom seals, consult Alicat.) If your application requires another gas or gas mixture, please contact Alicat. For use with water or other liquids please contact Alicat.	

Communication / Power	PS-Series Gauges
Monochrome LCD or Color TFT Display with integrated touchpad	Displays Pressure
Digital Output Signal <sup>1</sup> Options	RS-232 Serial / RS-485 Serial / Modbus / PROFIBUS <sup>3</sup>
Analog Output Signal <sup>2</sup> Options	0-5 Vdc / 1-5 Vdc / 0-10 Vdc / 4-20 mA
Optional Secondary Analog Output Signal <sup>2</sup>	0-5 Vdc / 1-5 Vdc / 0-10 Vdc / 4-20 mA
Electrical Connection Options	8 Pin Mini-DIN / 9-pin D-sub (DB9) / 15-pin D-sub (DB15) / 6 pin locking
Supply Voltage	7-30 Vdc (15-30 Vdc for 4-20 mA outputs)
Supply Current	0.040 Amp
1. The <b>Digital Output Signal</b> communicates Pressure	
2. The <b>Analog Output Signal</b> and <b>Optional Secondary Analog Output Signal</b> communicate Pressure	
3. If selecting <b>PROFIBUS</b> , no analog signal is available. PROFIBUS units do not have the display. See PROFIBUS specifications for PROFIBUS supply voltages and currents. ( <a href="http://www.alicat.com/profibus">www.alicat.com/profibus</a> )	

### Mechanical Specifications

Pressure Product	Mechanical Dimensions	Process Connections <sup>1</sup>
PS Gauges	4.1"H x 2.4"W x 1.1"D	1/8" NPT Female
1. Compatible with Swagelok® tube, Parker®, face seal, push connect and compression adapter fittings. VCR and SAE connections upon request.		

### Standard Available Ranges

PS-Series Gauges		
-15 psig to 0 psig		
1 psid	1 psig	
5 psid	5 psig	
15 psid	15 psig	15 psia
30 psid	30 psig	30 psia
100 psid	100 psig	100 psia
	500 psig	500 psia
Other ranges available. Please contact Alicat.		

Select One Unit of Measure when Ordering		
PSIA	inHG	Atm
PSIG	inH <sub>2</sub> O	Torr
mmHG	mBar	kPa

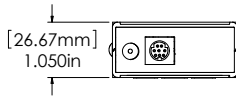

**PS-Series:**  
All standard ranges  
to 500 psig

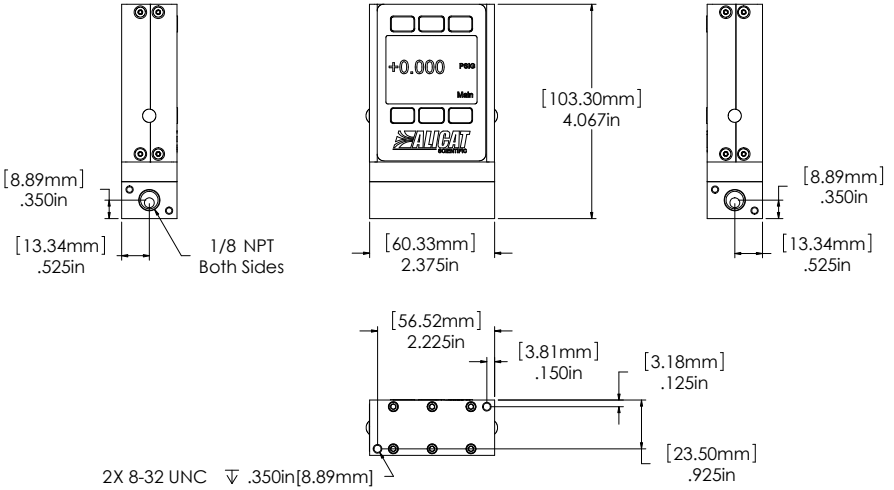

## Technical Data for PCS and PCRS Single Valve Pressure Controllers Standard Specifications (Contact Alicat for available options.)

Performance	PCS Controllers	PCRS Controllers
Full scale pressure Standard Accuracy	± 0.25%	
Full scale pressure High Accuracy Option	± 0.125%	
Repeatability	± 0.08% Full Scale	
Zero Shift and Span Shift	0.02% Full Scale / °Celsius	
Operating Range / Turndown Ratio	0.5% to 100% Full Scale / 200:1 Turndown	
Excess Pressure	102.4% FS Controllable	
Burst Pressure	3 X Full Scale	
Typical Response Time <sup>1</sup>	100 ms (Adjustable)	
Warm-up Time	< 1 Second	
1. Volumes, feed pressures, exhaust pressures and line sizing will determine the limits of response times.		

Operating Conditions	PCS Controllers	PCRS Controllers
Gas Compatibility	Compatible with all non-corrosive gases and select aggressive gases <sup>1</sup>	
Operating Temperature	-10 to +50 °Celsius	
Common Mode Pressure (Differential Pressure Units Only)	150 psig	
Mounting Attitude Sensitivity	None	
Valve Type	Normally Closed	
Ingress Protection	IP40	
Wetted Materials	303SS, 430FRSS, 316LSS, FFKM (Kalrez) standard; Viton, EPDM, Buna, Neoprene as needed for some gases. If your application demands a different material, please contact Alicat.	

1. In addition to all non-corrosive gases, PCS & PCRS controllers are configured to operate with the following aggressive gases: Ammonia, Hydrogen Sulfide, Nitric Oxide, Nitrogen Dioxide, Nitrogen Trifluoride, Propylene. The following gases are available upon request: Refrigerant gases to 100% (Refrigerant gases may require custom seals, consult Alicat.) Other gases to 1000 ppm in an inert carrier. If your application requires another gas or gas mixture, please contact Alicat. PCS and PCRS devices may be used with chemically compatible liquids. Please contact Alicat for technical assistance if your application involves fluids.

Communication / Power	PCS Controllers	PCRS Controllers
Monochrome LCD or Color TFT Display with integrated touchpad	Displays Pressure	
Digital Output Signal <sup>1</sup> Options	RS-232 Serial / RS-485 Serial / Modbus / PROFIBUS <sup>3</sup>	
Analog Output Signal <sup>2</sup> Options	0-5 Vdc / 1-5 Vdc / 0-10 Vdc / 4-20 mA	
Optional Secondary Analog Output Signal <sup>2</sup>	0-5 Vdc / 1-5 Vdc / 0-10 Vdc / 4-20 mA	
Electrical Connection Options	8 Pin Mini-DIN / 9-pin D-sub (DB9) / 15-pin D-sub (DB15) / 6 pin locking	
Supply Voltage	12-30 Vdc (15-30 Vdc for 4-20 mA outputs)	24-30 Vdc
Supply Current	0.250 Amp	0.750 Amp

- The **Digital Output Signal** communicates Pressure
- The **Analog Output Signal** and **Optional Secondary Analog Output Signal** communicate Pressure
- If selecting **PROFIBUS**, no analog signal is available. PROFIBUS units do not have the display. See PROFIBUS specifications for PROFIBUS supply voltages and currents. ([www.alicat.com/profibus](http://www.alicat.com/profibus))

### Mechanical Specifications

Pressure Product	Mechanical Dimensions	Process Connections <sup>1</sup>
PCS Controllers	4.1"H x 3.6"W x 1.1"D	1/8" NPT Female
PCRS Controllers	5.7"H x 2.9"W x 5.5"D	3/4" NPT Female

1. Compatible with Beswick®, Swagelok® tube, Parker®, face seal, push connect and compression adapter fittings. VCR and SAE connections upon request.

### Standard Available Ranges

PCS & PCRS Controllers		
-15 psig to 0 psig		
1 psid	1 psig	
5 psid	5 psig	
15 psid	15 psig	15 psia
30 psid	30 psig	30 psia
100 psid	100 psig	100 psia
	500 psig	500 psia
Other ranges available. Please contact Alicat.		

Select One Unit of Measure when Ordering		
PSIA	inHG	Atm
PSIG	inH <sub>2</sub> O	Torr
mmHG	mBar	kPa

**PCS-Series:**  
All standard ranges  
to 500 psig

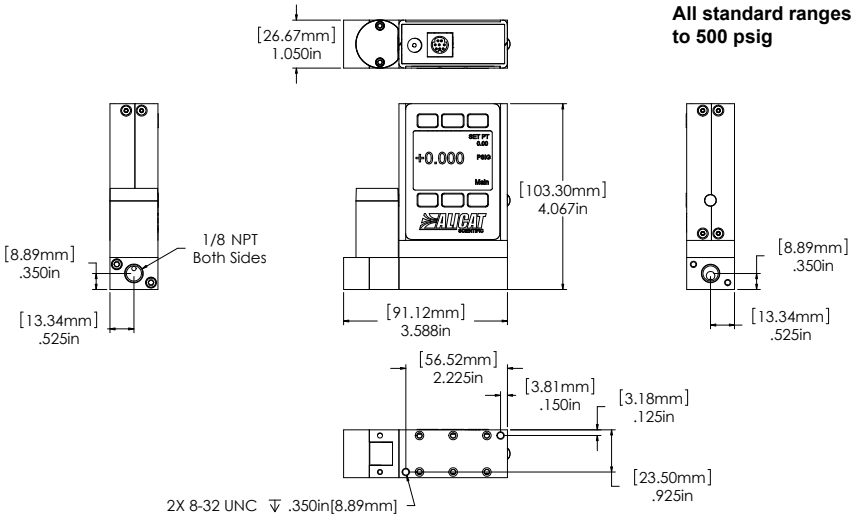

**PCRS-Series:**  
Most standard ranges

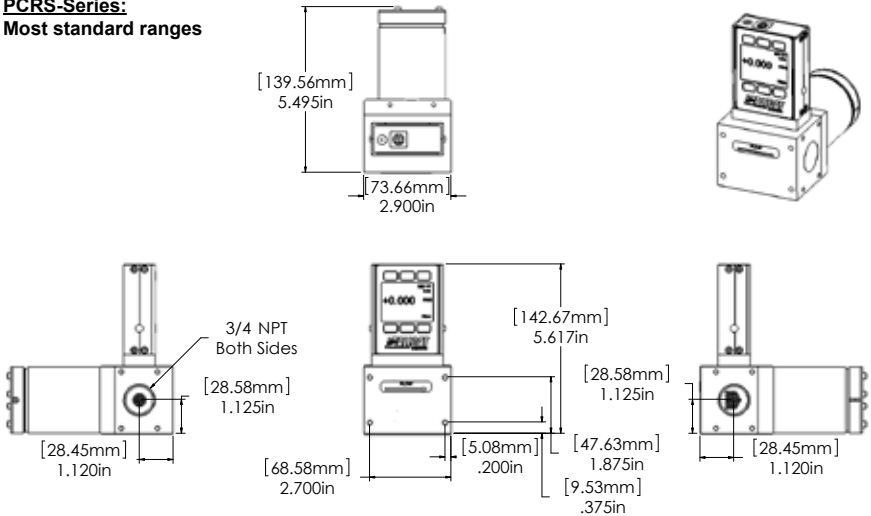

## Technical Data for PCDS & PCDRS Dual Valve Pressure Controllers Standard Specifications (Contact Alicat for available options.)

Performance	PCDS Controllers	PCDRS Controllers
Full scale pressure Standard Accuracy	± 0.25%	
Full scale pressure High Accuracy Option	± 0.125%	
Repeatability	± 0.08% Full Scale	
Zero Shift and Span Shift	0.02% Full Scale / °Celsius	
Operating Range / Turndown Ratio	0.5% to 100% Full Scale / 200:1 Turndown	
Excess Pressure	102.4% FS Controllable	
Burst Pressure	3 X Full Scale	
Typical Response Time <sup>1</sup>	100 ms (Adjustable)	
Warm-up Time	< 1 Second	
1. Volumes, feed pressures, exhaust pressures and line sizing will determine the limits of response times.		

Operating Conditions	PCDS Controllers	PCDRS Controllers
Gas Compatibility	Compatible with all non-corrosive gases <sup>1</sup>	
Operating Temperature	-10 to +50 °Celsius	
Common Mode Pressure (Differential Pressure Units Only)	150 psig	
Mounting Attitude Sensitivity	None	Mount with valve cylinder vertical & upright
Valve Type	Normally Closed	
Ingress Protection	IP40	
Wetted Materials	316LSS, 303SS, 430FRSS, FFKM (Kalrez) standard; Viton, EPDM, Buna, Neoprene as needed for some gases. If your application demands a different material, please contact Alicat.	

1. In addition to all non-corrosive gases, PCDS & PCDRS controllers are configured to operate with the following aggressive gases: Ammonia, Hydrogen Sulfide, Nitric Oxide, Nitrogen Dioxide, Nitrogen Trifluoride, Propylene. The following gases are available upon request: Refrigerant gases to 100% (Refrigerant gases my require custom seals, consult Alicat.) Other gases to 1000 ppm in an inert carrier. If your application requires another gas or gas mixture, please contact Alicat. PCS and PCRS devices may be used with chemically compatible liquids. Please contact Alicat for technical assistance if your application involves fluids.

Communication / Power	PCDS Controllers	PCDRS Controllers
Monochrome LCD or Color TFT Display with integrated touchpad	Displays Pressure	
Digital Output Signal <sup>1</sup> Options	RS-232 Serial / RS-485 Serial / Modbus / PROFIBUS <sup>3</sup>	
Analog Output Signal <sup>2</sup> Options	0-5 Vdc / 1-5 Vdc / 0-10 Vdc / 4-20 mA	
Optional Secondary Analog Output Signal <sup>2</sup>	0-5 Vdc / 1-5 Vdc / 0-10 Vdc / 4-20 mA	
Electrical Connection Options	8 Pin Mini-DIN / 9-pin D-sub (DB9) / 15-pin D-sub (DB15) / 6 pin locking	
Supply Voltage	12-30 Vdc (15-30 Vdc for 4-20 mA outputs)	24-30 Vdc
Supply Current	0.250 Amp	0.750 Amp
1. The <b>Digital Output Signal</b> communicates Pressure 2. The <b>Analog Output Signal</b> and <b>Optional Secondary Analog Output Signal</b> communicate Pressure 3. If selecting <b>PROFIBUS</b> , no analog signal is available. PROFIBUS units do not have the display. See PROFIBUS specifications for PROFIBUS supply voltages and currents. ( <a href="http://www.alicat.com/profibus">www.alicat.com/profibus</a> )		

### Mechanical Specifications

Dual Valve Pressure Controllers	Mechanical Dimensions	Process Connections <sup>1</sup>
PCDS All Standard Ranges	4.1"H x 4.8"W x 1.1"D	1/8" NPT Female
PCRD All Standard Ranges	5.5"H x 10.6"W x 2.3"D	3/4" NPT Female

1. Compatible with Swagelok® tube, Parker®, face seal, push connect and compression adapter fittings. VCR and SAE connections upon request.

### Standard Available Ranges

PCDS and PCDRS Controllers		
-15 psig to 0 psig		
1 psid	1 psig	
5 psid	5 psig	
15 psid	15 psig	15 psia
30 psid	30 psig	30 psia
100 psid	100 psig	100 psia
	500 psig	500 psia
Other ranges available. Please contact Alicat.		

Select One Unit of Measure when Ordering		
PSIA	inHG	Atm
PSIG	inH <sub>2</sub> O	Torr
mmHG	mBar	kPa

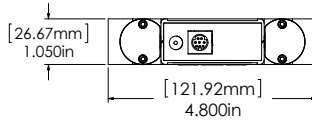

**PCDS-Series:**  
**Most standard ranges**

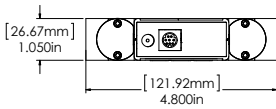
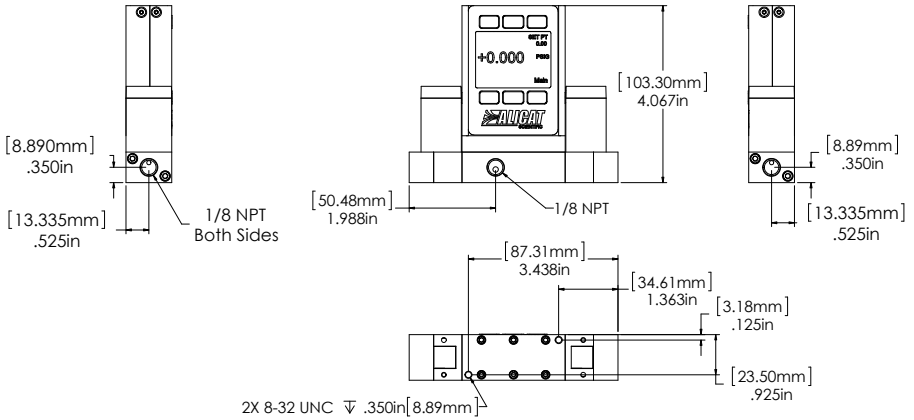

**PCDS-Series:**  
**Differential Pressure**  
**Most standard ranges**

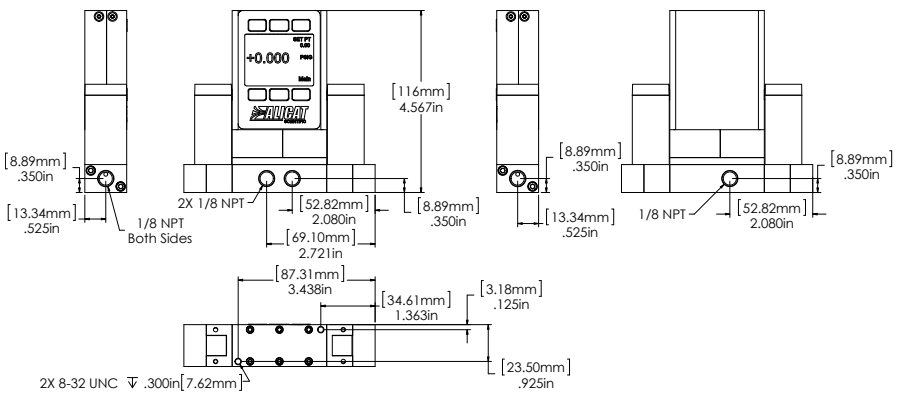

**PCDRS-Series:**  
**Most standard ranges**

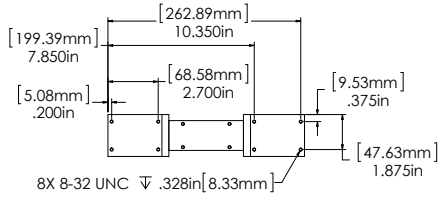
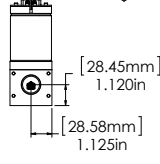
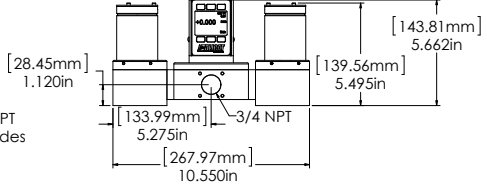
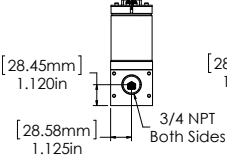
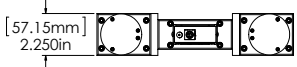
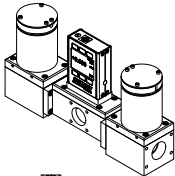

## Technical Data for PROFIBUS Meters, Gauges and Controllers

**NOTICE:** The following specifications are applicable to Alicat PROFIBUS enabled meters, gauges and controllers only.

All other operating specifications are shown in the Technical Data page for standard Alicat instruments.

All standard device features and functions are available and operate in accordance with the standard Alicat Scientific device operating manual provided with the device.

Specification	Meter or Gauge	Small Valve Controller	Large Valve Controller	Description
Input /Output Signal Digital				PROFIBUS DP
Electrical Connections	DB9			
Supply Voltage:	7 to 30 Vdc	12 to 30 Vdc	24 to 30 Vdc	
Supply Current	80mA @ 12Vdc 65mA @ 24Vdc	295mA @ 12Vdc 280mA @ 24Vdc	780mA @ 24Vdc	

### Power and Signal Connections:

Connect to the device using two DB9 connectors.

The female top connection is PROFIBUS.

The male connection on the side is power and RS-232 or RS-485.

Pin out diagrams for all PROFIBUS enabled Alicat devices are shown:

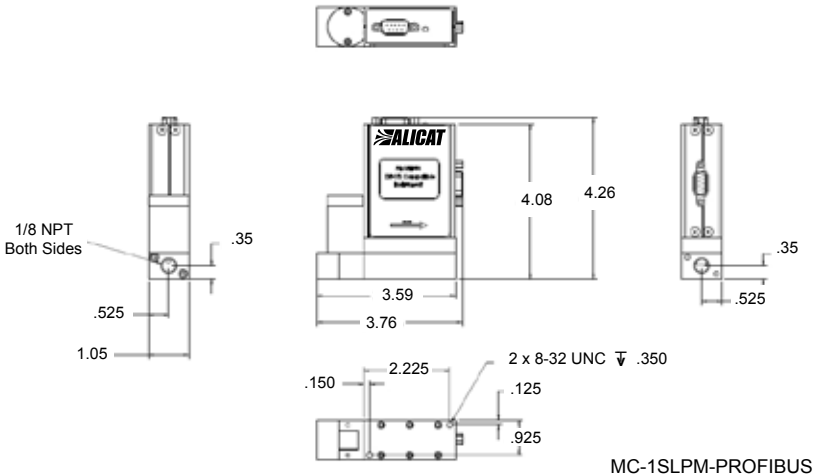
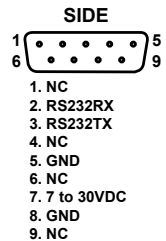
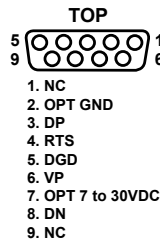

PROFIBUS MC1SLPM shown to provide PROFIBUS connector dimensions only. Flow body and valve dimensions will vary with range. Please see Alicat's device specifications for complete dimensions.

PROFIBUS units do not have a display screen.



## Eight Pin Mini-DIN Connector Pin-Outs

If your Alicat Instrument was ordered with the standard Eight Pin Mini-DIN connection, please be sure to reference the following pin-out diagram.

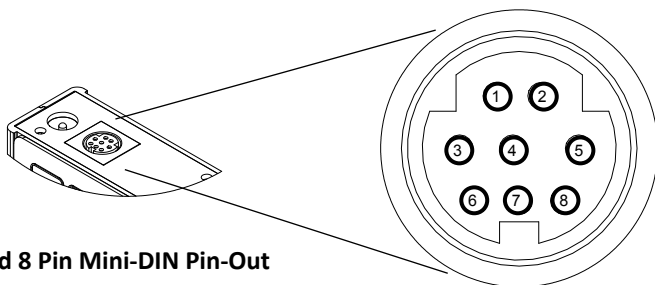

Standard 8 Pin Mini-DIN Pin-Out

Pin	Function	Mini-DIN cable color
1	Inactive (or optional 4-20mA Primary Output Signal)	Black
2	Static 5.12 Vdc [or optional Secondary Analog Output (4-20mA, 5Vdc, 10Vdc) or Basic Alarm]	Brown
3	Serial RS-232RX / RS-485(-) Input Signal (receive)	Red
4	Meters/Gauges = Remote Tare (Ground to Tare) Controllers = Analog Set-Point Input	Orange
5	Serial RS-232TX / RS-485(+) Output Signal (send)	Yellow
6	0-5 Vdc (or optional 0-10 Vdc) Output Signal	Green
7	Power In (as described above)	Blue
8	Ground (common for power, digital communications, analog signals and alarms)	Purple

**Note:** The above pin-out is applicable to all the flow meters and controllers with the Mini-DIN connector. The availability of different output signals depends on the options ordered. Optional configurations are noted on the unit's calibration sheet.

## Locking Industrial Connector Pin-Outs

If your Alicat Instrument was ordered with a Six Pin Locking Industrial connection, please be sure to reference the following pin-out diagram.

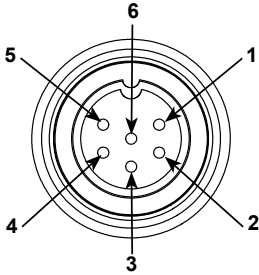

**Male Connector: Cable**

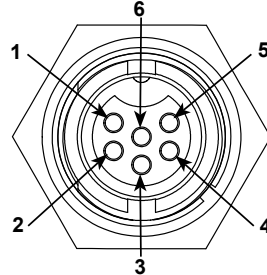

**Female Connector: Device**

Pin	Function
1	Power In ( + )
2	RS-232TX / RS-485(+)
3	RS-232RX / RS-485(-)
4	Meters/Gauges = Remote Tare (Ground to Tare) Controllers = Analog Set-Point Input
5	Ground (common for power, communications and signals)
6	Signal Out (Voltage or Current as ordered)



The above pin-out is applicable to all the flow meters and controllers ordered with the industrial connector. The availability of different output signals depends on the flow meter options ordered.



If your instrument was ordered with a DB9 connection, be sure to check the Calibration Label on the device and reference the appropriate pin-out diagram.

## Standard DB9 Pin-out

The following pin-out chart describes the safest and generally compatible arrangement when connecting a non-Alicat DB9 wire to a **DB9** equipped Alicat. Not all features may be available between brands, but the common denominators are featured in our DB9 offerings, along with some options for customization.

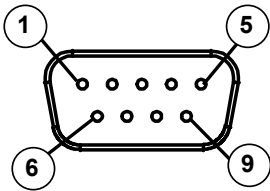

**Male Connector Front View**

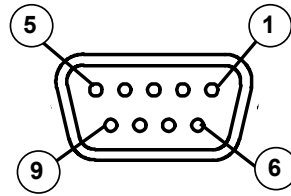

**Female Connector Front View**

Pin	Function
1	Not Connected (4-20mA analog output signal optional)
2	5.12 Vdc or (secondary analog output (4-20mA, 5Vdc, 10Vdc or alarm optional)
3	Serial RS-232RX or RS-485(-)
4	Analog Input Signal [4-20mA, 5Vdc, or 10Vdc] (short to ground for remote tare function on non-controllers)
5	Serial RS-232TX or RS-485(+)
6	0-5 Vdc Output Signal (or 0-10 Vdc optional)
7	Power In (+Vdc)
8	Ground (common for power, digital communications, analog signals and alarms)
9	Ground (common for power, digital communications, analog signals and alarms)

**Note:** The above pin-out is applicable to all the flow meters and controllers with the **DB9** connector. The availability of different output signals depends on the options ordered. Optional configurations are noted on the unit's calibration sheet.



**Do not connect RS-485 to RS-232 units or cables. Damage will occur! Check part number or contact factory to verify RS-485 functionality.**



Due to variance in cable manufacturing, please identify proper wiring/pins via continuity check & color when using blunt cut multi-strand cables.



If your instrument was ordered with a DB9 connection, be sure to check the Calibration Label on the device and reference the appropriate pin-out diagram.

## DB9A Pin-out

The following pin-out chart describes the safest and generally compatible arrangement when connecting a non-Alicat DB9 wire to a **DB9A** equipped Alicat. Not all features may be available between brands, but the common denominators are featured in our DB9N offerings, along with some options for customization.

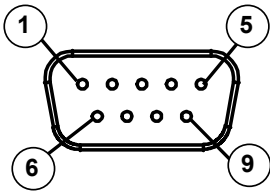

**Male Connector Front View**

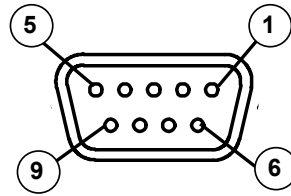

**Female Connector Front View**

Pin	Function
1	Not Connected
2	0-5 Vdc Output Signal (or 0-10 Vdc optional)
3	Power In (+Vdc)
4	Ground (common for power, digital communications, analog signals and alarms)
5	Serial RS-232TX or RS-485 (+)
6	Analog Input Signal [4-20mA, 5Vdc, or 10Vdc] (short to ground for remote tare function on non-controllers)
7	Ground (common for power, digital communications, analog signals and alarms)
8	Ground (common for power, digital communications, analog signals and alarms)
9	Serial RS-232RX or RS-485 (-)

**Note:** The above pin-out is applicable to all the flow meters and controllers with the **DB9A** connector. The availability of different output signals depends on the options ordered. Optional configurations are noted on the unit's calibration sheet.



**Do not connect RS-485 to RS-232 units or cables. Damage will occur! Check part number or contact factory to verify RS-485 functionality.**



Due to variance in cable manufacturing, please identify proper wiring/pins via continuity check & color when using blunt cut multi-strand cables.



If your instrument was ordered with a DB9 connection, be sure to check the Calibration Label on the device and reference the appropriate pin-out diagram.

## DB9N Pin-out

The following pin-out chart describes the safest and generally compatible arrangement when connecting a non-Alicat DB9 wire to a **DB9N** equipped Alicat. Not all features may be available between brands, but the common denominators are featured in our DB9N offerings, along with some options for customization.

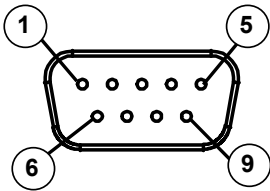

Male Connector Front View

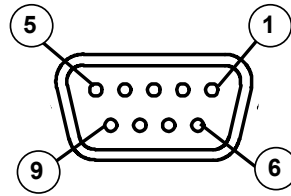

Female Connector Front View

Pin	Function
1	Power In (+Vdc)
2	Analog Input Signal [4-20mA, 5Vdc, or 10Vdc] (short to ground for remote tare function on non-controllers)
3	0-5 Vdc Output Signal (or 0-10 Vdc optional)
4	Not Connected
5	Ground (common for power, digital communications, analog signals and alarms)
6	Ground (common for power, digital communications, analog signals and alarms)
7	Serial RS-232RX or RS-485 (-)
8	Serial RS-232TX or RS-485 (+)
9	Not Connected
<p><b>Note:</b> The above pin-out is applicable to all the flow meters and controllers with the <b>DB9N</b> connector. The availability of different output signals depends on the options ordered. Optional configurations are noted on the unit's calibration sheet.</p>	



**Do not connect RS-485 to RS-232 units or cables. Damage will occur! Check part number or contact factory to verify RS-485 functionality.**



Due to variance in cable manufacturing, please identify proper wiring/pins via continuity check & color when using blunt cut multi-strand cables.



If your instrument was ordered with a DB9 connection, be sure to check the Calibration Label on the device and reference the appropriate pin-out diagram.

## DB9R Pin-out

The following pin-out chart describes the safest and generally compatible arrangement when connecting a non-Alicat DB9 wire to a **DB9R** equipped Alicat. Not all features may be available between brands, but the common denominators are featured in our DB9R offerings, along with some options for customization.

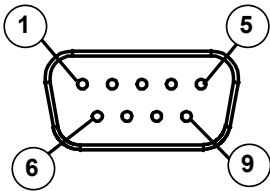

**Male Connector Front View**

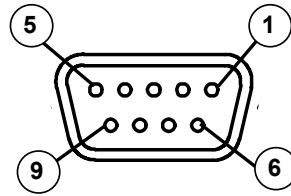

**Female Connector Front View**

Pin	Function
1	Serial RS-232TX or RS-485 (+)
2	0-5 Vdc Output Signal (or 0-10 Vdc optional)
3	Analog Input Signal [4-20mA, 5Vdc, or 10Vdc] (short to ground for remote tare function on non-controllers)
4	Ground (common for power, digital communications, analog signals and alarms)
5	Not Connected
6	Serial RS-232RX or RS-485 (-)
7	Power In (+Vdc)
8	Ground (common for power, digital communications, analog signals and alarms)
9	Ground (common for power, digital communications, analog signals and alarms)

**Note:** The above pin-out is applicable to all the flow meters and controllers with the **DB9R** connector. The availability of different output signals depends on the options ordered. Optional configurations are noted on the unit's calibration sheet.



**Do not connect RS-485 to RS-232 units or cables. Damage will occur! Check part number or contact factory to verify RS-485 functionality.**



Due to variance in cable manufacturing, please identify proper wiring/pins via continuity check & color when using blunt cut multi-strand cables.



If your instrument was ordered with a DB9 connection, be sure to check the Calibration Label on the device and reference the appropriate pin-out diagram.

## DB9T Pin-out

The following pin-out chart describes the safest and generally compatible arrangement when connecting a non-Alicat DB9 wire to a **DB9T** equipped Alicat. Not all features may be available between brands, but the common denominators are featured in our DB9T offerings, along with some options for customization.

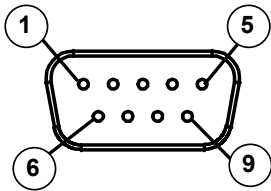

**Male Connector Front View**

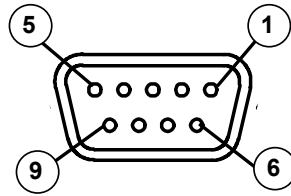

**Female Connector Front View**

Pin	Function
1	Serial RS-232TX or RS-485 (+)
2	0-5 Vdc Output Signal (or 0-10 Vdc optional)
3	Power In (+Vdc)
4	Ground (common for power, digital communications, analog signals and alarms)
5	Not Connected
6	Analog Input Signal [4-20mA, 5Vdc, or 10Vdc] (short to ground for remote tare function on non-controllers)
7	Ground (common for power, digital communications, analog signals and alarms)
8	Ground (common for power, digital communications, analog signals and alarms)
9	Serial RS-232RX or RS-485 (-)
<p><b>Note:</b> The above pin-out is applicable to all the flow meters and controllers with the <b>DB9T</b> connector. The availability of different output signals depends on the options ordered. Optional configurations are noted on the unit's calibration sheet.</p>	



**Do not connect RS-485 to RS-232 units or cables. Damage will occur! Check part number or contact factory to verify RS-485 functionality.**



Due to variance in cable manufacturing, please identify proper wiring/pins via continuity check & color when using blunt cut multi-strand cables.



If your instrument was ordered with a DB9 connection, be sure to check the Calibration Label on the device and reference the appropriate pin-out diagram.

## DB9U Pin-out

The following pin-out chart describes the safest and generally compatible arrangement when connecting a non-Alicat DB9 wire to a **DB9U** equipped Alicat. Not all features may be available between brands, but the common denominators are featured in our DB9U offerings, along with some options for customization.

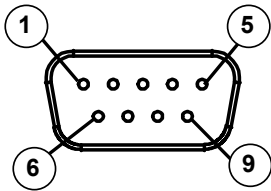

**Male Connector Front View**

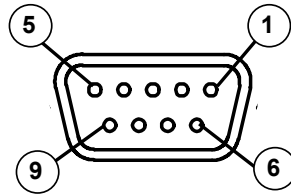

**Female Connector Front View**

Pin	Function
1	Serial RS-232RX or RS-485(-)
2	0-5 Vdc Output Signal (or 0-10 Vdc optional)
3	Power In (+Vdc)
4	Ground (common for power, digital communications, analog signals and alarms)
5	Not Connected
6	Analog Input Signal [4-20mA, 5Vdc, or 10Vdc] (short to ground for remote tare function on non-controllers)
7	Ground (common for power, digital communications, analog signals and alarms)
8	Ground (common for power, digital communications, analog signals and alarms)
9	Serial RS-232TX or RS-485(+)

**Note:** The above pin-out is applicable to all the flow meters and controllers with the **DB9U** connector. The availability of different output signals depends on the options ordered. Optional configurations are noted on the unit's calibration sheet.



**Do not connect RS-485 to RS-232 units or cables. Damage will occur! Check part number or contact factory to verify RS-485 functionality.**



Due to variance in cable manufacturing, please identify proper wiring/pins via continuity check & color when using blunt cut multi-strand cables.



# DB15 Pin-Outs

If your instrument was ordered with a DB15 connection, be sure to check the Calibration Label on the device and reference the appropriate pin-out diagram.

The following pin-out chart describes the safest and generally compatible arrangement when connecting a non-Alicat DB15 wire to a **DB15** equipped Alicat. Not all features may be available between brands, but the common denominators are featured in our DB15 offerings, along with some options for customization.

## DB15 – Pin-Out Alicat Style

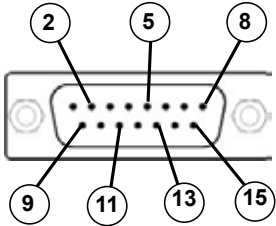

Male Connector Front View

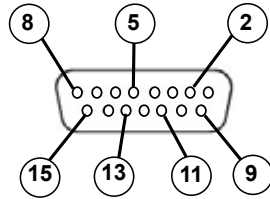

Female Connector Front View

Pin Number	Function
1	Ground
2	Primary Analog Signal Output
3	Ground
4	N/C
5	Power Supply (+Vdc)
6	N/C
7	N/C
8	Analog Tare (meters — when grounded) Analog Set-Point Input (controllers)
9	Power Supply Common
10	Ground
11	Secondary Analog Signal Output / fixed 5.12Vdc
12	N/C
13	RS-232 RX (receive) or RS-485 –
14	Ground
15	RS-232 TX (send) or RS-485 +

Check your device's calibration certificate and user manual for the actual electrical input/output requirements, as all instruments are custom configured to some extent.

**NOTE:** Pins 1, 3, 9, 10, and 14 are connected together inside of the device and are common grounding points.

**N/C** = Not Connected/Open (can be used for custom pin assignments – please consult factory).

# DB15 Pin-Outs

If your instrument was ordered with a DB15 connection, be sure to check the Calibration Label on the device and reference the appropriate pin-out diagram.

The following pin-out chart describes the safest and generally compatible arrangement when connecting a non-Alicat DB15 wire to a **DB15A** equipped Alicat. Not all features may be available between brands, but the common denominators are featured in our DB15 offerings, along with some options for customization.

## DB15A – Pin-Out “Aalborg XFM” Style

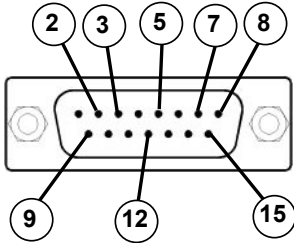

Male Connector Front View

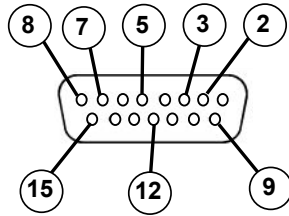

Female Connector Front View

Pin Number	Function
1	Ground
2	Primary Analog Signal Output
3	Analog Tare (meters — when grounded)* Analog Set-Point Input (controllers)*
4	Ground
5	Power Supply Common
6	Ground
7	Power Supply (+Vdc)
8	RS-232 Tx (send) / RS-485 –
9	Ground
10	N/C
11	N/C
12	Secondary Analog Signal Output / fixed 5.12Vdc*
13	N/C
14	N/C
15	RS-232 Rx (receive) / RS-485 +

Check your device’s calibration certificate and user manual for the actual electrical input/output requirements, as all instruments are custom configured to some extent.

\* Added to allow for full use of features on Alicat devices, may not be present on host wiring

**NOTE:** Pins 1, 4, 5, 6 and 9 are connected together inside of the device and are common grounding points.

**N/C** = Not Connected/Open (can be used for custom pin assignments – please consult factory).

# DB15 Pin-Outs

If your instrument was ordered with a DB15 connection, be sure to check the Calibration Label on the device and reference the appropriate pin-out diagram.

The following pin-out chart describes the safest and generally compatible arrangement when connecting a non-Alicat DB15 wire to a **DB15B** equipped Alicat. Not all features may be available between brands, but the common denominators are featured in our DB15 offerings, along with some options for customization.

## DB15B – Pin-Out “Brooks” Style

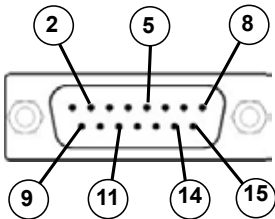

Male Connector Front View

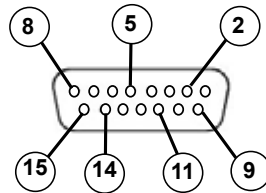

Female Connector Front View

Pin Number	Function
1	Ground
2	Primary Analog Signal Output
3	N/C
4	N/C
5	Power Supply (+Vdc)
6	N/C
7	N/C
8	Analog Tare (meters — when grounded)* Analog Set-Point Input (controllers)*
9	Power Supply Common
10	Ground
11	Secondary Analog Signal Output / fixed 5.12Vdc
12	N/C
13	N/C
14	RS-232 RX (receive) or RS-485 —*
15	RS-232 TX (send) or RS-485 +*

Check your device's calibration certificate and user manual for the actual electrical input/output requirements, as all instruments are custom configured to some extent.

**NOTE:** Pins 1, 9, and 10 are connected together inside of the device and are common grounding points.

**N/C** = Not Connected/Open (can be used for custom pin assignments – please consult factory).

\* Added to allow for full use of features on Alicat devices, may not be present on host wiring

# DB15 Pin-Outs

If your instrument was ordered with a DB15 connection, be sure to check the Calibration Label on the device and reference the appropriate pin-out diagram.

The following pin-out chart describes the safest and generally compatible arrangement when connecting a non-Alicat DB15 wire to a **DB15K** equipped Alicat. Not all features may be available between brands, but the common denominators are featured in our DB15 offerings, along with some options for customization.

## DB15K – Pin-Out “MKS” Style

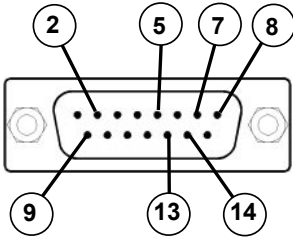

Male Connector Front View

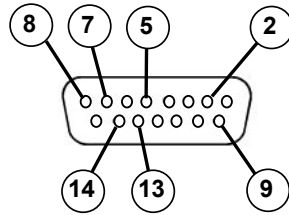

Female Connector Front View

Pin Number	Function
1	N/C
2	Primary Analog Signal Output
3	N/C
4	N/C
5	Power Supply Common
6	N/C
7	Power Supply (+Vdc)
8	Analog Tare (meters — when grounded) Analog Set-Point Input (controllers)
9	Secondary Analog Signal Output / fixed 5.12Vdc *
10	N/C
11	Ground
12	Ground
13	RS-232 RX (receive) or RS-485 - *
14	RS-232 TX (send) or RS-485 + *
15	Ground

Check your device's calibration certificate and user manual for the actual electrical input/output requirements, as all instruments are custom configured to some extent.

**NOTE:** Pins 5, 11, 12 and 15 are connected together inside of the device and are common grounding points.

**N/C** = Not Connected/Open (can be used for custom pin assignments – please consult factory).

\* Added to allow for full use of features on Alicat devices, may not be present on host wiring.

# DB15 Pin-Outs

If your instrument was ordered with a DB15 connection, be sure to check the Calibration Label on the device and reference the appropriate pin-out diagram.

The following pin-out chart describes the safest and generally compatible arrangement when connecting a non-Alicat DB15 wire to a **DB15H** equipped Alicat. Not all features may be available between brands, but the common denominators are featured in our DB15 offerings, along with some options for customization.

## DB15H – Pin-Out “Hastings H” Style

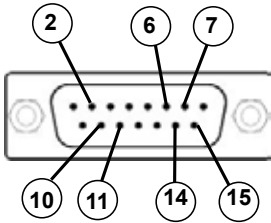

Male Connector Front View

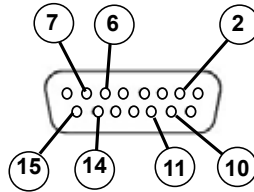

Female Connector Front View

Pin Number	Function
1	N/C
2	RS-232 RX (receive) or RS-485 – *
3	N/C
4	N/C
5	Ground
6	Primary Analog Signal Output
7	Power Supply Common
8	N/C
9	N/C
10	Secondary Analog Signal Output / fixed 5.12Vdc *
11	Power Supply (+Vdc)
12	Ground
13	N/C
14	Analog Tare (meters — when grounded) Analog Set-Point Input (controllers)
15	RS-232 TX (send) or RS-485 + *

Check your device's calibration certificate and user manual for the actual electrical input/output requirements, as all instruments are custom configured to some extent.

**NOTE:** Pins 5, 7 and 12 are connected together inside of the device and are common grounding points.

**N/C** = Not Connected/Open (can be used for custom pin assignments – please consult factory).

\* Added to allow for full use of features on Alicat devices, may not be present on host wiring.

# DB15 Pin-Outs

If your instrument was ordered with a DB15 connection, be sure to check the Calibration Label on the device and reference the appropriate pin-out diagram.

The following pin-out chart describes the safest and generally compatible arrangement when connecting a non-Alicat DB15 wire to a DB15O equipped Alicat. Not all features may be available between brands, but the common denominators are featured in our DB15 offerings, along with some options for customization.

## DB15O – Pin-Out "Brooks" variant

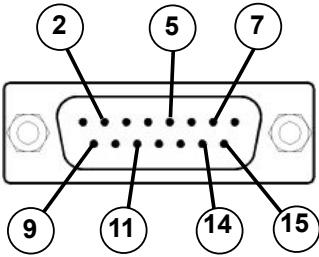

Male Connector Front View

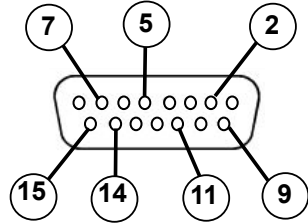

Female Connector Front View

Pin Number	Function
1	Ground
2	N/C
3	N/C
4	Primary Analog Signal Output
5	Power Supply (+Vdc)
6	N/C
7	Analog Tare (meters — when grounded)* Analog Set-Point Input (controllers)*
8	N/C
9	Power Supply Common
10	Ground
11	Secondary Analog Signal Output / fixed 5.12Vdc
12	N/C
13	N/C
14	RS-232 RX (receive) or RS-485 -*
15	RS-232 TX (send) or RS-485 +*

Check your device's calibration certificate and user manual for the actual electrical input/output requirements, as all instruments are custom configured to some extent.

**NOTE:** Pins 1, 9, and 10 are connected together inside of the device and are common grounding points.

**N/C** = Not Connected/Open (can be used for custom pin assignments – please consult factory).

\* Added to allow for full use of features on Alicat devices, may not be present on host wiring

# DB15 Pin-Outs

If your instrument was ordered with a DB15 connection, be sure to check the Calibration Label on the device and reference the appropriate pin-out diagram.

The following pin-out chart describes the safest and generally compatible arrangement when connecting a non-Alicat DB15 wire to a **DB15S** equipped Alicat. Not all features may be available between brands, but the common denominators are featured in our DB15 offerings, along with some options for customization.

## DB15S – Pin-Out “Sierra” Style

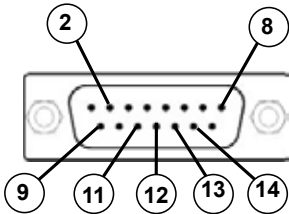

Male Connector Front View

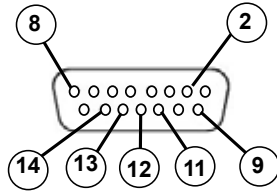

Female Connector Front View

Pin Number	Function
1	Ground
2	Primary Analog Signal Output
3	N/C
4	N/C
5	Ground
6	N/C
7	N/C
8	Analog Tare (meters — when grounded) Analog Set-Point Input (controllers)
9	Power Supply Common
10	Ground
11	Secondary Analog Signal Output / fixed 5.12Vdc *
12	RS-232 RX (receive) or RS-485 – *
13	Power Supply (+Vdc)
14	RS-232 TX (send) or RS-485 + *
15	Ground

Check your device's calibration certificate and user manual for the actual electrical input/output requirements, as all instruments are custom configured to some extent.

**NOTE:** Pins 1, 5, 9, 10 and 15 are connected together inside of the device and are common grounding points.

**N/C** = Not Connected/Open (can be used for custom pin assignments – please consult factory).

\* Added to allow for full use of features on Alicat devices, may not be present on host wiring.

## NOTES FOR USING PC-EXTSEN DEVICES

**PC-EXTSEN** units connect a Pressure Controller (with no internal pressure sensor) to an end-user supplied external pressure sensor. Designed mainly for the vacuum coating industry, the PC-EXTSEN marries the sensing ability of an existing capacitance manometer or ion gauge with a Alicat's 16 Series electronics package and internal PID algorithm. This enables fast and precise control of extreme vacuum conditions in the coating chamber.

The PC-EXTSEN receives a linear analog signal from the external sensor. This analog signal corresponds to a full scale range that is specified by the user at the time of order (and corresponds to the scale of the external sensor). The PC-EXTSEN interprets this analog signal as its sensed pressure.

The PC-EXTSEN then utilizes its proportional control valve to control the flow of gas into the chamber, allowing for closed loop vacuum control based on the interpreted signal. Set-point control and PID tuning all happen through the instrument's interface, via the buttons on the display, or a user selected analog interface (0-5V, 0-10V, or 4-20mA), or through a multidrop RS-232 interface.

There are two base models of PC-EXTSEN controllers, the **PC-EXTSEN-D**, and the **PC-EXTSEN-D-ISC**.

The **PC-EXTSEN-D** has an 8 pin Mini-DIN female electrical connector as its electrical connection to power, ground, signal input from the external sensor, RS-232 transmit and receive, as well as analog transmit and receive. The PC-EXTSEN-D also has a barrel plug electrical connection if you choose to power the device through a wall mounted AC adaptor, rather than wiring power to the 8 pin minidin connection.

The **PC-EXTSEN-D-ISC** is identical to the PC-EXTSEN-D except it has an additional locking 6 pin industrial electrical connector which is intended for use as a dedicated connection to your external sensor, leaving the 8 pin Mini-DIN connection available to be used as a dedicated RS-232 or analog interface connection.



**When using a PC-EXTSEN-D-ISC device, it is recommended that power and communications to the PC-EXTSEN-D-ISC device be wired through the 8 pin Mini-DIN connector and that the industrial connector is maintained as a dedicated connection to the external sensor.**

**WHEN USING THE INDUSTRIAL CONNECTOR AS A DEDICATED CONNECTION TO THE SENSOR, DO NOT WIRE ANY SIGNAL INPUT INTO PIN 2 ON THE Mini-DIN CONNECTOR.**

**Please refer to the appropriate sections of this operating manual for complete information regarding use and tuning of your PC-EXTSEN controller.**



## POWER AND SIGNAL CONNECTIONS

Power can be supplied to your controller through either the power jack or the 8 pin Mini-DIN connector.

An AC to DC adapter which converts line AC power to DC voltage and current as specified below is required to use the power jack.

A 2.1mm, positive center, 12-30 Vdc AC/DC adapter rated for at least 250 mA is required to use the adapter jack in a **PC-Series controller**.

A 2.1mm, positive center, 24-30 Vdc AC/DC adapter rated for at least 500 mA is required to use the adapter jack in a **PCR-Series controller**.

**NOTE:** 4-20mA analog output requires at least 15 Vdc.

## PC-EXTSEN-D Pin-Outs

The following pin-out diagram is applicable to all standard PC-EXTSEN-D devices. If your device was ordered with custom pin-out requirements, please contact Alicat for assistance.

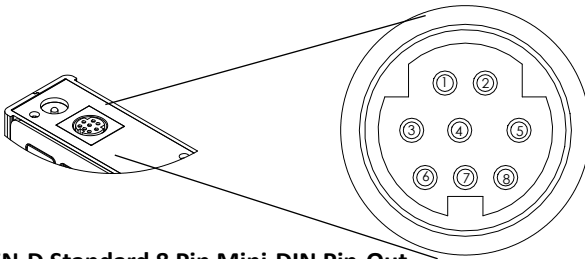

### PC-EXTSEN-D Standard 8 Pin Mini-DIN Pin-Out

Pin	Function	Mini-DIN cable color
1	Inactive or <u>4-20mA Primary Output Signal</u>	Black
2	<b>External Sensor Signal Input*</b>	<b>Brown</b>
3	RS-232 Input Signal	Red
4	Analog Input Signal	Orange
5	RS-232 Output Signal	Yellow
6	<u>0-5 Vdc (or 0-10 Vdc) Output Signal</u>	Green
7	Power In	Blue
8	Ground (common for power, communications and signals)	Purple

\*If you are using the PC-EXTSEN-D-ISC's 6 pin locking connection to receive the external sensor input signal do not wire any signal into pin 2 of the Mini-DIN.



**Pin 7** which is normally utilized to provide power into the Alicat device can be used to provide power to your external sensor. Please make sure that the power you are providing to the device is compatible with the power your sensor can accept before choosing to wire power in this manner.



**CAUTION! Do NOT CONNECT POWER TO PINS 1 THROUGH 6 AS PERMANENT DAMAGE CAN OCCUR!**

## PC-EXTSEN-D-ISC Pin-Outs

The PC-EXTSEN-D-ISC is equipped with an additional Six Pin Locking connection, for use as a dedicated connection to your external sensor.

This leaves the 8 pin Mini-DIN connection available to be used as a dedicated RS-232 or analog interface connection.

Please be sure to reference the following pin-out diagram. The following pin-out diagram is applicable to all standard PC-EXTSEN-D-ISC devices. If your device was ordered with custom pin-out requirements, please contact Alicat for assistance.

Pin	Function	Cable Color
1	Power In ( + )	Red
2	In-Active	Blue
3	In-Active	White
4	<b>External Sensor Signal Input</b>	<b>Green</b>
5	Ground (common for power, communications and signals)	Black
6	In-Active	Brown

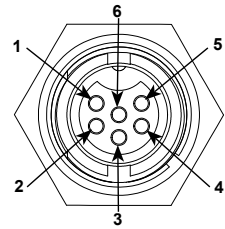

Female Connector: Device

### PC-EXTSEN-D-ISC Standard 6 Pin Locking Connection Pin-Out

**➔ The 6 pin locking connection on the –ISC unit has only three active pins, power, ground and signal input from the external sensor.**

**➔ Pin 1** which is normally utilized to provide power into the Alicat device can be used to provide power to your external sensor. Please make sure that the power you are providing to the device is compatible with the power your sensor can accept before choosing to wire power in this manner.

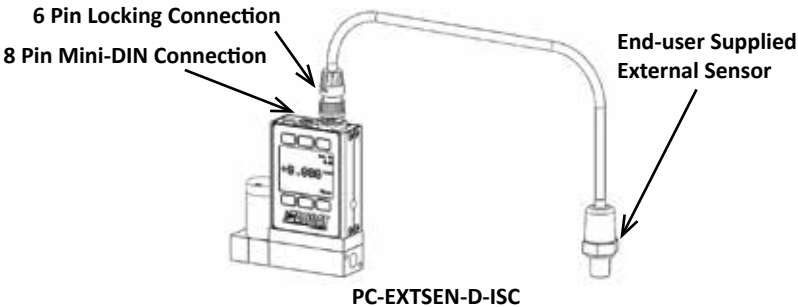

PC-EXTSEN-D-ISC

**➔ When using a PC-EXTSEN-D-ISC device, it is recommended that power and communications to the PC-EXTSEN-D-ISC device be wired through the 8 pin connector and that the industrial connector is maintained as a dedicated connection to the external sensor.**

**WHEN USING THE INDUSTRIAL CONNECTOR AS A DEDICATED CONNECTION TO THE SENSOR, DO NOT WIRE ANY SIGNAL INPUT INTO PIN 2 ON THE Mini-DIN CONNECTOR.**

## Additional Information for Alicat CSA and ATEX Approved Devices



EEx nA IIC T4

Class I, Div. 2 Group A, B, C and D T4

24 Vdc, 0.800A max

Class I, Zone 2 AEx nA IIC T4



### WARNINGS:

**EXPLOSION HAZARD** – DO NOT DISCONNECT WHILE CIRCUIT IS LIVE UNLESS AREA IS KNOWN TO BE NON-HAZARDOUS.

**EXPLOSION HAZARD** – SUBSTITUTION OF COMPONENTS MAY IMPAIR SUITABILITY FOR CLASS I, DIVISION 2.

Alicat CSA / ATEX approved devices are equipped with either a locking six pin industrial connector (IC), locking D-sub 15 pin connector (DB15) or locking D-sub 9 pin connector (DB9). Please see pages 75 - 87 for the correct power and signal connections for each type of connector.

**See the following page for special conditions regarding the use of these units!**

**USE of Alicat instruments (L, LC, LCR, M, MW, MS, MC, MCW, MCS, MCR, MCRW, MCRS, P, PS, PC, PCS, PCR and PCRS product families only) in Class 1 Division 2 applications.**



CSA certifies the use of this product for general use as well as use in hazardous locations as defined by Class 1 Division 2 Group A, B, C and D T4.

**CSA certification is indicated by the product label as shown below and not by the statements in this, or any accompanying documentation.**

**Special Conditions:**

To comply with CSA certification the following information is included in the product literature:

- When equipment is properly labeled, it is suitable in Class I, Division 2, Group A, B, C and D, T4
  - Tamb. -40°C to +50°C
- Electrical Rating 24Vdc, 0.800A max
- Instruments shall be powered by a CSA certified, UL listed, Class II external power supply suitable for the application
- Instruments shall be housed in an enclosure with a minimum IP54 rating or location providing equivalent protection
- Instrument's final approval shall be provided by the local authority having jurisdiction

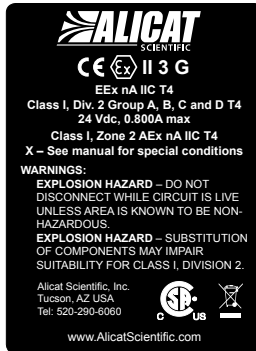

**USE of Alicat instruments (L, LC, LCR, M, MS, MC, MCS, MCR, MCRS, P, PS, PC, PCS, PCR and PCRS product families only) in applications requiring ATEX Certification.**

Properly labeled Alicat instruments comply to the following ATEX standard:



II 3 G EEx nA IIC T4 (-40°C ≤ Ta ≤ +50°C)

The examination certificate was issued by the CSA in accordance with accepted practices and procedures. This confirms compliance with the European ATEX Directive or Group II Category 3G equipment.

**ATEX certification is indicated by the product label as shown above and not by the statements in this, or any accompanying documentation.**

**Special Conditions:**

- Properly labeled equipment is only certified for use in ambient temperatures in the range of -40°C to +50°C only
- Electrical Rating 24Vdc, 0.800A max
- Instruments shall be powered by a CSA certified, UL listed, Class II external power supply suitable for the application
- Instruments shall be housed in an enclosure with a minimum IP54 rating or location providing equivalent protection
- Instrument's final approval shall be provided by the local authority having jurisdiction

**Serial Number:** \_\_\_\_\_

**Model Number:** \_\_\_\_\_

Notice: Alicat Scientific, Inc. reserves the right to make any changes and improvements to the products described in this manual at any time and without notice. This manual is copyrighted. This document may not, in whole or in part, be copied, reproduced, translated, or converted to any electronic medium or machine readable form, for commercial purposes, without prior written consent from the copyright holder.

Note: Although we provide assistance on Alicat Scientific products both personally and through our literature, it is the complete responsibility of the user to determine the suitability of any product to their application.

### **Limited Lifetime Warranty**

Alicat Scientific, Inc. warrants to the original purchaser (hereinafter referred to as "Buyer") that instruments manufactured by Alicat Scientific (hereinafter referred to as "Product") shall be free from defects in materials and workmanship for the life of the Products.

Under this warranty, the Products will be repaired or replaced at manufacturer's option, without charge for parts or labor when the Product is carried or shipped prepaid to the factory together with proof of purchase. The foregoing shall constitute the exclusive and sole remedy in lieu of other remedies of the Buyer for any breach by Alicat Scientific of this warranty to the maximum extent permitted by law.

This warranty does not apply to any Product which has not been installed or used in accordance with the Product operation and installation specifications provided to Buyer verbally or in writing by Alicat Scientific for the proper and normal use of the Product.

Buyer agrees hereunder that Alicat reserves the right to void any warranty, written or implied, if upon Alicat's examination of Product shall disclose to Alicat's satisfaction that the Product failure was due solely, or in part, to accident, misuse, neglect, abuse, alteration, improper installation, unauthorized repair or improper testing by Buyer or agent of Buyer.

Alicat Scientific shall not be liable under any circumstances for indirect, special, consequential, or incidental damages in connection with, or arising out of, the sale, performance, or use of the Products covered by this warranty.

Alicat Scientific does not recommend, warrant or assume responsibility for the use of the Products in life support applications or systems.

Alicat's warranties as herein above set forth shall not be enlarged, diminished or affected by, and no obligation or liability shall arise or grow out of Alicat's rendering of technical advice in connection with Buyer's order of the Products furnished hereunder.

If Product becomes obsolete, Alicat Scientific, at its own discretion, reserves the right to repair the Product with available replacement parts or upgrade the Product to a current, commercially available version of the original Product. Should upgrading the Product be deemed necessary by Alicat, Buyer hereby agrees to pay an upgrade fee equal to seventy percent of the retail value of the replacement Product. Alicat Scientific hereunder makes no claim that replacement Products will look, function or operate in the same or similar manner as the original product.

When a Product is returned to Alicat Scientific for recalibration this service is considered normal preventative maintenance. Recalibration of Product shall not be treated as a warranty service unless recalibration of Product is required as the result of repairs to Product pursuant to this Warranty. Failure of Buyer to send Product to Alicat Scientific for recalibration on a yearly basis after a period of 36 months from date of manufacture will remove any and all obligations regarding repair or replacement of Product as outlined by this Warranty to Buyer from Alicat Scientific.

This Warranty is in lieu of all other relevant warranties, expressed or implied, including the implied warranty of merchantability and the implied warranty of fitness for a particular purpose, and any warranty against infringement of any patent.

Continued use or possession of Products after expiration of the applicable warranty period stated above shall be conclusive evidence that the warranty is fulfilled to the full satisfaction of Buyer.

Alicat makes no warranty as to experimental, non-standard or developmental Products.

Accessories purchased from Alicat are not covered by this warranty.

Conformity / Supplemental Information:

The product complies with the requirements of the Low Voltage Directive 2006/95/EC and the EMC Directive 2004/108/EC and carries the CE Marking accordingly. Contact the manufacturer for more information.

## Gas Viscosity, Density and Compressibility:

#	Gas	Absolute Viscosity* 25°C	Density ** 25°C psia	Compressibility 25°C psia	
0	Air	184.8989	1.1840	0.9997	
1	Argon	226.2399	1.6339	0.9994	
2	Methane	110.7595	0.6569	0.9982	
3	Carbon Monoxide	176.4933	1.1453	0.9996	
4	Carbon Dioxide	149.3184	1.8080	0.9950	
5	Ethane	93.5412	1.2385	0.9924	
6	Hydrogen	H2	89.1535	0.08235	1.0006
7	Helium	He	198.4561	0.16353	1.0005
8	Nitrogen	N2	178.0474	1.1453	0.9998
9	Nitrous Oxide	N2O	148.4124	1.8089	0.9945
10	Neon	Ne	311.1264	0.8244	1.0005
11	Oxygen	O2	205.5021	1.3088	0.9994
12	Propane	C3H8	81.4631	1.8320	0.9838
13	normal-Butane	n-C4H10	74.0536	2.4493	0.9699
14	Acetylene	C2H2	104.4480	1.0720	0.9928
15	Ethylene	C2H4	103.1839	1.1533	0.9943
16	iso-Butane	i-C4H10	74.7846	2.4403	0.9735
17	Krypton	Kr	251.3249	3.4323	0.9979
18	Xenon	Xe	229.8483	5.3950	0.9947
19	Sulfur Hexafluoride	SF6	153.5320	6.0383	0.9887

## Flow Conversions:

SCFM	1.00 = 28.3160	SLPM	SLPM	100.00 = 3.5316	SCFM
SCFH	1.00 = 0.4719	SLPM	SLPM	100.00 = 211.9093	SCFH
SCIM	100.00 = 1.6390	SLPM	SLPM	1.00 = 61.0128	SCIM
SCIH	1000.00 = 0.2732	SLPM	SLPM	1.00 = 3660.7688	SCIH

[alicat.com](http://alicat.com)

#	Gas	Absolute Viscosity* 25°C	Density ** 25°C psia	Compressibility 25°C psia	
20	75%Ar / 25% CO2	C-25	206.9763	1.6766	0.9987
21	90%Ar / 10% CO2	C-10	218.6026	1.6509	0.9991
22	92% Ar / 8% CO2	C-8	220.1352	1.6475	0.9992
23	98% Ar / 2% CO2	C-2	224.7148	1.6373	0.9993
24	75% CO2 / 25% Ar	C-75	168.2250	1.7634	0.9966
25	75% Ar / 25% He	HE-75	231.6056	1.2660	0.9997
26	75% He / 25% Ar	HE-25	234.6860	0.5308	1.0002
27	90% He / 7.5% Ar / 2.5% CO2 Helistar® A1025	A1025	214.9760	0.3146	1.0003
28	90% Ar / 8% CO2 / 2% O2 Star29® CS	Star29	219.7934	1.6410	0.9992
29	95% Ar / 5% CH4	P-5	223.9106	1.5850	0.9993

\*In micropoise (1 Poise = gram / (cm) (sec))

\*\*Grams/Liter

Reference: NIST REFPROP 9 Database



SCIENTIFIC

7641 N Business Park Drive  
Tucson AZ 85743 USA

Phone: 888-290-6060

Fax: 520-290-0109

A HALMA COMPANY

The Fastest Flow Controller Company in the World!