

New Bio-Inert UHPLC Unions

- ▶ Unique, Patent-Pending Process allows a fully-PEEK fluid contact area combined with the strength of stainless steel
- ▶ Pressure rated to 1,200 bar (17,400 psi)
- ▶ Two inner diameters available: 0.008" and 0.016"

Upchurch Scientific® introduces two new unions specifically engineered for Bio-Inert UHPLC applications. Combining the physical strength of 316 stainless steel with the inertness and biocompatibility of an all-PEEK fluid pathway, these unions will work well in applications where pressures reach up to 17,400 psi (1,200 bar) — without allowing metal contact by the fluid.

Neither union comes with fittings, but can be paired successfully with any 10-32 coned fitting that uses a polymer nose or ferrule.

Note: All-stainless steel fittings should NOT be used with these unions, as they will damage the internal conical seat.

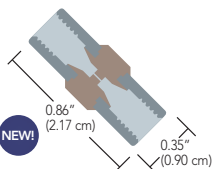
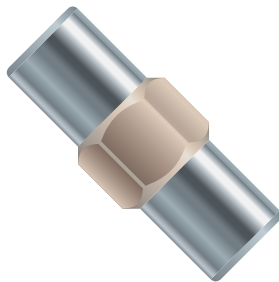

NEW!
UP-700
Bio-Inert UHPLC Union
0.008" thru-hole
for 1/16" OD tubing

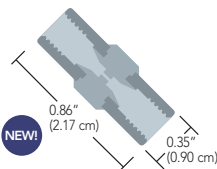

NEW!
UP-701
Bio-Inert UHPLC Union
0.016" thru-hole
for 1/16" OD tubing



PEEK ZDV Unions

Upchurch Scientific PEEK zero-dead-volume (ZDV) Unions come complete with two F-300 Fingertight Fittings for 1/16" OD tubing and are pressure rated to 5,000 psi (344 bar).

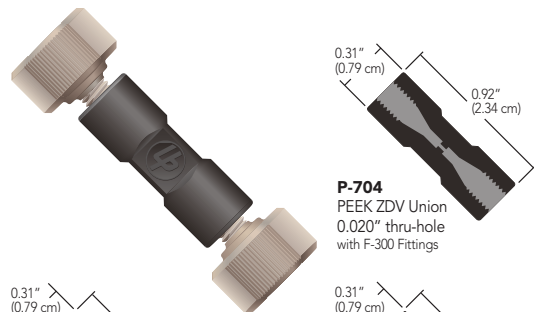

P-704
PEEK ZDV Union
0.020" thru-hole
with F-300 Fittings

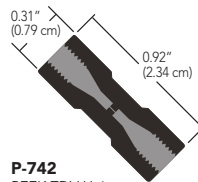

P-742
PEEK ZDV Union
0.010" thru-hole
with F-300 Fittings

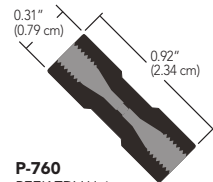

P-760
PEEK ZDV Union
0.050" thru-hole
with F-300 Fittings

NanoTight™ Union

This Upchurch Scientific NanoTight Union improves capillary tubing connections in several ways. The internal design of the union greatly reduces the incidence of tubing misalignment. When using 1/16" OD tubing sleeves (found on page 19) to connect capillary tubing, the webbed thru-hole minimizes breaking of fused silica while adding only minuscule swept volume. The results are fewer blockages, fewer flow rate reductions and fewer back pressure problems.

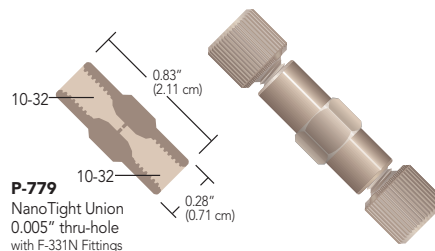

P-779
NanoTight Union
0.005" thru-hole
with F-331N Fittings

Part No.	Description	Threads	Includes	Thru-hole	Swept Volume	Pressure Rating
BIO-INERT UHPLC UNIONS						
NEW! UP-700	Bio-Inert UHPLC Union for 1/16" OD Tubing, Natural (Tan)	10-32 Coned	N/A	0.008" (0.20 mm)	0.05 µL	17,400 psi (1,200 bar)
NEW! UP-701	Bio-Inert UHPLC Union for 1/16" OD Tubing, Gray	10-32 Coned	N/A	0.016" (0.40 mm)	0.20 µL	17,400 psi (1,200 bar)
PEEK ZDV UNIONS						
★ P-704	PEEK Union for 1/16" OD Tubing	10-32 Coned	(2) F-300	0.020" (0.50 mm)	0.28 µL	5,000 psi (344 bar)
★ P-742	PEEK Union for 1/16" OD Tubing	10-32 Coned	(2) F-300	0.010" (0.25 mm)	0.07 µL	5,000 psi (344 bar)
★ P-760	PEEK Union for 1/16" OD Tubing	10-32 Coned	(2) F-300	0.050" (1.25 mm)	1.2 µL	5,000 psi (344 bar)
NANOTIGHT UNION						
★ P-779	PEEK NanoTight Union for 1/16" OD Tubing and Tubing Sleeves	10-32 Coned	(2) F-331N	0.005" (125 µm)	8 nL	5,000 psi (344 bar)