

## Femtomole Peptide Analysis by PicoFrit® Nanobore LC/MS at Low Pressures

### Introduction

The inherent chemical specificity and sensitivity of electrospray ionization mass spectrometry (ESI-MS) has led to the development of integrated nanoscale liquid chromatography (nLC) ESI systems.<sup>1,2</sup> In this approach, an appropriate ESI emitter is fabricated directly on the nLC column outlet. Method development has been severely limited by the difficult fabrication of suitable integrated nLC-ESI columns. Furthermore, instrumentation necessary for the generation of suitable sample injection and subsequent chromatography has been specialized and complex. The combination of a tapered, fritted fused-silica needle packed with a highporosity reverse-phase media eliminates these difficulties. This device, the PicoFrit®, provides purification, concentration, and separation at low column pressures. Low-pressure operation eliminates the need for specialized HPLC hardware, provides for short nLC run times, and allows direct integration with common syringe pumps and/or auto-samplers as shown in Figure 1.

### Column Fabrication

PicoFrit® columns were fabricated from fused-silica tubing with a 30 µm ID tip, an integral high-porosity frit, and multi-layer conductive coating (PF360-75-30-CE) as shown in Figure 2. Columns were syringe-packed with 10 µm POROS®, R2 phase media as follows: Approximately 200 ml of freshly ultrasonicated POROS slurry in MeOH (5 mg/ml) was drawn into a 500-ml gas-tight Luer-lock syringe (Hamilton Company). The distal end of a 50-cm ESI column was inserted into the barrel of the syringe using Luer/fused-silica adapter components from Upchurch Scientific®. Columns were packed by hand pressure alone; packing progress was monitored by light microscopy. When the desired length (about 5 cm) was reached, the column was rinsed with 50 ml of MeOH. Columns were dried for long-term storage with dry nitrogen at 500 psi for 15 minutes. Prior to use, columns were re-hydrated with MeOH and equilibrated with 1% acetic acid.

### Advantages of PicoFrit® Combined Column/Emitter

- Provides routine high-sensitivity, low-fmol limit of detection, for peptides on an ion trap in MS/MS mode
- Dirty and/or dilute peptide mixtures now easily run in ESI mode
- Zero post-column effects (e.g. sample loss, resolution loss)
- Capable of fast sample turn-around (< 5 min/run) for high throughput
- Packing the column in the tip eliminates problems with clogged tips
- Operable at low (syringe pump) pressures, eliminating the need for specialized hardware

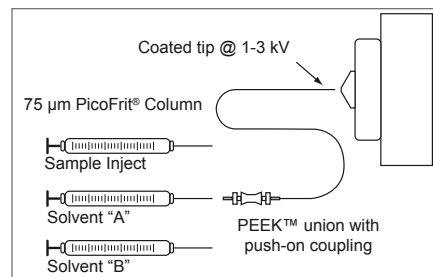

FIGURE 1 Linking a hand inject, rinse or syringe pump and a PicoFrit® on a Thermo Finnigan LCQ™

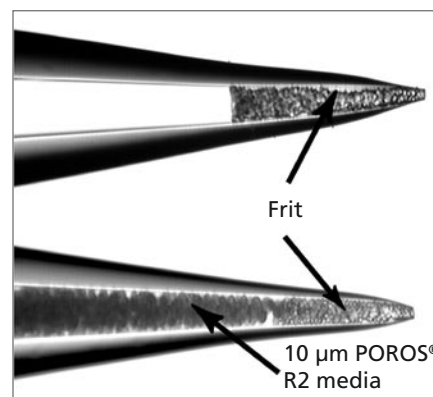

FIGURE 2 Unpacked (top) and pre-packed (bottom) PicoFrit® columns

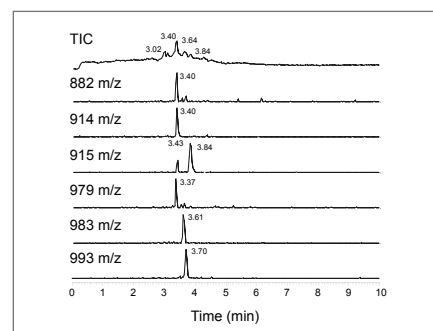

FIGURE 3 75 m x 47 mm (200 nL) POROS® R2, 30 m PicoFrit® @ 1 L/min 30:70:1 (ACN:H<sub>2</sub>O:HOAc) (10 L inj. 79 - 165 fmol/peptide)

## PicoFrit® Mounting Adapter for the QSTAR® Electropray Source

The ADPC-PRO kit enables the use of industry-standard PicoFrit® columns with your existing QSTAR® nanospray stage. The integrated sheath gas module provides for the use of coaxial sheath gas when using PicoFrit columns or TaperTip™ emitters from New Objective. Just thread the PicoFrit or TaperTip (distal end first) through the sheath gas tee and mount the tee on the XYZ platform. Electrical contact is made at the distal end of the PicoFrit column inside the uncoated tip module (UTM) which is easily mounted to the platform on the XYZ stage.

For safety reasons, this module is not compatible with standard- or distal-coated PicoTips®.

**WARNING:** Electropray ionization involves the use of potentially lethal high-voltage electrical current. Observe all manufacturers' safety recommendations in the use of such equipment. No equipment modifications should be made except by trained personnel using methods approved by the manufacturer in accordance with all safety requirements. Installation of equipment should be performed by qualified personnel in accordance with all applicable electrical codes.

Never use this product with defective, damaged, or faulty equipment. Serious injury or death could result.

**WARNING:** Only qualified personnel should use this product. Provide a safe workplace equipped with all necessary safety equipment.

**CAUTION:** Handling of fused-silica tubing and emitters can result in serious personal injury, including skin and eye injury. Use safety glasses or goggles meeting ANSI Z87.1-1989 requirements or the equivalent. Puncture- and chemical-resistant gloves should be worn at all times.

### Adapter Assembly

Before installing the ADPC-PRO slide the Protana source away from the source inlet and turn all voltages off.

#### Mounting the Adapter Plate to the XYZ Stage

- 1) Slide the ADPC-PRO adapter onto the metal rail located on the left side of the XYZ stage (Figure 1).
- 2) Using a hex key, lock the adapter into place by tightening the two 4-40 set screws as shown in Figure 2.

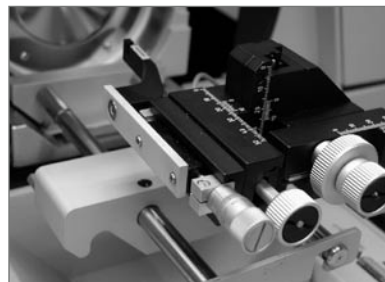

FIGURE 1

#### Mounting the Sheath Gas Tee Holder

- 1) Fasten the Sheath Gas Tee holder on the source arm using a thumb screw (see Figure 4).

#### Loading a Column into the Sheath Gas Module

- 1) Locate the Sheath Gas Tee.
- 2) Loosen the nut securing the SealTight™ fitting by one-half to two turns and feed a PicoFrit® or TaperTip™ through the PEEK™ nozzle, distal end first, until it comes through the SealTight sleeve (Figure 3).

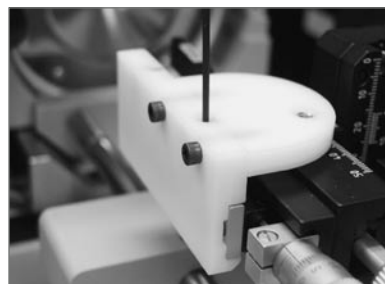

FIGURE 2

- 3) Pull the distal end of the emitter through the sleeve until the tip protrudes 0.5 to 2 mm past the end of the PEEK nozzle. Tighten the nut to lock the tip in place and ensure a gas-tight seal.
- 4) Load the stainless steel tee into the sheath gas mounting fixture with the tip-end protruding towards the inlet of the mass spectrometer as shown in Figure 4. Tighten the set screw (on the right-hand side of the fixture) so that the tee is held firmly in place.

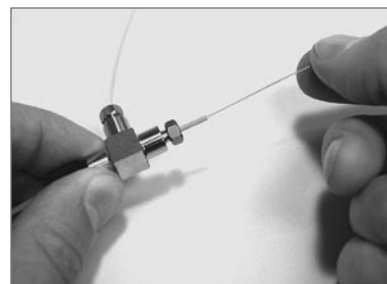

FIGURE 3

### Loading the Column into the UTM

High voltage will be applied through the uncoated tip module (UTM) to the distal end of the emitter.

- 1) If the UTM is not currently fastened to the adapter plate, fasten it to the plate using the long screw, as shown in Figure 5.
- 2) Remove the cover of the UTM using the thumb screw.
- 3) Trim the distal end of the TaperTip™ or PicoFrit® and connect to the MicroTee included with the UTM. See next section for further instructions on loading the MicroTee .
- 4) The other end of the MicroTee should be connected to your sample injector or mobile phase pumping system with fused-silica tubing.
- 5) Place the MicroTee into the UTM (Figure 6), replace the cover, and lock it into position.



FIGURE 4

**WARNING:** Reduce gas pressure to ambient before connecting to sheath gas line. Prior to pressurization, make sure components are tightened to specifications to prevent separation during use.

- 6) Connect the 1/16" OD sheath gas line to your mass spectrometer's sheath gas supply line. (Figure 7)
- 7) Reconnect the ESI high-voltage cable to the UTM (Figure 8). Carefully slide your nanospray source into the operating position. Use caution to make certain that the tip does not contact the mass spectrometer inlet before locking your source into operating position.
- 8) Adjust the position of the XYZ stage if necessary. You are now ready to initiate operation.



FIGURE 5

### Plumbing the MicroTee

The MicroTee joins the PicoTip® to the transfer line and supplies the high voltage.

- 1) Remove the MicroTee from the UTM. Orient the MicroTee so that the platinum electrode is facing away from the user and the setscrews are visible. Unscrew the nuts on each side and remove the black ferrules from the posts of the MicroTee.

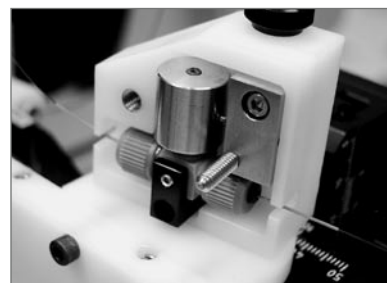

FIGURE 6

**WARNING:** Do not loosen the setscrews or remove the electrode cap, as this may damage the electrode. The solvent will not become charged and an electrospray will not form.

- 2) Thread the end of the transfer line tubing through a green MicroTight® sleeve, which is used for assembly with 360 µm OD tubing. Make sure the fused-silica transfer line does not extend past the tubing sleeve end that will be inserted into the MicroTee. Thread the sleeved transfer line through the fitting nut and a black ferrule (Figure 9A).
- 3) Cleave the end of the fused-silica transfer line after the tubing is threaded through the sleeve, nut, and ferrule. Slip the end of the tubing through the right post of the MicroTee, as viewed in Figure 9B, until the tubing and sleeve seat against the bottom ledge inside the post. Screw the nut finger-tight onto the MicroTee.
- 4) Insert the distal end of the PicoTip through a green MicroTight sleeve, then through the nut and the black ferrule, as shown in Figure 9C. Carefully trim the end of the PicoTip. Refer to the accompanying Technote FS-1 for proper method of cleaving fused silica. After trimming, insert the assembly back into the MicroTee, seat the PicoTip, ferrule, and sleeve against the transfer line, and finger-tighten the nut, as shown in Figure 9D. Gently pull on the tubing ends to ensure the connection is tight. Check for leaks by running solvent through the tubing at the expected operating pressure. Leaks will be apparent if solvent collects at the exposed ends of the sleeves.

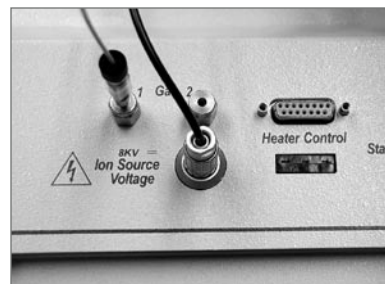

FIGURE 7



FIGURE 8



FIGURE 9A



FIGURE 9B



FIGURE 9C



FIGURE 9D

### Tuning Hints

- For initial setup and system parameter tuning (sheath gas flow, ESI voltage, emitter position), it is best to work with a well characterized standard. Delivery of a standard by continuous infusion is preferred, as this method provides sufficient time to optimize each parameter.
- Sheath gas is best used with the emitter mounted at an angle to the MS inlet.
- Use the minimal amount of sheath gas to achieve the desired effect. Too high a gas flow setting will reduce ion current, reducing sensitivity.
- Using sheath gas will change both the optimal emitter position and the ESI voltage. Optimal emitter location is usually farther from the MS inlet (typically 20-30% greater than the non-sheath set point).
- Optimal settings will be a function of mobile-phase flow rate. Higher mobile-phase flow rates will typically require more sheath gas and higher operating voltages.
- Optimal settings will also be a function of mobile-phase composition. For use with gradient chromatography, it is best to optimize conditions using a standard prepared in an average mobile-phase elutant, such as one prepared with 20% organic cosolvent.

PEEK is a trademark of Victrex plc. QSTAR is a registered trademark of Applied Biosystems, Inc. PicoTip, TaperTip, PicoTip Powered, and PicoFrit, are trademarks or registered trademarks of New Objective, Inc. All other trademarks are the property of their respective owners. The information contained in this circular is believed reliable and accurate; however, nothing set forth herein constitutes a warranty or representation of any kind or nature. ©2004 New Objective, Inc. All rights reserved.

## High Throughput Analytical Proteomics Using PicoFrit® Columns

Trypsin in gel digestion of proteins from a single band of a 1D SDS-PAGE can yield a very complex mixture of peptides. Depending on the starting material, these peptides can easily be present at trace levels near the detection limits of a mass spectrometer. This places an importance method sensitivity. The current accepted way to examine complex mixtures of peptides is through reversed phase chromatography with an HPLC linked to a mass spectrometer. A small internal diameter capillary column should be used in order to obtain the best sensitivity from a chromatography standpoint. A novel column called a PicoFrit® column (Figure 1) is currently commercially available with a 75 µm internal diameter. For the best chromatographic resolution a 10 cm packing filled of either BioBasic® or ProteoPep® should be used with a shallow gradient.

The optimal flow rate for a 75 µm PicoFrit column is between 200 and 300 nL/min. To obtain such low flows without a nano-LC, a flow splitter can be made using a zero dead volume Valco tee with several meters of fused-silica tubing on the waste side of the tee.

In order to achieve the maximum lifetime from a PicoFrit column, attention must be paid to the purity of the solvent used for the chromatography. The highest purity acetonitrile and HPLC grade, distilled in glass, water should be used. Filtered water has shown to cause problems. Micro fines of amorphous carbon particles can escape from the activated carbon cartridge and will rapidly clog a column. These particles are not filtered even by 0.2 µm filters. The 18 Mohms resistivity only means that there are a limited amount of ions within the water. Filtered water could contain as much as 100 µg/L of amorphous carbon leaching from the activated carbon cartridge. Mobile phases should be degassed by an ultrasonication for 20 min. Filtration should be avoided due to contaminating substances which can be extracted from membrane filters.

If the HPLC system has been contaminated with filtered water, it might take several weeks after switching to distilled water before getting rid of the contamination. However, until the system is decontaminated, a clogged column can be salvaged by cutting out the carbon plug under a microscope. The column can then be reconnected with a PTFE sleeve.

A clogged column can be diagnosed by observation of the HPLC backing pressure. After installing and conditioning the column, it is important to note the backpressure at the beginning of the gradient as well as the highest acetonitrile concentration and continue to verify that backpressure regularly. If the backpressure starts to rise, this could be due to the clogging of the column. If this is the case, the accumulated carbon can be easily seen through the polyimide coating of the column. Contaminated water can also be diagnosed by examining the sampling cone on the mass spectrometer. With clean water, the sampling cone should remain shiny for weeks. Conversely, if filtered water is

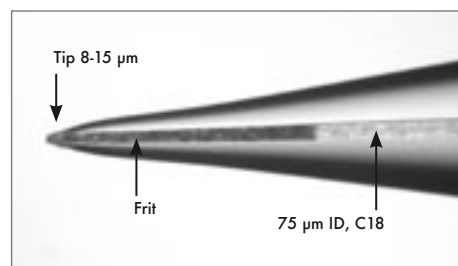

FIGURE 1 The PicoFrit® format incorporates a chromatographic column with a nanospray emitter. This combination tip eliminates band broadening associated with the dead volume normally between the column and the spraying tip.

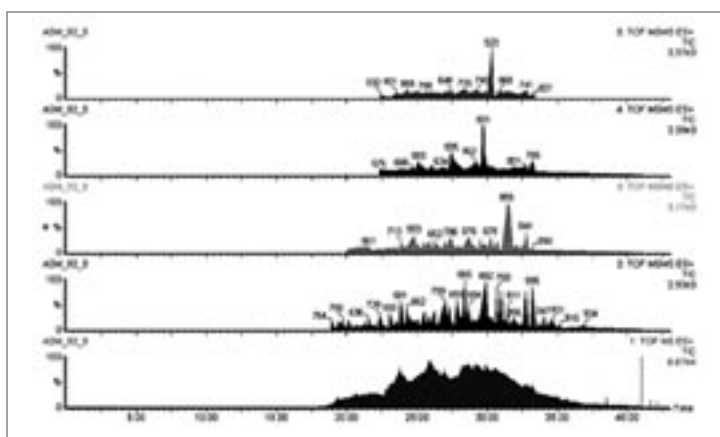

FIGURE 2 In gel digestion of the smooth endoplasmic reticulum on a PicoFrit® column after 928 injections

used, a brown substance will buildup rapidly on the cone surface. The brown material is composed of polyaromatic hydrocarbons (PAH) and other organic molecules desorbed from the carbon particles by the acetonitrile gradient.

After several months of continuous use, the column will stop spraying due to the erosion of the spraying tip. Continuous spraying along with high voltage will dull the sharp edges of the tip and impair the efficiency of the electrical field. The optimal spraying voltage will increase to a high potential and the column should be changed. Typically, in our lab it would take at least 2 months. If handled properly, a 75  $\mu\text{m}$  PicoFrit column can last for several hundred injections of in gel digest protein samples. The column presented here lasted for 1300 injections without losing good peak shape (Figure 2).

Provided by Daniel Boismenu  
Montréal Network for Pharmacoproteomics and Structural Genomics  
McGill University  
Montreal, Quebec, Canada

PicoTip, TaperTip, PicoTip Powered, PicoFrit, and PicoView are trademarks or registered trademarks of New Objective, Inc. BioBasic is a registered trademark of Thermo Electron Corporation. All other trademarks are the property of their respective owners. The information contained in this circular is believed reliable and accurate; however, nothing set forth herein constitutes a warranty or representation of any kind or nature. ©2004 New Objective, Inc. All rights reserved.

## Using PicoFrit® Columns With the Micromass® ZSpray™ Nanoflow™ Stage

New Objective's probe modification kit enables the use of PicoFrit® columns with your existing Micromass® ZSpray™ Nanoflow™ stage. Use of either self-pack or pre-packed PicoFrit columns is supported through a platinum wire electrode to establish pre-column, high-voltage contact. With their built-in emitters, PicoFrit columns allow you to avoid the tedious process of having to connect a nanobore column to an ESI tip, as well as eliminate clogged tips. The integral PicoTip® design assures you optimal chromatographic performance by eliminating post-column band broadening. You spray directly off of the end of the column and into your mass spectrometer.

### Contents of the ADPC-MZS kit:

- PicoFrit® stage adapter (base plate, MicroTee™ and union mounting blocks)
- MicroTee™ with platinum wire electrode
- MicroTight® union, fittings and sleeves
- New Objective's diamond scribe



FIGURE 1  
Assembled Adapter

**WARNING:** Electrospray ionization involves the use of potentially lethal, high-voltage electrical current. Observe all manufacturers' safety recommendations in the use of such equipment. No equipment modifications should be made except by trained personnel using methods approved by the manufacturer in accordance with all safety requirements. Installation of equipment should be performed by qualified personnel in accordance with all applicable electrical codes.

### Removing the spray manifold block from the Micromass ZSpray™ stage

As shown in Figures 2A-C, the ADPC-MZS replaces the spray manifold block provided by Micromass for your nanoflow stage. Before mounting the ADPC-MZS, please review the manufacturers' safety instructions for turning off all source voltages and selecting the proper standby mode.

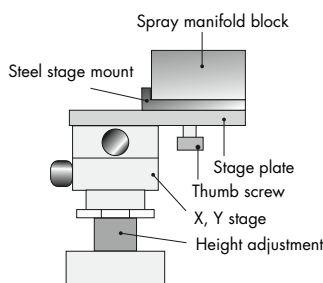

FIGURE 2A

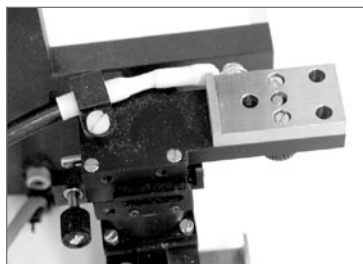

FIGURE 2B Remove spray manifold block

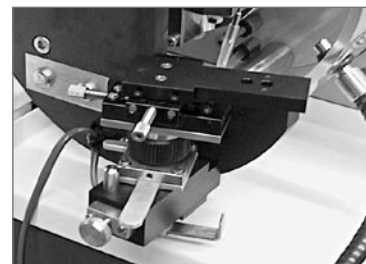

FIGURE 2C Remove steel stage mount and high-voltage lead

- 1) Put the system into Standby mode.
- 2) Rotate the stage into the Open position.
- 3) Remove all liquid and gas lines from the spray manifold block.
- 4) Loosen and remove the thumbscrew that holds the spray manifold block to the stage plate.
- 5) Using a precision screwdriver, loosen the two (2) 2 mm-thread screws from the top of the steel stage mount. You can then remove the steel stage mount from the top of the stage.
- 6) Disconnect the high-voltage lead from the side of the stage by loosening the mounting screw. The stage should now look like Figure 2C.

You are now ready to mount the ADPC-MZS base plate.

### Mounting the ADPC-MZS base plate

Mount the ADPC-MZS base plate on the stage plate as shown in Figure 3.

- 1) Line up the ADPC-MZS base plate with the top of the stage plate.
- 2) Insert the screws into the counter-bored holes at the front of the ADPC-MZS base plate.
- 3) Using the 1.5 mm Allen wrench provided, screw the two 2 mm screws into place to securely hold the ADPC-MZS base plate on top of the stage plate.

### Mounting the PicoFrit® Column on the ADPC-MZS base plate

- 1) Prepare the MicroTight® union as shown in Figure 4A by removing a fitting from one end. Slide the green MicroTight sleeve through the remaining fitting in the union as seen in Figure 4B. Tighten the fitting just enough to prevent unwanted movement of the sleeve. Replace the fitting on the other end of the union as in Figure 4C.
- 2) Place the union in the union mounting block as seen in Figure 4D. Tighten the set screw to hold the union firmly in place.
- 3) Remove the PicoFrit column from its protective packaging according to the directions that came with the column.
- 4) Slide the distal, or non-tip, end of the column through the sleeve protruding from the fitting and union assembly as in Figure 4E. Pull the column through the sleeve until the tip protrudes just a few millimeters from the sleeve as shown in Figure 4F. Tighten the fitting around the column until the column is no longer loose.
- 5) Place the union mounting block on the end of the ADPC-MZS base plate as in Figure 5.

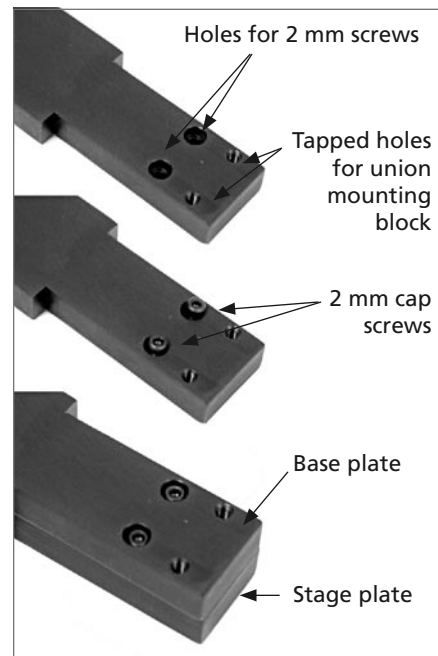

FIGURE 3 Mounting the ADPC-MZS plate onto the stage plate

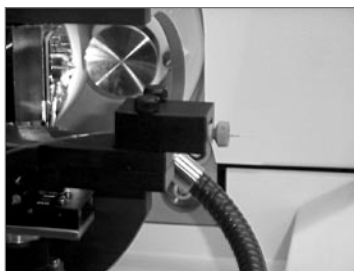

FIGURE 5 ADPC-MZS adapter mounted on nanoflow™ stage with a PicoFrit® column in place

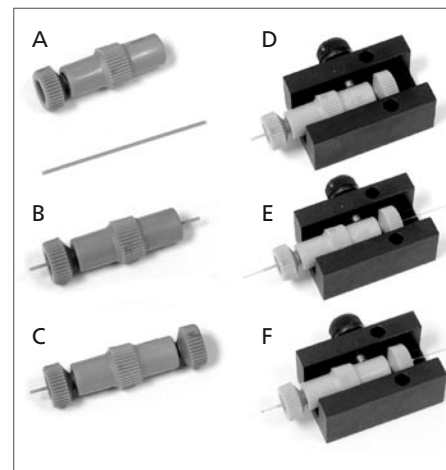

FIGURE 4(A-F) Placing the PicoFrit® column into the union and onto the union mounting block



**WARNING:** The transfer line that connects to the high-voltage MicroTee must be made of an electrically non-conductive material such as PEEK™ or fused silica. Do not use stainless steel, or any other electrically conductive material or risk of electrical shock is present. A proper electrical grounding point must also be supplied on the inlet side end of the transfer line. Do not attempt to modify, adjust, or remove any of the set screws of the MicroTee assembly.

### Connecting the PicoFrit® Column to the MicroTee

- 1) Verify that the high voltage is turned off.
- 2) Locate a green MicroTight® sleeve and MicroTee. Unscrew the ferrule and cap from the MicroTee as shown in Figure 5A.
- 3) Slide the distal, or non-tip, end of the column through the sleeve. Then slide the column and sleeve through the cap and ferrule as shown in Figure 5B. Using the diamond scribe and the cleaving technique described in Technical Note FS-1, trim the distal end of the column so that the overall length of the column is 15-17 cm.
- 4) Insert the column, sleeve, and ferrule into the forward port of the MicroTee. While pushing the column tubing and sleeve flush with the inlet port, tighten the nut fingertight. You should not be able to pull out the column tubing with a moderate pulling force. If you can, re-seat the tubing and apply greater torque to the nut.
- 5) Mount the MicroTee assembly to the ADPC-MZS base plate, as shown in Figure 5C, using the 4-40 x 1/2" thumb screw provided.
- 6) Connect a fused-silica transfer line (50 mm ID tubing is supplied) to the back port of the MicroTee by repeating Steps 2 - 4. Connect the transfer line to your sample injection and mobile-phase delivery system through an electrical ground. Consult your manufacturer's literature to locate an appropriate grounding point. The pumping system should be capable of delivering flow rates in the range of 100-500 nL/min for optimal PicoFrit performance.

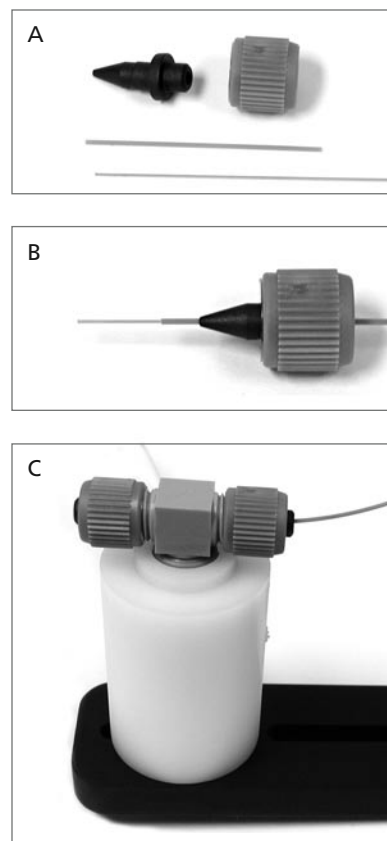

FIGURE 5 (A) Ferrule, cap, and sleeve ready for assembly with a PicoFrit® column or transfer line tubing (B) Ferrule in cap loaded with sleeve and column/transfer line tubing (C) PicoFrit column connected to the forward port of the MicroTee, mounted on the ADPC-MZS base plate

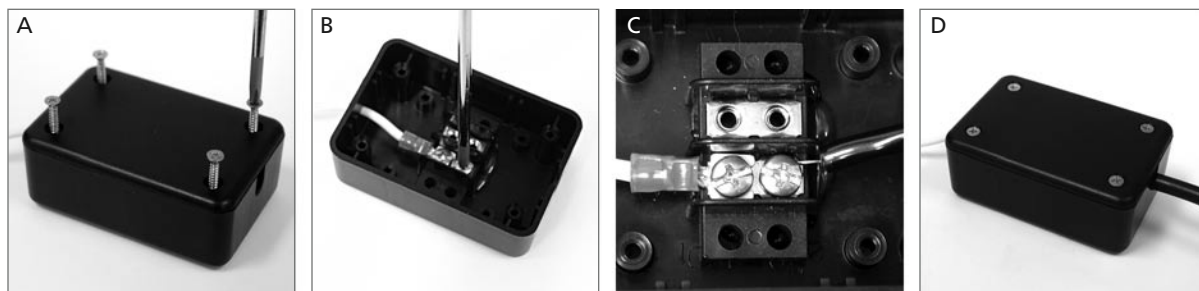

FIGURE 6 Connecting the high-voltage cable

### Connecting the high-voltage lead to the junction box

- 1) Verify that the high voltage is turned off. Remove the four screws that hold the junction box lid in place, as shown in Figure 6A, and remove the junction box lid.
- 2) Loosen the unused screw on the terminal strip as shown in Figure 6B.
- 3) Place the cable high-voltage lead around the screw as in Figure 6C. You may have to gently bend and reshape the lead for a good fit under the head of the screw. (Do not over-bend as you may fatigue and break the lead.) Tighten the screw for a good fit.
- 4) Verify the tightness of the lead, replace the junction box lid, and all four cover screws as in Figure 6D.
- 5) You may use the hook-and-loop fastener provided to temporarily mount the junction box to the instrument. Mount the box in a position that will prevent unwanted tugging or pulling on the Micromass high-voltage cable. Route the adapter's high-voltage cable in a safe manner that will prevent damage to the cable insulation.

### PicoFrit® Tuning Hints

Applied voltage is perhaps the most important parameter for stable, efficient operation.

NOTE: To prevent an arc or corona discharge never use a “turn-on” voltage above 500 V unless stable ESI has been previously established.

It is best to start tuning at a low voltage, under 1 kV, and increase the operating potential in 100 V increments until stable operation is achieved.

In low-flow ESI, it is important to recognize the interdependence of flow rate and the applied electric field. For a given tip size, stable ESI can occur over a wide range of flow rates but only over a narrow range of field strength (50 V or less). Raising the flow rate requires a higher field strength, and vice versa.

Best results are usually obtained by observing the magnified image of the spray pattern and tuning for an even ESI plume of droplets, as shown in Figure 7, rather than a directed linear stream.

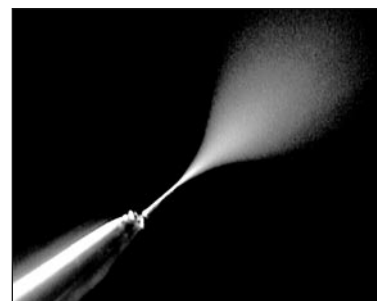

FIGURE 7 Stable ESI plume

PicoTip, TaperTip, PicoTip Powered, PicoFrit, and PicoView are trademarks or registered trademarks of New Objective, Inc. All other trademarks are the property of their respective owners. The information contained in this circular is believed reliable and accurate; however, nothing set forth herein constitutes a warranty or representation of any kind or nature. ©2004 New Objective, Inc. All rights reserved.

## Nanobore Gradient LC/MS and MS/MS Using POROS®-Packed PicoFrit® Columns for Femtomole Sensitivity Peptide Analysis

### Introduction

With their low back-pressure, high-porosity frits, PicoFrit® emitters for electrospray ionization (ESI) allow packing of reverse-phase HPLC particulate media. Figure 1 shows unpacked and packed PicoFrit emitters. Post-column band spreading or losses are eliminated in this integral LC column/ESI emitter approach. The only post-column plumbing is the mass spectrometer itself. The highest sensitivities reported for LC-MS utilize this sheathless interface approach.<sup>1,2</sup> PicoFrits are ideal for femtomole (10–15 mol) sensitivity peptide/proteomics analysis.

### Column fabrication

Washed and decanted to remove fine particles, 10 µm POROS® R2 media was prepared in filtered MeOH as a dilute slurry. Fused-silica tubing (360 µm OD x 75 µm ID x 50 cm, with an integral 15 µm tapered and fritted tip (New Objective part number PF360-75-15-N)) was pressure packed at 400 psi using a capillary packing bomb.<sup>3</sup> The system was pressurized for approximately five minutes, resulting in an approximately 10 cm packed column. Packing uniformity was monitored by light microscopy.

### Column installation

The packed PicoFrit® column was connected to a gradient HPLC pumping system modified for sub-microliter per minute flow rates with the use of an electrically grounded, pre-column T flow-splitter.<sup>3</sup> Samples were injected on-column by disconnecting the column from the pump line and inserting it into a head-space pressurization bomb similar to that used for packing.<sup>3</sup> The tip end of the PicoFrit column was mounted in close proximity (less than 0.5 mm) to the inlet orifice of an ion-trap mass spectrometer (Thermo Finnigan LCQ™ Classic) using a custom-built stage. The required ESI high-voltage contact (1–3 kV) was established at the head of the column by a platinum wire through the arm of a second PEEK™ tee. This second tee also served as the column coupling point to the filtered outlet of the flow-splitter.

Chromatography was performed at a nominal column flow rate of 215 nL/min. A gradient of water to acetonitrile (both 0.05 M HOAc) was run at 2% B/min (B = acetonitrile/0.05 M HOAc). Peptides of interest eluted in the range of 20–40% B. Columns were washed with a high percentage of B (more than 50%) between injections.

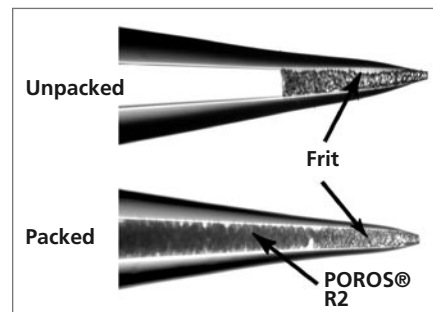

FIGURE 1 PicoFrit® columns, unpacked and packed with media

20 fmol/peptide  
200 nL inj. @ 100 fmol/µL/peptide  
215 nL/min, 2% B/min gradient  
in 10 cm x 75 µm column  
3.18E7 Base peak  
Full ms:[395-1300]

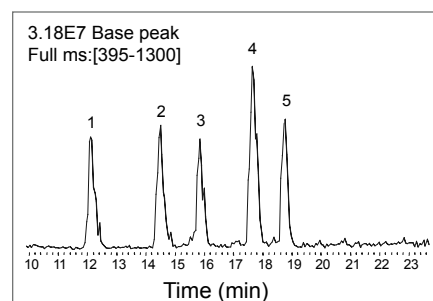
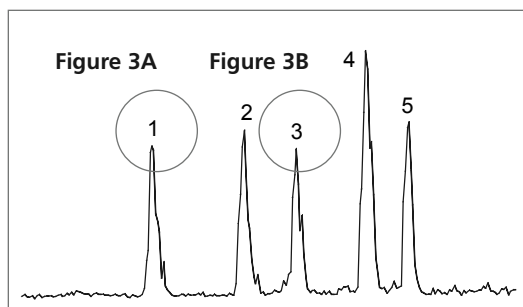

FIGURE 2 Base-peak ion chromatogram (A = water, B = acetonitrile; 50 mM HOAc) of five angiotensin peptides at 20 femtomole per peptide

## Results

Figure 2 and Figure 3 show a base-peak ion chromatogram and representative MS and MS/MS spectra of a test mixture of five different angiotensin type I, II, and III peptides (Sigma-Aldrich Corporation). Two hundred nL of the 100 fmol/ $\mu$ L/peptide mixture yielded a total of 20 fmol/peptide available for analysis. Note the excellent peak symmetry and reasonable peak width (12–16 s FWHM), even though this low flow rate is below the “perfusion” regime desired for high-performance separations from POROS® media.<sup>4</sup>



Data courtesy of William S. Lane and Daniel P. Kirby, Harvard Microchemistry Facility, Cambridge, Mass.

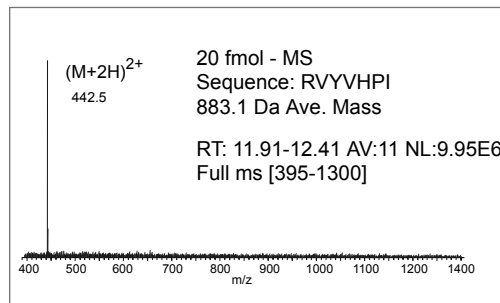

Figure 3A High-quality, full-scan MS spectrum of peak #1, with no other peptides or contaminants observed

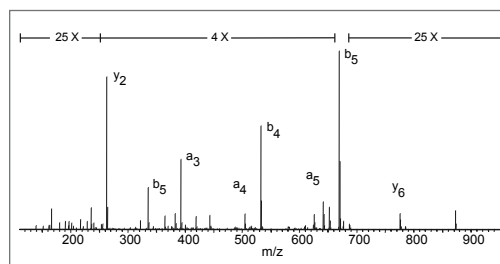

Figure 3B Good chromatographic resolution permits full-scan MS/MS of peak #3 with straightforward interpretation. Such data provides sufficient sequence information ( $y$  = C terminus ions;  $a$ ,  $b$  = N terminus ions) for peptide and, in many cases, subsequent protein identification.<sup>5</sup> Scale expansion factors are denoted at the top of the figure.

## References

1. M. R. Emmett and R. M. Caprioli, *Journal of the American Society for Mass Spectrometry* 5 (1994): 605.
2. P. E. Andren, M. R. Emmett, and R. M. Caprioli, *Journal of the American Society for Mass Spectrometry* 5 (1994): 867.
3. K. B. Tomer, M. A. Moseley, L. J. Deterding, and C. E. Parker, *Mass Spectrometry Reviews* 13 (1994): 431.
4. N. Afeyan et al. *Journal of Chromatography A* 519 (1990): 1.
5. S. D. Patterson and R. Aebersold, *Electrophoresis* 16 (1995): 1791.

The information contained in this circular is believed reliable and accurate; however, nothing set forth herein constitutes a warranty or representation of any kind or nature. CAUTION: Particular end-user applications for these products may be restricted by existing patents. Complying with any such patent is the sole responsibility of the user. POROS is a registered trademark of Applied Biosystems. LQG is a trademark of the Thermo Finnigan Corporation. PEEK is a trademark of Victrex plc. PicoFrit and PicoTip Powered are registered trademarks of New Objective, Inc. PicoFrit columns are manufactured under U.S. Patents 5,997,746 and 6,190,559 and are sold under license of U.S. Patent 5,572,023. New Objective reserves the right to change product specifications without notice. ©2004 New Objective, Inc.

### nLC/ESI-Mass Spectrometry

LC-ESI columns were mounted on a LCQ™ ion-trap mass spectrometer (Thermo Finnigan Inc.) using an inline tip adapter, model ADPT-TLC (New Objective, Inc.) shown in Figure 4. High-voltage (1-3 kV) contact was established with the coated end of the needle using a spring contact mechanism. The distal end of the column was attached to a modified PEEK™ union (Upchurch Scientific). The other end of the union was fitted with a tubing sleeve that provided for rapid push-on coupling to a variety of stainless-steel needles on gas-tight syringes (SGE Inc.). On-column sample injection, washing, and elution were performed by manually swapping syringes. Injection was performed by hand, while solvent flow for washing and elution (0.2 to 1 ml/min) utilized the LCQ syringe pump. MS/MS data was acquired in a data-dependent manner. A test sample consisting of a mixture of six synthetic class I kb murine peptides (7 to 8 bases long, covering a mass range of 881 to 992 Da) was prepared in 1% acetic acid, final concentrations ranging from 7.9 to 16.5 fmol/ml per peptide.



FIGURE 4 ADPT-TLC on the Thermo Finnigan LCQ™

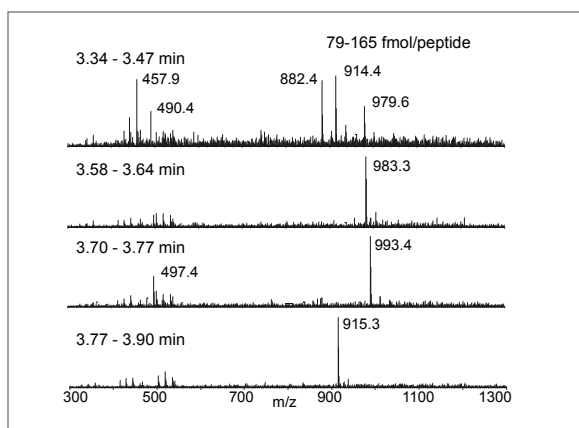

FIGURE 5 MS Results

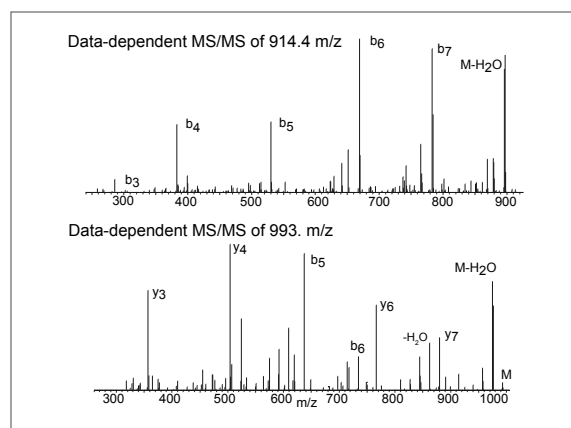

FIGURE 6 MS/MS Results

### MS/MS Results Acknowledgments

For the LCQ™ data: Andrew J. Tomlinson and Roman M. Chiczy, Pangaea Pharmaceuticals, Lexington, MA. For supplying the synthetic peptide samples: Steve Jameson and Chad Kieper, Center for Immunology, University of Minnesota Medical School.

### References

- 1) M. R. Emmett and R. M. Caprioli. "Micro-Electrospray Mass Spectrometry: Ultra-High-Sensitivity Analysis of Peptides and Proteins," *J. Am. Soc. Mass Spectrom.* 1994, 5, 605-613
- 2) M. T. Davis, D. C. Stahl, S. A. Hefta, T. D. Lee. "A Microscale Electrospray Interface for On-Line Capillary Liquid Chromatography/Tandem Mass Spectrometry of Complex Peptide Mixtures." *Anal. Chem.* 1995, 67, 4549-4556

The information contained in this circular is believed reliable and accurate; however, nothing set forth herein constitutes a warranty or representation of any kind or nature. Caution: Particular end-user applications for these products may be restricted by existing patents. Complying with any such patent is the sole responsibility of the user. PicoFrit is a registered trademark of New Objective, Inc. POROS is a registered trademark of Applied Biosystems. LCQ is a trademark of the Thermo Electron Corporation. PEEK is a trademark of Victrex plc. New Objective, Inc. reserves the right to change specifications of its products without notice. PicoFrit columns are manufactured under U.S. Patents 5,997,746 and 6,190,559 and sold under license of U.S. Patent 5,572,023. © 2004 New Objective, Inc. All rights reserved.