

Operating manual for micro annular gear pumps  
**mzr-4622**



HNP Mikrosysteme GmbH  
Bleicherufer 25  
D-19053 Schwerin (Germany)  
Telephone: +49 385/52190-301  
Telefax: +49 385/52190-333  
E-mail: [info@hnp-mikrosysteme.de](mailto:info@hnp-mikrosysteme.de)  
<http://www.hnp-mikrosysteme.de>

Last update: February 2015

## **Impressum**

Original instructions

Copyright

HNP Mikrosysteme GmbH  
Bleicherufer 25  
D-19053 Schwerin

All rights, including translation, reserved.

Without prior explicit written permission of HNP Mikrosysteme GmbH no part of this manual may be, copied, reproduced or processed.

This manual has been prepared with care. HNP Mikrosysteme does assume no liability for any errors in this manual and resulting consequences. Likewise, no liability is assumed direct or subsequent damages arising from an incorrect use of the devices.

While using micro annular gear pumps, the relevant standards regarding the specifications of this manual have to be followed.

Subject to change without notice.

# Contents

<b>1</b>	<b>General Information</b>	<b>1</b>
1.1	Application scope of the pumps	1
1.2	Product information	2
1.3	Measurements	2
1.4	Flow chart mzr-4622	3
1.5	Technical data of the micro annular gear pump mzr-4622	4
1.6	Technical data of the drive	5
<b>2</b>	<b>Safety instructions</b>	<b>7</b>
2.1	Safety symbols in this operating manual	7
2.2	Staff qualification and training	7
2.3	Safety-conscious work	7
2.4	Safety instructions for the operator	8
2.5	Safety instructions for maintenance, check and assembly of the pump	8
2.6	Unauthorized pump conversions and spare part manufacture	8
2.7	Improper modes of operation	9
2.8	General safety instructions	9
<b>3</b>	<b>Transport and intermediate storage</b>	<b>10</b>
3.1	Shipment of the pumps and protection measures	10
3.2	Transport	10
3.3	Intermediate storage	10
<b>4</b>	<b>Description of the pump</b>	<b>11</b>
4.1	Principle of the Micro annular gear pumps	11
4.2	Micro annular gear pump mzr-4622	13
4.3	Materials and liquids	14
4.4	Liquid supply	14
<b>5</b>	<b>Optional modules</b>	<b>16</b>
5.1	Gear box module (optional)	17
5.2	By-pass module (optional)	18
5.3	Drive with a high resolution encoder (optional)	20
5.4	Drive with high torque (optional)	21
5.5	Brushless DC motor as drive (option)	23
5.6	Drive without encoder (optional)	24
<b>6</b>	<b>System integration</b>	<b>25</b>
6.1	Checkup before the first assembly	25
6.2	Mounting of the micro annular gear pump	25
6.3	General instructions for the assembly of the liquid supply network	26
6.3.1	Assembly of the fluid connection fittings	26

6.3.2	Installation with the manifold assembly	26
6.3.3	Assembly instruction for tubing and accessories manifold assembly	27
6.4	Filter selection and use	28
6.5	Operation with the S-ND control unit	29
6.6	Operation with the S-KD control unit (optional)	32
6.7	Operation with controller S-KG control unit (optional)	36
<b>7</b>	<b>Start Up / Shut Down</b>	<b>40</b>
7.1	Preparing for operation	40
7.2	Startup of the micro annular gear pump	40
7.3	Flushing procedure after use	40
7.4	Shutdown of the micro annular gear pump	43
7.4.1	Conservation	45
7.4.2	Dismantling of the system	46
7.5	Problem shooting	47
7.6	Return of the micro annular gear pump to the manufacturer	47
<b>8</b>	<b>Software »mzs-pump control«</b>	<b>48</b>
<b>9</b>	<b>»Motion Manager« software (optional)</b>	<b>51</b>
9.1	Direct drive control	51
9.2	Programming of the control unit	53
9.3	Transfer of a mcl-file to the drive	53
<b>10</b>	<b>Accessories for microfluidic systems</b>	<b>60</b>
<b>11</b>	<b>Non-liability clause</b>	<b>60</b>
<b>12</b>	<b>Problem shooting</b>	<b>61</b>
<b>13</b>	<b>EC Directive</b>	<b>64</b>
13.1	Electromagnetic Compatibility (EMC)	65
13.1.1	EMC Directive and Standards	65
13.1.2	Information on use as intended	66
<b>14</b>	<b>Declaration of conformity</b>	<b>67</b>
<b>15</b>	<b>Service, maintenance and warranty</b>	<b>73</b>
<b>16</b>	<b>Contact person</b>	<b>74</b>
<b>17</b>	<b>Legal information</b>	<b>75</b>
<b>18</b>	<b>Safety information for the return of already employed micro annular gear pumps and components</b>	<b>76</b>
18.1	General information	76

18.2	Declaration of media in contact with the micro annular gear pump	76
18.3	Shipment	76
<b>19</b>	<b>Declaration of media in contact with the micro annular gear pump and its components</b>	<b>77</b>
<b>20</b>	<b>Appendix</b>	<b>78</b>



# 1 General Information

This operation manual contains basic instructions to be followed during integration, operation and maintenance of the mzr® micro annular gear pump. For this reason it is necessary to read it carefully before any handling of the device. The present manual should always be kept at the operation site of the micro annular gear pump.

In case assistance is needed, please indicate the pump type visible on the housing.

## 1.1 Application scope of the pumps

The micro annular gear pump mzr-4622 described in this manual are suitable for continuous delivery and discrete dosage of water, watery solutions, solvents, methanol, oils, lubricating liquids, paints and varnishes as well as many other liquids.



If you intend to handle any aggressive, poisonous or radioactive liquids, you must conform to safety measures as according to the regulations in force. Any project concerning handling of corrosive liquids should be previously discussed with the pump manufacturer.



The micro annular gear pumps should not be used for "invasive" medical applications, in which the liquid having had contact with the pump is re-introduced to the body.



Micro annular gear pumps exclusively are provided for use in the industrial area. A private use is excluded.



The micro annular gear pumps must not be used in aircrafts and spacecrafts or other vehicles without prior consent of the manufacturer.



The data concerning resistance of the pumps to manipulated liquids is elaborated according to the best of HNP Mikrosysteme's knowledge. However, operating parameters varying from one application case to another, no warranty for this information can be given.



The information given in this manual does not release the customer from personal obligation to check the integrity, correct choice and suitability of the pump for the intended use. The use of the micro annular gear pumps should be conform with technical norms and regulations in force.

If you wish to receive more information than comprised in this manual please contact directly HNP Mikrosysteme.

### 1.2 Product information

This manual is valid for the micro annular gear pumps mzs-4622 manufactured by HNP Mikrosysteme GmbH, Bleicherufer 25, D-19053 Schwerin, Germany. The bottom line of this manual shows issue and date of issue of the manual.

### 1.3 Measurements

The pump is available in two versions featuring different liquid connectors. figure 1 shows the version with  $\varnothing 2$  mm slip fittings on which flexible tubes with internal diameter  $< 2$  mm are stuck. figure 2 shows the version with a manifold assembly, which is screwed and fixed with a holding nut to a preadapted support.

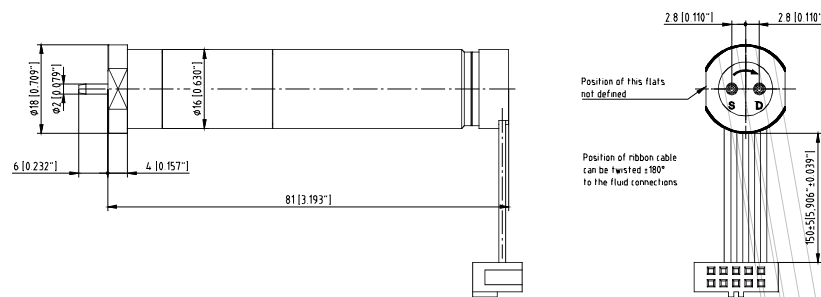

figure 1 Measurement in configuration slip fittings OD 2 mm

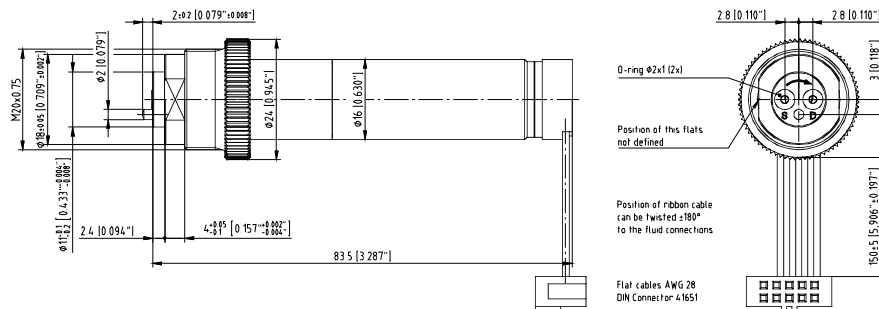

figure 2 Measurement in configuration manifold assembly



### 1.4 Flow chart mzs-4622

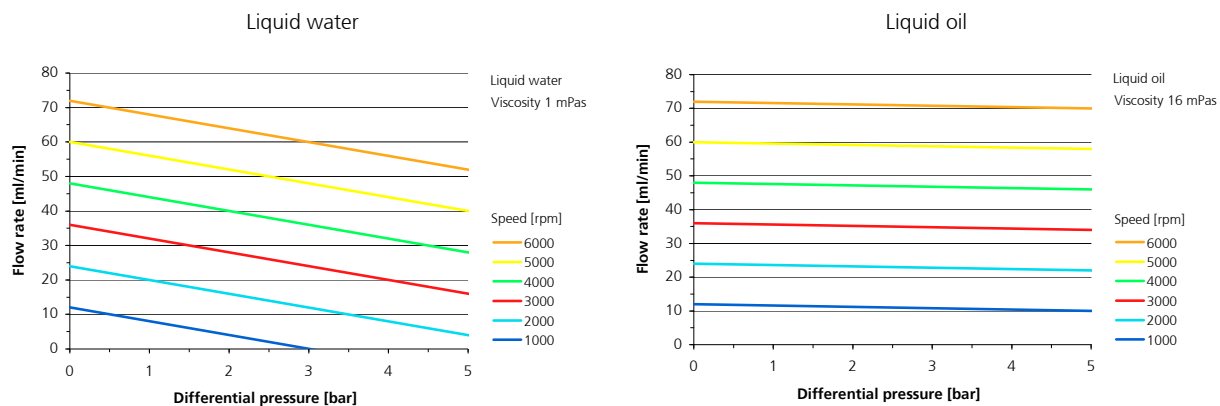

figure 3 Flow charts mzs-4622

## 1.5 Technical data of the micro annular gear pump mZR-4622

<b>mZR-4622</b>	
<b>Technical data</b>	
Displacement volume	12 µl
Housing length without fluid connections	89 mm
Housing length with fluid connections	
– slip fitting version Ø 2 mm	86 mm
– manifold assembly version	83,5 mm
Diameter	13 mm
Weight	
– slip fitting version Ø 2 mm	100 g
– manifold assembly version	100 g
Internal volume	85 µl
Housing material	stainless steel 316L (1.4404), epoxy resin adhesive
Fluid connector material	stainless steel 316L (1.4404)
Rotor material	tungsten carbide (WC-Ni)
Bearing material	tungsten carbide (WC-Ni) / ceramics
Dynamic sealing	graphite-reinforced PTFE, stainless steel spring 316L
Static sealing	FKM; optional EPDM, FFKM
<b>Performance parameters</b>	
Min. flow rate Q (at 1 rpm)	0.012 ml/min*
Max. flow rate Q (at 6000 rpm)	72 ml/min
Min. dosage volume	2 µl
Differential pressure (at viscosity 1 mPas)	0 – 5 bar (73 psi)
Max. applied inlet pressure	1 bar (15 psi)
Viscosity	0.3 – 100 mPas (1000 mPas*)
Dosage precision CV	1 %
Liquid temperature	-20 ... 60 °C
Ambient temperature	-20 ... 65 °C
Storage temperature	5 ... 40 °C
Pulsation of flow (theoretical value)	6 %
NPSHR value	0.5 m

\*) Values are specified for oil with viscosity 16 mPas. Differing specifications on request

\*\*) Customized solutions on request.

table 1

Technical data of the micro annular gear pump mZR-4622

### Warning

The material properties of a liquid (e.g. viscosity, lubricating property, particle content, corrosiveness) impacts the technical data and the lifetime of pumps. Under appropriate conditions the characteristic values may be increased or decreased.

### Warning

If you intend to operate the pump out of the range of the above given specification, please consult the manufacturer. Modifications may be necessary to ensure successful operation. Otherwise the pump or the system may be damaged seriously.

## 1.6 Technical data of the drive

The micro annular gear pump mzr-4622 is provided with an actuator equipped with a DC-motor. The DC motor uses a high dynamic and is recommended for programmed dosage operation of the micro annular gear pump. With an control unit it is possible to manage lower RPM ranges down to 10 RPM. The accuracy of dosage can be achieved better than 0.5 %. The connection of the motor to a control unit is simple.

### Motor:

Dimensions	
diameter	16 mm
length	43 mm
Data of capacity	
Max. voltage	24 V
Max. permanent torque	4,42 mNm
output power	4,5 W
No-Load speed by 18 V	13200 U/min
No-Load speed by 8,5 V	6000 U/min
max. permanent current	294 mA
Terminal resistor	11,2 $\Omega$
Rotor inductance	0,452 mH
RPM speed range	1 – 6.000 U/min
Temperature range	-20 ÷ +65 °C

table 2 Technical data of the motor

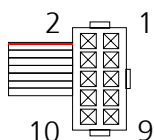

figure 4 Pin configuration of the motor cable

Pin	Description
1	Motor +
2	Vcc (5 VDC)
3	Channel A
4	Channel B
5	SGND
6	Motor -
7	Channel I

table 3 Pin configuration of the motor

<b>Encoder</b>	
Max. voltage	2,5 – 5,5 VDC
Count of channel A, B	2
cycles per revolution and channel	32
signal by $V_{cc} = 5$ VDC	TTL compatible
Supply current	max.5 mA
phase	90°
Temperature range	-20 ÷ + 80°C

table 4

Technical data of the Encoder

## 2 Safety instructions

Please comply not only with the general safety instructions listed below, but also with specific safety instructions mentioned in the following chapters.

### 2.1 Safety symbols in this operating manual

Non respect of the safety instructions marked with the following signs represents danger to *people*:

Danger symbol



Safety symbol according to  
DIN 4844 – W9

High voltage symbol



Safety symbol according to  
DIN 4844 – W8

Non compliance with the safety instructions marked with the following sign represents a risk of damage to the *micro annular gear pump*:

Warning

Operating instructions machined directly on the pump such as the indication of liquid input and output should be followed and kept in a clearly readable condition.

### 2.2 Staff qualification and training

The staff operating, servicing, inspecting and assembling the pumps must evidence the appropriate qualification for these works. Areas of responsibility and competence as well as monitoring of the staff must be precisely regulated by the operator in charge. If the personnel do not have the necessary knowledge, they must be trained and instructed accordingly. If necessary, this can be implemented by the supplier or the manufacturer on behalf of the operator. Furthermore, the operator in charge must ensure that the content of the present manual has been fully understood by the personnel.

### 2.3 Safety-conscious work

The safety instructions listed in this operating manual, applicable national regulations concerning accident prevention as well as internal work, operation and safety regulations of the operator must be complied with.

## 2.4 Safety instructions for the operator

The surface temperature of the motor under full load may exceed 60°C. If needed, this surface should be protected on site against contact in order to avoid skin burns.

The drive should be protected against dust, water vapor condensation, humidity, splash water, aggressive gases and liquids. Please provide for an adequate air ventilation and thus cooling of the motor.

The micro annular gear pump mZR-4622 must not be used in areas exposed to explosion risks or in proximity of inflammable gases and vapors.

Possible leaks of dangerous liquids (for example from the shaft sealing) should be guided away in a way not to represent any danger for the personnel and the environment. The pump should be regularly checked for possible leakage. All legal requirements in this matter should be complied with.

Take care that all risks resulting from the electric energy are excluded. For details please refer to the instructions provided by the authorities in charge or your power supplier.

### Warning

Please insure, that the totality of the liquid supply system such as tubes, hoses, filters etc. are free from dust or dirt particles. Impurities such as metal swarf, plastic or glass splinters may impair or damage the pump leading to its failure.

### Warning

Please, operate the pump with a filter featuring 10 µm or smaller pores. It will protect the pump.

## 2.5 Safety instructions for maintenance, check and assembly of the pump

As a rule all maintenance work on the device should be performed when it is at a standstill. The turning-off procedure described in this manual must be followed. Pumps delivering liquids hazardous to health must be decontaminated. Immediately after the work had been completed all safety equipment and protection measures should be applied.

Before starting the operation, please take notice of the instructions listed in the chapter 7.

### Warning

Should a malfunction of the mZR-pump occur, do not dismantle the pump on your own but contact one of HNP Mikrosysteme service staff for professional assistance.

## 2.6 Unauthorized pump conversions and spare part manufacture

Conversions or modification to the device are only permitted with prior consent of the manufacturer. Original spare parts and accessories authorized by the manufacturer ensure safety. The use of other parts will annul the liability of the pump manufacturer for any resulting consequences.

## 2.7 Improper modes of operation

The safety of operation of the delivered device can only be insured by correct use, as described in chapter 1. The limit values given in this manual must not be exceeded in any case.

## 2.8 General safety instructions

Please observe the following safety instructions



The pump may operate at high pressures. For this reason please use only the delivered accessories and ensure that the employed fittings and tubing have been prescribed and approved for these pressures.



In order to decrease the pressure, provide the system with a *pressure control valve* directing the excess liquid to the storage tank or back to the suction side. In the case of blockage of the pressure side the operating pressure can multiply, this can lead to the damage of downstream components.



At a standstill, the liquid may flow through the pump in the direction of falling pressure. In order to avoid this unwanted movement, please integrate non-return valves (see accessories). This applies also to elevated liquid containers.



Protect the micro annular gear pump and the electric drive against strokes and shocks.



Under normal working conditions the shaft sealing rings integrated in the pump prevent the liquid from leaking out of the device. The micro annual gear pumps are "technically leak-proof" however not "hermetically sealed" which means it may occur that gases or liquids enter to or escape from the pump.



The allowed electrical parameters of the drive must not be exceeded. In particular an incorrect polarity setting of the supply voltage may lead to damage of the control unit.

Warning

Please insure, that the totality of the liquid supply accessories such as tubes, hoses, filters etc. are absolutely free from dust or dirt particles. Impurities such as metal swarf, plastic or glass splinters may impair or damage the pump leading to its failure.

Warning

Please, operate the pump with a filter featuring 10 µm or smaller pores. It will protect the pump.

## 3 Transport and intermediate storage

### 3.1 Shipment of the pumps and protection measures

The pumps leaving the factory are secured against corrosion and shocks. The inlets and outlets of the pumps are protected with plastic plugs in order to prevent any foreign bodies from penetrating into the device.

### 3.2 Transport

In order to avoid any transport-related damage, the package must be protected against shocks. HNP Mikrosysteme guarantees that all goods leave the factory in the best condition. Any noticed damage should be reported to the concerned forwarding agent, authorized dealer or to HNP Mikrosysteme as manufacturer.

### 3.3 Intermediate storage

Following points concerning pump storage should be observed:

- necessary conservation procedure (see also chapter 7.4.1)
- the protective caps must be put on
- the pump should not be stored in humid places
- for storage temperature - refer to chapter 1.5 of the present manual



## 4 Description of the pump

### 4.1 Principle of the Micro annular gear pumps

Micro annular gear pumps are positive displacement pumps. They contain two rotors bearing slightly eccentrically to each other; an externally toothed internal rotor and an annular, internally toothed external rotor (see figure 5). Due to their cycloid indenting, the rotors remain interlocked at any time, forming during rotation a system of several sealed pumping chambers. As the rotors revolve around their offset axis, the pumping chambers increase on the induction (suction) side and simultaneously decrease on the delivery side of the pump (see figure 6). A homogenous flow is generated between the kidney-like inlet and outlet.

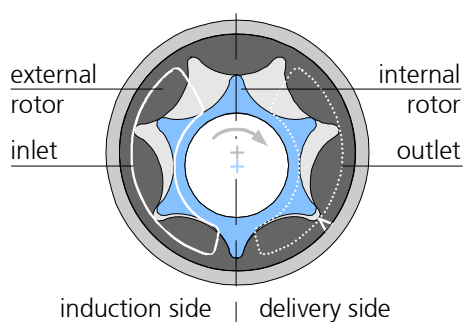

figure 5

Principle of the micro annular gear pump

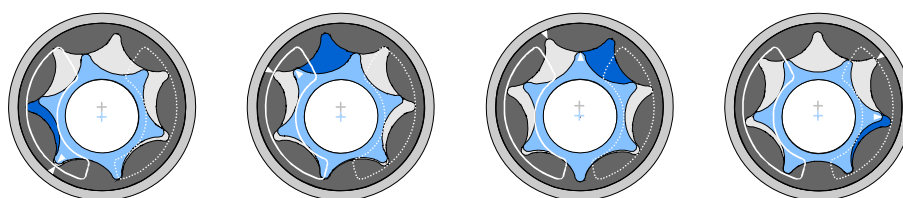

figure 6

Operating principle of the micro annular gear pump

Reciprocating and rotary pumps have a direct allocation to the fed amount of the displacement volume  $V_g$  of the pump and its actuator's number of revolutions  $n$ . The displacement volume describes the volume, which is theoretically fed with each revolution. The coherence of the flow rate referring to the formula (= volumetric flow rate)  $Q$  of the pump is:

$$Q = \eta_{Vol} \cdot V_g \cdot n$$

The volumetric efficiency  $\eta_{Vol}$  describes the coherence of the actual flow rate from the theoretical resulting value. Differences occur according to leaking, as the sealing on the inside of the pump is done over a gap. The volumetric

efficiency is dependent on the media and the pressure against which it has to be fed.

*Example:* The pump mzr-4622 feeds with its displacement volume of 12  $\mu\text{l}$  with 3000 RPM and a volumetric efficiency of 100 % referring to the above-mentioned formula the flow rate of 36 ml/min. The following table shows the volumetric displacement in dependence to the number of revolutions ( $\eta_{Vol} = 100 \%$ ).

RPM	Q [ml/min]	Q [ml/h]
100	1,2	72
500	6	360
1000	12	720
2000	24	1440
3000	36	2160
4000	48	2880
5000	60	3600
6000	72	4320

table 5

Theoretical flow rate of the micro annular gear pump mzr-4622

The pressure, which the pump has to generate, is given by the construction of the fluidic system and the results of the hydrostatic pressure and the hydraulic resistants (given by tubes, contractions etc.).

The viscosity of the pumping liquid has an important influence on the volumetric efficiency. The volumetric efficiency increases with higher viscosity according to the smaller disengagement through the gaps of the pump.

Cavitation is an effect, which can reduce the volumetric efficiency from in a specific ceiling speed. With increasing viscosity (e.g. > 5.000 mPas), this ceiling speed is lower. This is the result of the media specified underflow of the steam pressure in the induction port of the pump, in which gases are building up in the pump.

The specific feature of the mzr-pumps is their highly precise design, as well as the guarantee of high accumulator pressure and high accuracy in flow rate and dosage. Therefore, space width and transverse space width of the rotors as well as the interspace to the adjacent case parts lie in the range of just a few micrometers. This precision is at the same time the criteria to achieve a volumetric efficiency in the range of approx. 100 %.

The micro annular gear pump head has an inscription on the front side (see figure 7). The induction connection is marked with the letter »S«, the pressure connection with the letter »D«. An arrow on the front side of the pump indicates the inherent turning direction of the shaft.

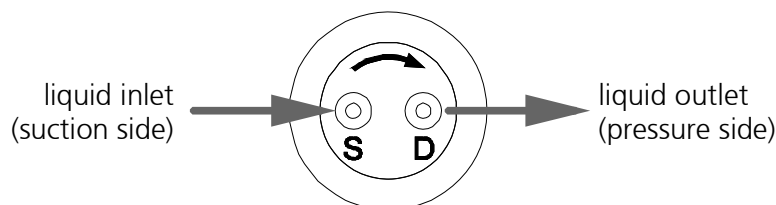

figure 7 Indication of the turning direction and fluidic connections on the front of the micro annular gear pump

## 4.2 Micro annular gear pump m zr-4622

The micro annular gear pump m zr-4622 is provided with an actuator equipped with an DC-motor. The DC motor works high dynamically and is recommended for programmed dosage operation of the micro annular gear pump. With this control unit it is possible to manage lower RPM ranges down to 100 RPM. The accuracy of dosage can be achieved better than 0.5 %. For operating, it is recommended to use a power source of 24 V (with a power rating of 2,5 A).

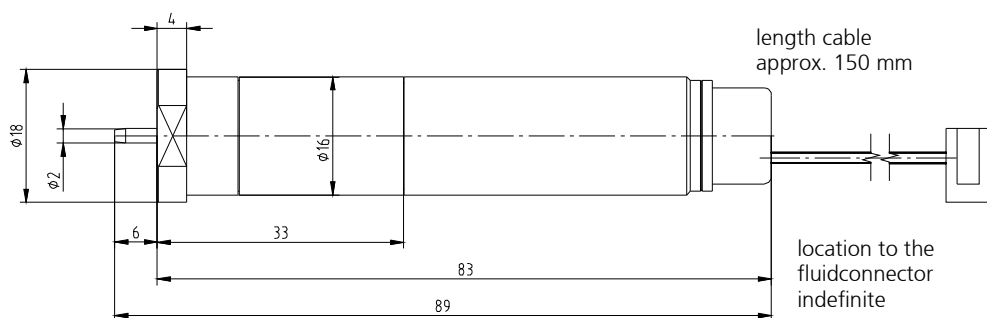

figure 8 Measures of the micro annular gear pump m zr-4622

The m zr-micro annular gear pump consists of the micro annular gear pump head, the coupling unit and an actuator. The pump head is equipped with two fluidic connector bore holes and a shaft for actuation of the rotors. The coupling unit serves as connection between the pump head and the actuator as well as to mount the micro annular gear pump.

The actuators used may be protected against dust, condensing moisture, humidity, splashing, aggressive gases and liquids. Ensure sufficient ventilation and therefore cooling of the motors.

The preferred position to assemble the micro annular gear pump is horizontal. To avoid intruding fluids you may lay the pump under the actuator in vertical operation.

The mechanical assembly of the pump may not be done over the fluidic connectors or the motor.

### 4.3 Materials and liquids

The components of the micro annular gear pump heads mzr-4622 are manufactured of tungsten carbide (with 10% nickel binder) and nickel bronze.

The liquid resistance is to be checked in single cases. Feeding of non-lubricant liquid reduces the service life of the micro annular gear pumps.

### 4.4 Liquid supply

We are able to supply the micro annular gear pump head in two kinds.

#### Slip fittings

The micro annular gear pump head has two 2 mm outer diameter fluidic connectors on the front.

#### Configuration with a manifold assembly

The micro annular gear pump for fitting-in is prepared for mounting in unit constructions. The advantage of fitting-in is the small dimension for the coupling of micro annular gear pump.

You can see in figure 9 and figure 10 the assembly dimension and in figure 11 the installation position of sealing.

#### Installation space version mzr-4622 M2

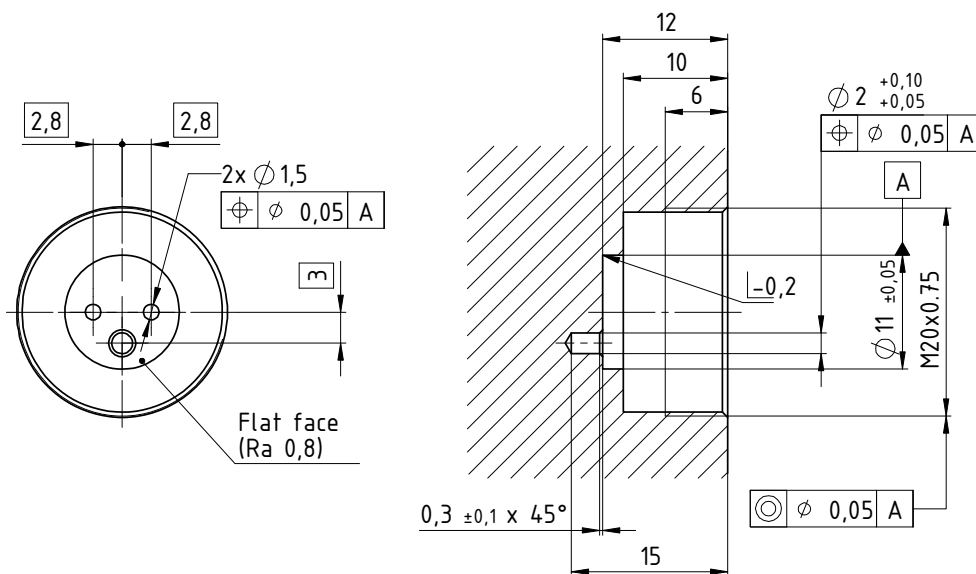

figure 9

Dimensions configuration mzr-4622 version M2

### Installation space version mzs-4622 M2.1

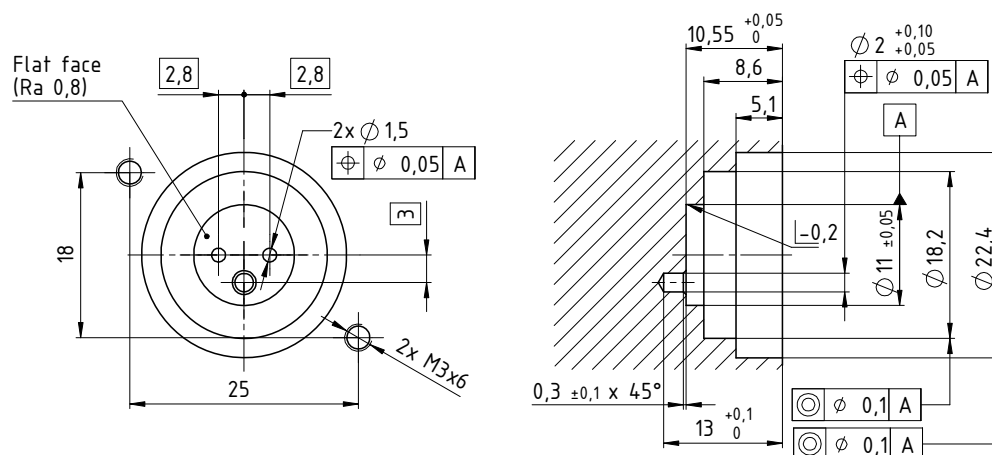

figure 10

Dimensions configuration mzs-4622 version M2.1

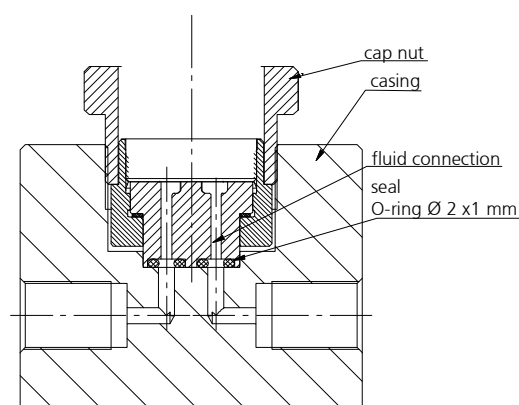

figure 11

installation position of sealing (version M2)

In order to prevent foreign bodies from penetrating into the pump, the liquid inlet and outlet are protected by plastic plugs or screws.

**Warning**

It has to be taken care the packaging of the O-rings that these sit in the scheduled groove properly. At not proper location of the O-rings the fluid terminal connection can be or get leaky.

**Warning**

Tighten the cap nut only hand screwed!  
Too firm tightening of the cap nut can rotate to one the pump housing to lead. The pump can block.

## 5 Optional modules

The spectrum of applications of the low pressure micro annular gear pump series may be expanded by using different additional modules. The modules allow for special dosage tasks, which could otherwise not be accomplished with a standard pump version. The modules may be combined with each other and with almost all available pump heads and motor versions.

- Gear box module increases the torque of the drive allowing to deliver highly viscous liquids and provides for a constant operation of the motor at low speeds (see chapter 5.1).
- By-pass module for the delivery of minimal constant flow rates down to the nanoliter range (see chapter 5.2)
- Drive with high resolution encoder enables constant operation of the motor at very low speeds (see chapter 5.3)
- Drive with high torque for viscous media, and enables even at slow speeds with a stable engine synchronism (see chapter 5.4)
- Drive without encoder (see chapter 5.6)

Due to specific requirements of each application the configuration of a given pump version should be discussed with the technical service. Additional customized modules may be designed on demand.

## 5.1 Gear box module (optional)

The gear box module enables to operate the pump at very low speeds and increases the torque of the motor for the delivery of highly viscous liquids or for application with increased operating pressure. The gear box module is available with the following reductions: 4.4 : 1, 19 : 1, 84 : 1 in combination with the pump heads mzs-4622. The length of a micro annular gear pump with the gear box module increases by 15 mm to 23 mm. For pumps with the gear box module the position of the slip fittings to the connection cable is undetermined.

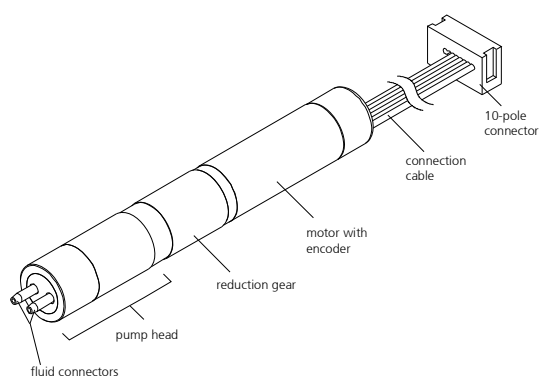

figure 12

Micro annular gear pump with the gear box module (example with mzs-2921)

Gear reduction	Length of the gear box	Total length of the pump L1	Weight of the gear box
4,4 : 1	15,5 mm	20 g	97,5 mm
19 : 1	19,1 mm	23 g	100,1 mm
84 : 1	22,7 mm	27 g	103,7 mm

table 6

Measurements of the gear box modules

Gear reduction	Max. pump speed (recommended max. motor speed 8000 rpm)
4,4 : 1	1818 U/min
19 : 1	421 U/min
84 : 1	95 U/min

table 7

Maximal pump speed with the gear box modules

## 5.2 By-pass module (optional)

The by-pass module allows constant minimal volume dosage with flow rates in the nanoliter range. The technology is based on the division of flow generated by the micro annular gear pump, according to the relationship of fluidic resistance of two predefined capillaries. The micro annular gear pump generates a master circulation from which a side dosage current is derived. This micro flow capillary allows to obtain flow rates starting at 1  $\mu\text{l/h}$ . The minimal and the maximal flow rate may differ by a factor of 1000 (dynamic factor). In order to determine the lower flow rate limit, both capillaries need to be carefully configured. It is possible to obtain flow rates between 1 and 10,000  $\mu\text{l/h}$ .

The by-pass module assures dosage of minimal amounts of liquids at a very high constancy of flow and a pressure-resistant flow rate.



figure 13

The by-pass module example with mzs-2521

Performance parameters	
Operating flow rate range	1 – 10,000 $\mu\text{l/h}$
Differential pressure range	0 – 3 bar
Max. applied inlet pressure	1 bar
Pulsation	<1 %
Operating temperature	-20 ... +60 °C
Viscosity range	0.5 – 100 mPas
Fluid connections	– Liquid intake: tube or hose, OD 1/8" – Master capillary: tube, OD 1/8" (return line to the tank) – Side current capillary: tube, OD 1/16" (dosage capillary)
Wetted parts	stainless steel 316L, PEEK
Measurements	<input type="checkbox"/> approx. 32 x 25 mm (by-pass module without pump)
Weight	approx. 140 g (by-pass module without pump)

table 8

Technical data of the by-pass module



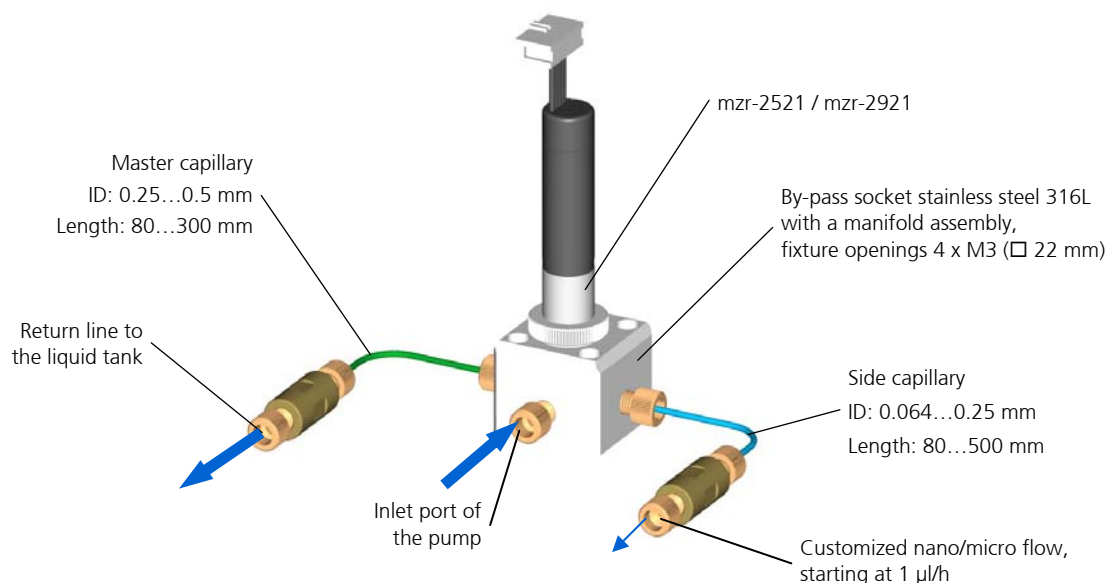

figure 14 Construction of a by-pass module with mZR-2521

### Working principle

The by-pass module shown in the figure 14 divides the flow generated by the micro annular gear pump into master and side circulation. The module serves at the same time as a support and fixture for the micro annular gear pump. The selection and configuration of the different components of the system is calculated by a PC. The master circulation capillary (the tube going back to the liquid tank) and the pump are selected and configured for each customer-specific dosage task. In this way the pump operates with the desired volumetric efficiency and can generate pressures reaching beyond the required pressure level. Depending on the difference of pressures between the delivery side of the pump and the system, a side current capillary is designed and precisely adjusted so that the desired minimal flow rate is obtained at its outlet. The flow charts of the by-pass module are verified before the shipment.

### Flow chart examples

Flow rate range 100 – 9000 µl/h

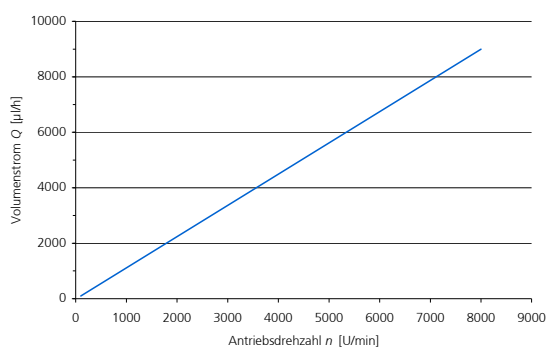

Flow rate range 0.6 – 4.4 µl/h

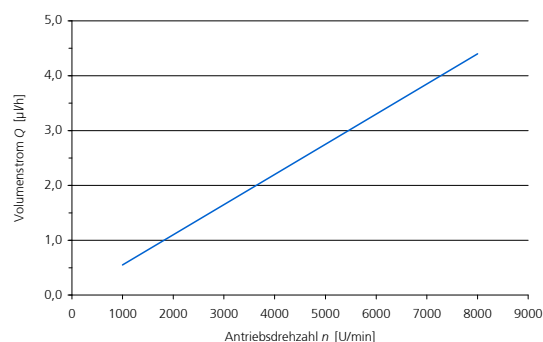

### 5.3 Drive with a high resolution encoder (optional)

The micro annular gear pump mzr-4622 can deliver alternative with an actuator equipped with a DC-motor with a high resolution encoder.

The high resolution 256 counts per turn digital MR-encoder enables to operate the pump at low speeds, starting at 1 rpm and allows at the same time a very constant motor operation.

Encoder	
Supply voltage Vcc	5 VDC
Number of channels A, B, I	2
Counts per turn	256
Output signals at Vcc = 5 VDC	TTL kompatibel
Power consumption per channel	max. 5 mA
Phase shift	90°
Operating temperature range	-25 ... + 85°C

table 9 Technical data of the high definition MR-encoder

Micro annular gear pump mzr-4622 with a high resolution encoder have the same measurements as a standard pump.



Please pay attention to the changing encoder setting during the programming and adjustment of the micro annular gear pumps.

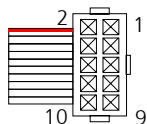

figure 15 Pin configuration of the connection socket

Pin	Description
1	Motor +
2	V <sub>cc</sub> (5 VDC)
3	SGND
4	Motor -
5	Kanal A neg.
6	Kanal A
7	Kanal B neg
8	Kanal B
9	N.C.
10	N.C.

table 10 Pin configuration of the motor

## 5.4 Drive with high torque (optional)

The micro annular gear pump mzz-4622 can deliver alternative with an actuator equipped with an DC-motor with precious metal brushes. The DC motor uses a high dynamic and is recommended for programmed dosage operation of the micro annular gear pump. With a control unit it is possible to manage lower RPM ranges down to 20 RPM. The accuracy of dosage can be achieved better than 0.5 %.

### Motor

Dimensions	
diameter of the motor	22 mm
length of the motor	32 mm
Data of capacity	
Max. voltage	18 V
Max. permanent torque	10 mNm
output power	8,6 W
No-Load speed by 18 V	7100 U/min
No-Load speed by 20 V	6000 U/min
max. permanent current	630 mA
Terminal resistor	9,04 $\Omega$
Rotor inductance	0,4 mH
RPM speed range	20– 6.000 U/min
Temperature range	-30 ÷ +85 °C

table 11

Technical data of the motor

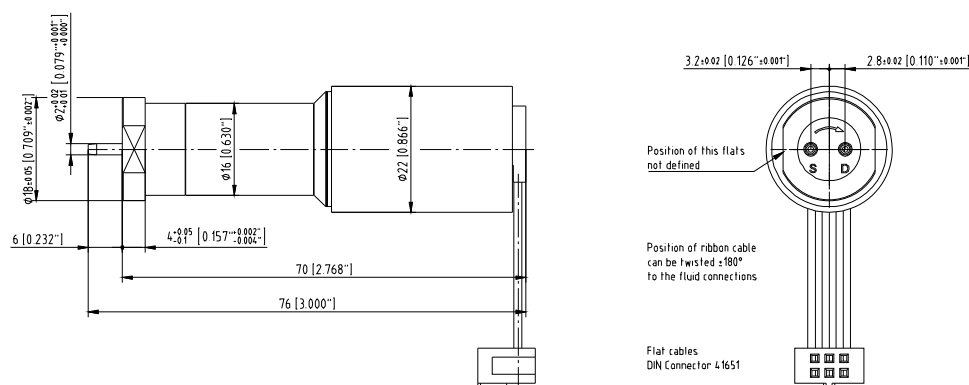

figure 16

Measurement with special motor

The motor is delivered with a Digital Magnet Encoder with 64 cycles per revolution and channel.

Encoder	
Max. voltage	4,5 – 5,5 VDC
Count of channel A, B	2
cycles per revolution and channel	64
signal by $V_{cc} = 5$ VDC	TTL compatible
Supply current	max.5 mA
phase	90°
Temperature range	-25 ÷ + 85°C

table 12 Technical data of the Encoder

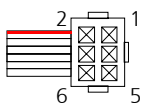

figure 17 Pin configuration of the motorcable 6 poles

Pin	Description
1	Motor -
2	Motor +
3	GND
4	$V_{cc}$ (5 VDC)
5	Channel B
6	Channel A

table 13 Pin configuration of the motorcable 6 poles

#### Warning

The micro annular gear pump mzs-4622 with special motor can operated with the controllers S-KD, S-ND and S-KG. At the controller S-KD it is to pay attention that the adapter board is provided with a 6-pole port and the solder points are soldered on coding F. At the controller S-ND and S-KG it is to pay attention that these can be operated only with a patch cable from a 6-pole one to a 10-pole plug.

## 5.5 Brushless DC motor as drive (option)

The micro annular gear pump mzs-4622 can alternatively be driven with a brushless DC-motor. It is characterized by higher dimensions and a wider speed range, which covers entirely the speed range of the micro annular gear pump and shows a longer service life than a brushed DC-motor.

Performance parameters	
Nominal voltage	24 V
Max. continuous torque	2.6 mNm
Power	11 W
No-load speed at 9 V	11,583 rpm
Max. continuous current	0.41 A
Terminal resistance, phase-phase	15.1 $\Omega$
Terminal inductance, phase-phase	525 $\mu$ H
Speed range	1 – 6000 rpm
Ambient temperature	-30 ... +125 °C
Type of Hall effect sensor	analog <input type="checkbox"/> digital

Legend:  Option for the S-KB control unit

table 14

Technical data of the brushless DC-motor

Function	Connection	Color
Hall sensor	A	green
Phase	A	brown
Hall sensor	B	blue
Phase	B	orange
Hall sensor	C	gray
Phase	C	yellow
Voltage	+5 V	red
Mass	GND	black

table 15

Pin configuration of the motor

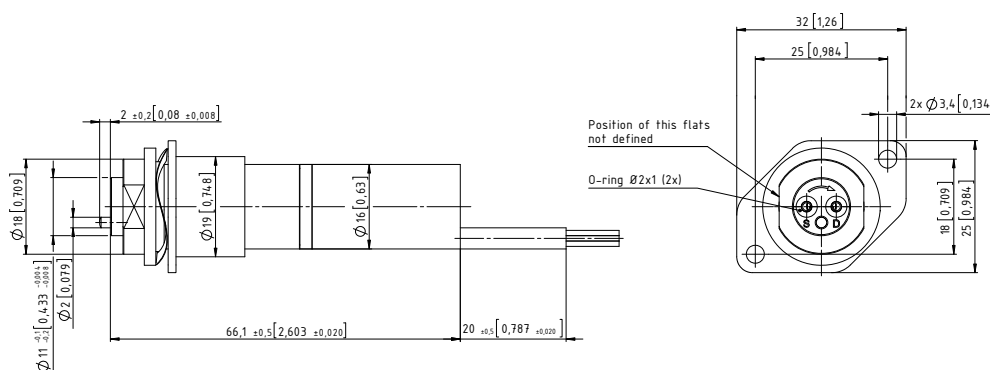

figure 18

Measurements of the micro annular gear pump mzs-4622 with a brushless DC-motor



Please notice that the brushless DC motors must imperatively be operated with an adapted control unit! The micro annular gear pumps mzs-4622 can be delivered for this purpose with optional control units S-BL.

## 5.6 Drive without encoder (optional)

The drive without encoder has been designed for use in a close circuit in which the pump works as a simple actuator.

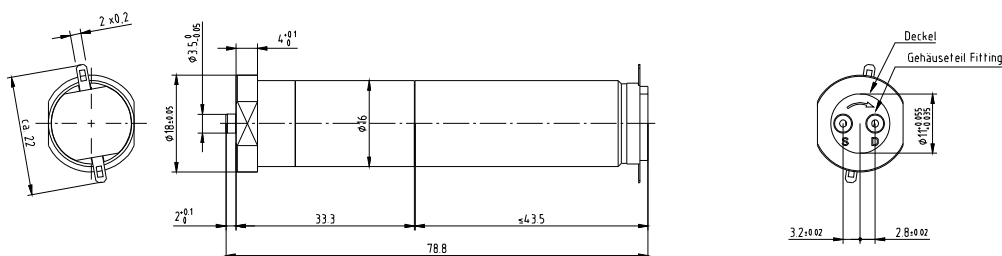

figure 19

Measurements of the micro annular gear pump mzs-4622 without encoder

## 6 System integration

### 6.1 Checkup before the first assembly

Inspect the pumps for potential damage during the shipment (see chapter 3.2).

Please check according to the following points if the right pump type has been delivered:

- Compatibility with the delivered liquid
- Viscosity range
- Pump performance (displacement volume, dosage volumes, operating pressures)
- Operating temperature range



If you notice any difference between the required and the delivered pump type, please contact HNP Mikrosysteme. Do not put the pump into operation without prior approval.

### 6.2 Mounting of the micro annular gear pump

The favored mounting position of the micro annular gear pump is horizontal. However, if the pump has to be operated vertically, the motor must be located above the pump head in order to prevent the liquid from entering into the motor.

The pump may be installed on a plastic or stainless steel cable screw M25.

#### Warning

Install the pump in such a way that in case of failure no liquid can enter to the motor or controller.



If the pump is mounted flexibly or dosing tasks require change of pump position, please fasten the cable with an adapted cable tie at the motor in order to avoid strain. If the pump is moved over a longer time, the cable may break at its connection to the motor.



Take precautions that in case of leakage no surrounding objects or environment will be exposed to danger.



The motor must be protected against humidity, dust or sweat.

### 6.3 General instructions for the assembly of the liquid supply network

Foreign bodies and dirt particles can block the micro annular gear pump and lead to its damage.

**Warning**

Please note that all the components of the liquid supply system should be clean and flush them if needed before pump installation. Remember to remove all remaining splinters or swarf from connection fittings, rests from liquid containers and any dirt from valves, tubing and filters.

**Warning**

Operate the pump with a filter featuring 10 µm or smaller pores. The filter protects the pump from particles and dirt.



If the pump is connected once again with a hose that has already been used, the enlarged ending of the hose should be cut off in order to prevent it from slipping off and the liquid from flowing out of the connection.

#### 6.3.1 Assembly of the fluid connection fittings

1. Cut the hose to a right angle by using an adapted hosecutter.

**Warning**

Remove the protection caps from the slip fittings of the pump.

2. If needed, warm up or widen the hose and slip it on the slip fitting till it touches to the housing.



Pay attention to the correct assembly of the tubing and the pump head in order to keep the default direction of flow. If you wish to operate the pump in a reverse direction, please contact one of HNP Mikrosysteme's application engineers since it is not possible in every case.

3. The intake tubing should be kept as short as possible and have a possibly large internal diameter in order to assure best intake performance.
4. In order to avoid dry operation, check before each use that enough liquid is supplied to the pump.

**Warning**

Dry run of the micro annular gear pump may damage in particular the bearing and the sealing. However, a short dry working phase at the beginning of the operation is harmless.

#### 6.3.2 Installation with the manifold assembly

1. Put the pump in the desired position for installation. Ensure that the intake and the delivery fluid connections have not been inverted.

**Warning**

Check if the o-ring 1.5 x 1 mm lay correctly and are not damaged.

2. Screw on the holding nut.



3. In order to avoid dry operation of the device, provide before each operation for a sufficient liquid supply.

**Warning**

Dry run of the micro annular gear pump may damage in particular the bearing and the sealing. However, a short dry working phase at the beginning of the operation is harmless.

### 6.3.3 Assembly instruction for tubing and accessories manifold assembly

The manifold assembly has two ports 1/4"-28 UNF for liquid supply connection.

The fluid connection fittings feature standardized plastic tubing or stainless steel tubing with a diameter of 1/16" (1.588 mm), 3 mm 1/8" (3.175 mm). The fluid connection fittings are composed of a threaded part, a lock ring and a ferrule. The seal effect is obtained thanks to the plane ending of the ferrule and the tube. The threaded part assures the required pressing force.

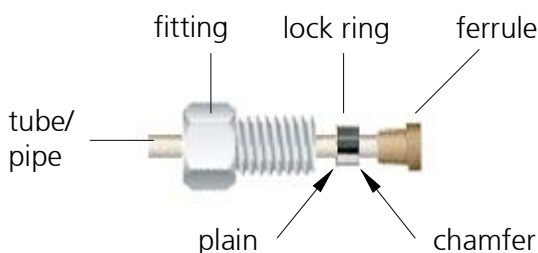

figure 20

Fluid connection fitting 1/4"-28 UNF, stainless steel

1. Cut the tube with a hose cutter to the 90° angle. Metal tubing, that produce swarf during cutting must be throughoutly cleansed and flushed. The smallest piece of swarf in the delivery system may cause failure of the micro annular gear pump.
2. Slide the fitting on the hose or tube.
3. Slide on the lock ring, chamfer towards the end of the hose or tube.
4. The ferrule should be stuck on the hose or tube in a way that the end of the tubing and the ferrule fit tightly together. The conical part of the ferrule should be directed towards the thread.
5. Put the hose or tube with the ferrule into the liquid supply ports of the micro annular gear pump. Hold the tube or hose firmly and screw in the threaded part. Retighten the stainless steel threads with a wrench by turning it about 1-1½ times. It is important that during this operation the tube remains pressed against the bottom of the liquid supply port.
6. In order to avoid dry operation of the device, provide before each operation for a sufficient liquid supply.

**Warning**

Prolonged dry operation of the micro annular gear pump may damage in particular the bearing and the sealing. However, a short dry working phase at the beginning of the operation is harmless.

## 6.4 Filter selection and use

In majority of cases it is recommended to integrate a filter on the suction side of the micro annular gear pump to ensure its secure operation. The recommended filter pore or mesh size should not exceed 10 µm. The penetration of particles or swarf that could cause a blockage or damage to the pump can only be avoided by using an adapted filter.

HNP Mikrosysteme offers a choice of standard filters covering a broad spectrum of applications. You may count on our assistance for the selection of the most suitable filter.

In order to select the best adapted filter, such operating parameters as the flow rate, the viscosity and the degree of pollution of the liquid will be needed. An increase in at least one of the mentioned terms will require the use of a bigger filtering element or pressurization of the delivered liquid. In case no suitable filter for the given high-viscosity liquid can be found, it is possible to use a filter with slightly larger pore size. Prior discussion with HNP Mikrosysteme is here recommended. A filter with larger pores is still better than no filter at all. As an alternative solution an already filtered liquid may be used.

**Warning**

Because filters have a large internal volume, it is recommended to fill in the filter and the induction (suction) tubing with already filtered liquid in order to avoid a too long dry run of the pump during the first operation.

**Warning**

Please control regularly the filtering elements for pollution. Cleanse regularly the filter or replace it with a new one. A polluted filter may considerably decrease the volumetric efficiency of a pump. Furthermore, because of the cavitation effects dosage imprecision and even pump damage may occur.

**Warning**

A too small filter (too little filtering surface) may considerably decrease the volumetric efficiency of the micro annular gear pump. What is more, because of the cavitation effects dosage imprecision and even pump damage may occur.

## 6.5 Operation with the S-ND control unit

The micro annular gear pump mzr-4622 may optionally be delivered with the S-ND control unit. This programmable control unit enables to adjust speed for constant flow rates or the position of the motor for the dosage of constant amounts of liquid. On the delivered diskettes or CDs you will find a PC-program operating under Windows that enables to program such parameters as speed, acceleration and current consumption. The delivery package comprises also a null-modem cable for connection to a serial interface of a PC.

S-ND control unit			
Type of control unit		4-Q servo amplifier	
Nominal voltage	U	24	V
Power supply	U <sub>B</sub>	12 - 30	V
Residual ripple		≤ 2 %	
Max. continuous output current	I <sub>continuous</sub>	295*)	mA
Max. peak output current	I <sub>max</sub>	600*)	mA
Speed range		10...6000*)	rpm
Input No. 1	input resistance	5	kΩ
Nominal analog speed	voltage range	± 10	V
Nominal digital speed	PWM signal	low 0...0.5 / high 4...30	V
	frequency range	100...2000	Hz
Output/Input No. 2	Error state	max. U <sub>B</sub> / 30 mA	
	no error	switched to GND	
	programmed as input	low 0...0.5 / high 3,5... U <sub>B</sub>	V
Input No. 3, 4, 5	TTL - logic level	low 0...0.5 / high 3,5...30	V
	PLC - logic level	low 0...7 / high 12,5...30	V
Program memory		6,6	kBytes

\*) Values limited in the control unit with corresponding software

table 16

Technical data of the S-ND control unit

The control unit permits an easy startup of the pump with:

- the possibility to connect the voltage supply to the delivered DIN socket
- the possibility to connect the voltage supply with screw clamps
- a 10-pole connector assembly for the motor cable
- speed set with potentiometer
- analog voltage signal 0-10 V for speed control at the screw clamps
- 9-pole connection plug for the RS-232 interface
- error output with status LED, programmable also as trigger input with screw connections
- tumbler switch S1 for the connection of digital input No. 3 of the motor control unit
- screw clamps for the connection of digital inputs No. 3, 4, 5 of the motor control unit

## Startup of the micro annular gear pump with the S-ND control unit

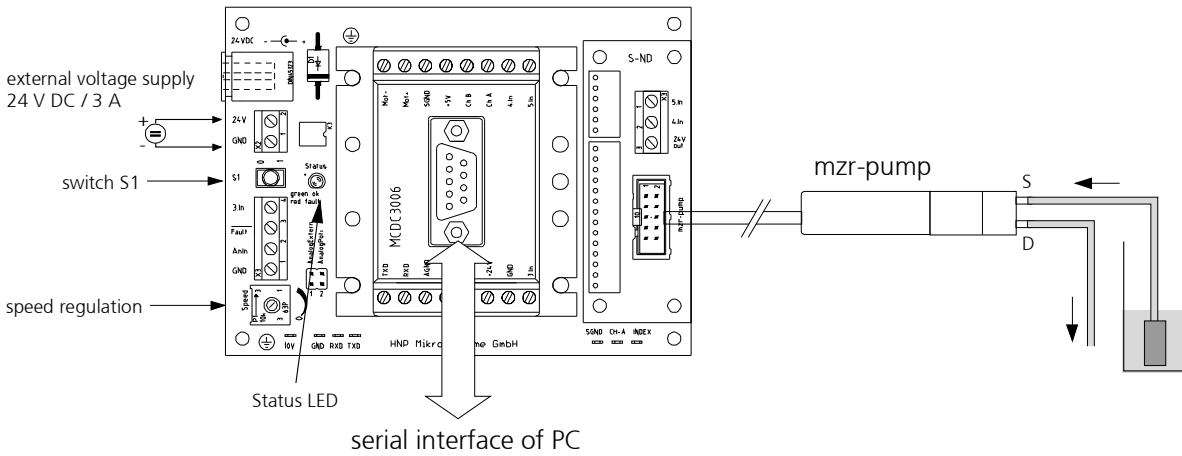

figure 21

Connection of the micro annular gear pump mZR-4622 and the S-ND control unit

1. Connect the motor cable to the 10-pole connector of the S-ND control unit. The pin configuration is indicated in table 3.
2. Connect the RS-232 port of the MCBL3006 with a free serial interface of a PC. For this purpose use the delivered 9-pole null-modem cable.
3. Put the potentiometer of the S-ND control unit to zero position by turning it clockwise to the limit stop.
4. Connect the voltage supply 24 VDC. This can be done with the integrated DIN connector or, alternatively the 2-pole screw clamp (24 V = »+«; GND = »-«). Pay attention to the correct polarity.
5. You may now install the delivered software as described in the chapter 8 or 9.



While connecting the DC voltage pay attention to the correct polarity, otherwise electronics may be damaged.

*Remarks:*

- It is possible to adjust speed of the micro annular gear pump with the potentiometer without the need to connect the serial interface.
- With the analog nominal value input (connection clamps »AnIN« and »GND«) it is possible to adjust speed of the pump with a standard signal 0-10°V. For this purpose it is necessary to plug the jumper on the S-ND control unit from the »AnalogPoti« to the »AnalogExtern«. The serial interface does not need to be connected.
- In case of an overcurrent error the green status LED on the S-ND control unit turns red
- The standard programs memorized in the motor control unit may be started with the tumbler switch S1. Basic sample programs are shown in the chapter 9. For more advanced programs please refer to the user manual for Motion Controller MCDC3006.

## 6.6 Operation with the S-KD control unit (optional)

Optionally the micro annular gear pump mzr-4622 can be delivered with the controller S-KD.

The controller S-KD controls the number of revolutions to achieve a constant flow rate. Values can be set with help of a potentiometer or with an external control signal 0-10 V. A adapter board cable is included in the delivery volume to connect the cable of the pump with the controller.

Controller S-KD			
Power supply	$U_B$	12 - 30	V
Max. output current	$I_{max}$	2*)	A
Max. power output	$P_{max}$	50	W
Velocity range	n	200...6000*)	U/min
Set Value		$\pm 10$ or $\pm 3,9$ configurable	V
Status reading »Ready«		Open collector max. $U_B / 20$ mA no fault: »Ready« = high resistance Ready: »Ready« = GND	
Disable		min. $V_{cc}-1$ V	
Dimension		approx. 114 x 100 x 34	mm
Weight		approx. 370	g
Operation temperature range		0 ... +45	°C

\*) Values are limited in the controller

table 17

Technical data motor controller S-KD

The controller is helpful for bringing into service of the micro annular gear pump easily. It comprises the following interfaces:

- adapter board cable to connect the cable of the motor with the controller
- Power supply with terminal screws
- optional potentiometer for speed control
- Analogue input 0 – 10 V with terminal screws

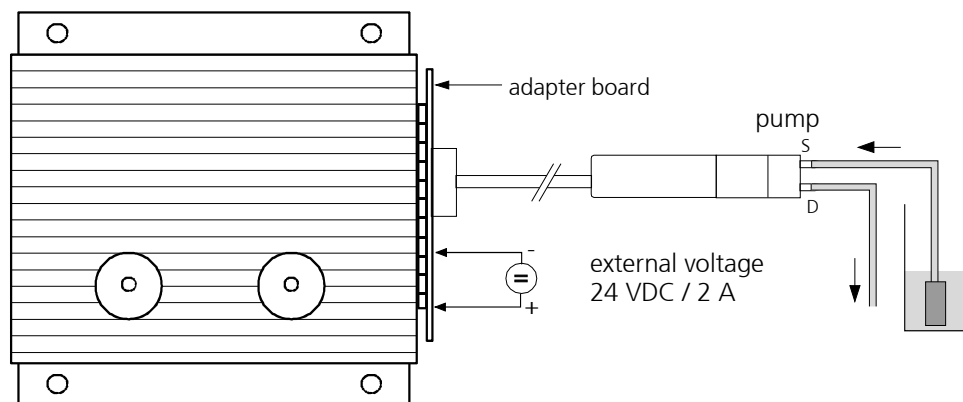

figure 22

Connection between board S-KD and micro annular gear pump mzr-4622

**Warning**

At the initial operation with the motor control of S KD you notice the enclosed technical description!

On delivery of the motor controller S-KD with adapter board and integrated potentiometer 50 k $\Omega$  only the power supply has to be attached!

**Initial operation procedure**

1. Connect the motorcable with the adapter board of the controller S-KD.
2. Connect the potentiometer of 50 k $\Omega$  with the controller (see figure 23).

Standard modus (forwards movement of the pump:

Connection of the external potentiometer between 0 V (GND) and 3,9 V only positive input signal.

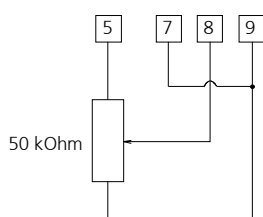

figure 23

Connection of the potentiometer (standard modus forward)

Inversion modus (backwards movement of the pump used for cleaning):

Connection of the external potentiometer between  $-3,9$  V and 0 V (GND) only negative input signal.

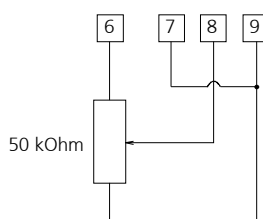

figure 24

Connection of the potentiometer (inversion modus)



The manual of the motion controller show the connection of the external potentiometer between  $-3,9$  V and  $3,9$  V for positive and negative input signals, that means the standard modus and the inversion modus works together.

3. Set the DIP switches in the following position (see table 18).

*Explanation:*

The DIP switches of the controller S-KD are adjusted for the pump mzr-4622 with the pre-adjustment (0 - 3.9 V).

no.	Pre-adjustment of DIP switches (0 - 3.9 V)	adjustment of DIP switches (0 - 10 V)
1	off	off
2	off	off
3	off	off
4	off	off
5	off	off
6	on	on
7	off	off
8	on	on
9	on	on
10	on	off

table 18

Position of DIP switches for mzr-4622

#### 4. Check the adjustment of the internal potentiometer.

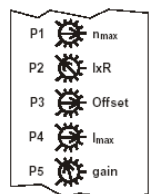



Potentiometer		Function	Turning direction	
			left 	right 
P1	$n_{\max}$	maximum speed at maximum set value	Speed lower	Speed higher
P2	$I_{xR}$	$I_{xR}$ compensation	weak compensation	strong compensation
P3	Offset <sup>1</sup>	Adjustment = 0 rpm at 0 V set value	Motor turns CCW	Motor turns CW
P4	$I_{\max}$	Current limit	lower min. approx. 0 A	higher max. approx. 2 A
P5	gain	Speed control gain	lower	higher

figure 25

Adjustment of internal potentiometer



*Explanation:*

The potentiometer of the controller S-KD are adjusted for the pump mzs-4622 with the pre-adjustment (0 - 3.9 V)

Potentiometer	function	Pre-adjustment of potentiometer or (0 - 3.9 V)	adjustment of poentiometer (0 - 10 V)
P1	$n_{\max}$	80 %	75 %
P2	IXR	0 %	0 %
P3	Offset	50 %	50 %
P4	$I_{\max}$	30 %	30 %
P5	gain	10 %	10 %

table 19

Adjustment of potentiometer

- The S-KD board is connected with the DC-power supply with 24 V to the boxes. Check for correct polarity (terminal 3 = »+«; terminal 4 = »-«).. False connecting may cause severe malfunction or even destroy the electronic of the control unit.

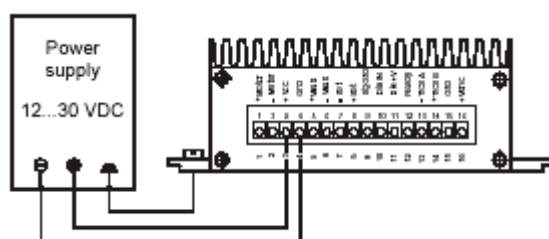

figure 26

connection of the DC-power supply

- We recommend ensuring steady liquid supply to avoid dry running of the micro annular gear pump in any case.
- Although the pump is self-priming, the hydraulic resistance on the pressure side should be minimized, when gas has to be pumped.

## 6.7 Operation with controller S-KG control unit (optional)

The controller S-KG is a small and compact 4-Q-DC servoamplifier for speed control of DC-motors with brushes and motor currents up to 0.5 A. The S-KG is especially designed for the micro annular gear pumps mzs-4622 of the low pressure series.

The controller S-KG is based on a powerful 16-bit microcontroller which achieves a high speed accuracy even at low motor speeds. For control there are several inputs and outputs, like analogue speed input, direction input, enable input, error output and a speed impulse output.

Depending on the pump type there are two controller versions available. With the controller S-KG-22 the parameters are preset for micro annular gear pumps mzs-4622. At delivery the analogue speed input is set to mode potentiometer.

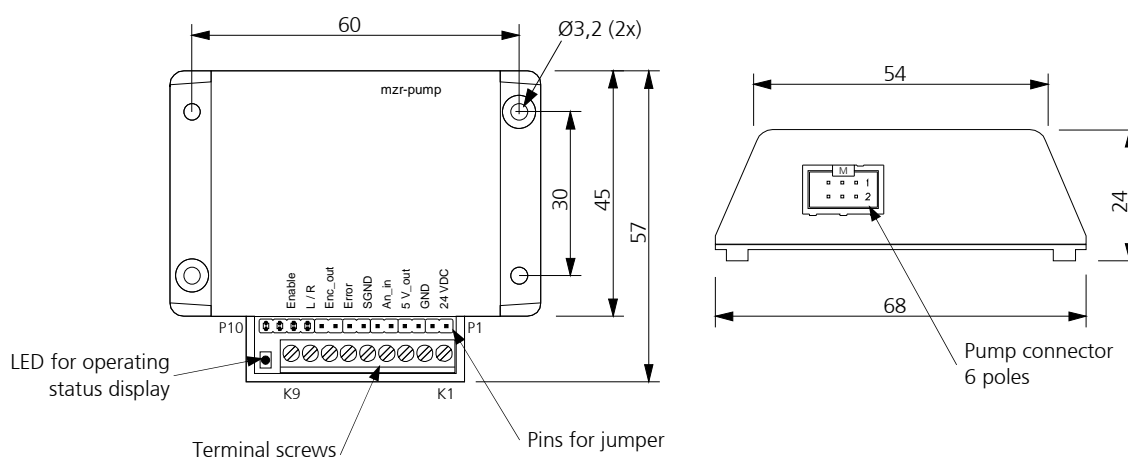

figure 27 Measurements and ports of controller S-KG

## Technical data

General technical data			
Type of control unit		4-Q servo amplifier	
Nominal voltage	U	24	VDC
Power supply	U <sub>B</sub>	10 - 24	VDC
Residual ripple		≤ 3 %	
Max. continuous output current	I <sub>continuous</sub>	0.5 *	A
Max. peak output current	I <sub>max</sub>	1	A
Total standby current	I <sub>el</sub>	0.02	A
PWM switching frequency	f <sub>PWM</sub>	20	kHz
Speed controller type		PID controller	
Speed range		100 ... 6000 *	rpm
Output voltage for external use	5V <sub>out</sub>	5	V
		max. 10 mA	
Nominal input speed	An <sub>in</sub>	10-Bit A/D-converter	
	Voltage signal	0 ... 10	V
	Potentiometer	10 kΩ (Voltage level 0 ... 5 V)	
	Current signal	4 ... 20	mA
Sense of rotation (input)	L / R	low 0 ... 0.5 / high 4 ... U <sub>B</sub> (low for clockwise operation)	V
Enable input	Enable	low 0 ... 0.5 / high 4 ... U <sub>B</sub> (low: Enable), (high: Enable optional)	V
Error output	Error	Open collector, max. 50 mA, high 4 ... U <sub>B</sub> : no error	
Speed signal output	Enc <sub>out</sub>	Open collector, max. 50 mA, Encoder signal channel A	
Weight with housing		35	g

\* Values limited in the control unit with corresponding software

table 20

General technical data

Pin	Description
K1	24 VDC
K2	GND
K3	5 V <sub>out</sub>
K4	An <sub>in</sub>
K5	SGND
K6	Error
K7	Enc <sub>out</sub>
K8	L / R
K9	Enable

Table 21

Pin configuration terminal screw

Motor pin	Description
M1	Motor +
M2	+ 5 V
M3	Channel A
M4	Channel B
M5	GND
M6	Motor -

Motor pin configuration 6 pole connector

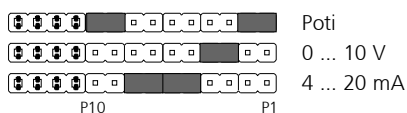
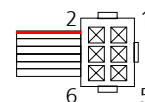

Table 22

Jumper configuration for analogue input definition

Display LED	Description
green	Power supply connected with the controller, no error
red blinking	Motor in current limit or pump blocked
green-red blinking	Speed deviation to big, pump blocked or encoder error

Table 23 LED for operating status display

## Initial operation procedure

### Power supply

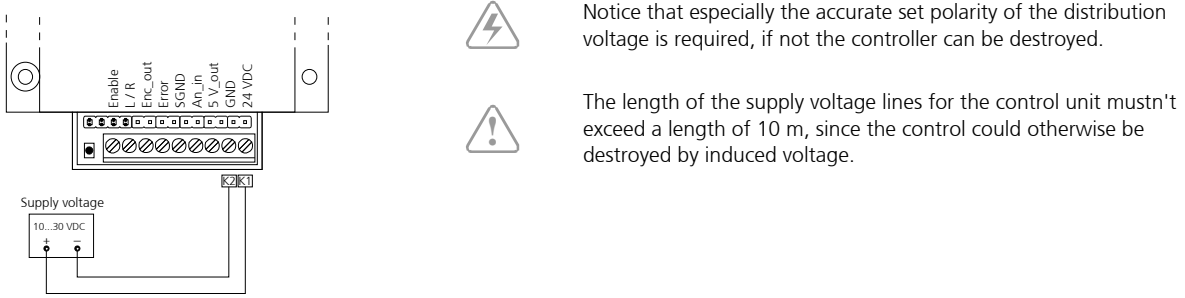

### Analogue Speed Input

#### Mode Potentiometer

Connect Pins P1-P2 and P9-P10 with two jumpers

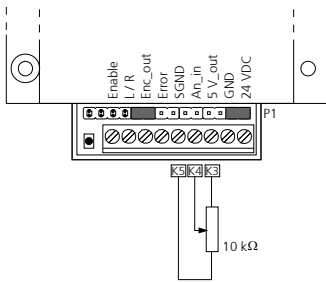

#### Mode 0 ... 10 V

Connect Pins P3-P4 with one jumper

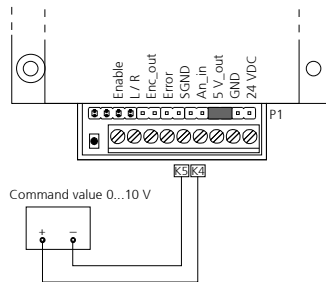

#### Mode 4 ... 20 mA

Connect Pins P5-P6 and P7-P8 with two jumpers

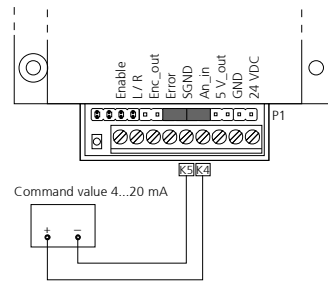

### Digital Inputs

#### Enable-input

- Not connected or low level (0 ... 0.5 V): controller activated
- High level (4 ... 24 VDC): controller deactivated

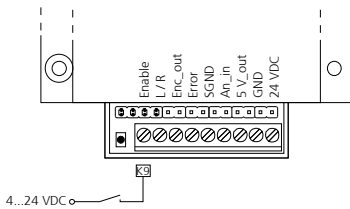

#### Direction input

- Not connected or low level (0 ... 0.5 V): motor rotates clockwise (right)
- High level (4 ... 24 VDC): motor rotates anticlockwise (left)

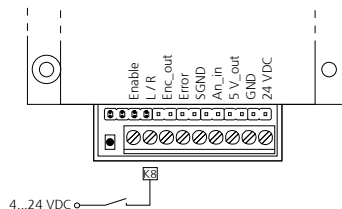

## Digital Outputs

### Error Output

Open collector output high (4 ... 24 VDC):  
no error

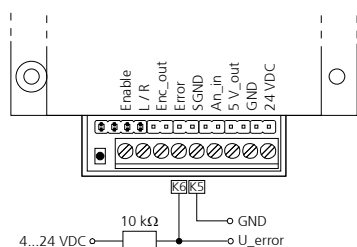

### Speed impulse output

Open collector output; corresponds with  
the channel A of the motor encoder

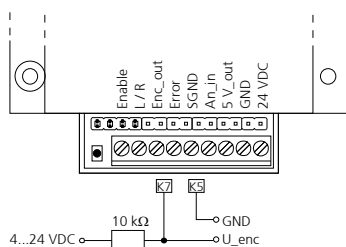

### Remark:

The micro annular gear pumps mzs-2521, mzs-2921 and mzs-4622 are equipped by default with a 10-pole motor connector. For the S-KG control unit a 6-pole motor connector has been used for a more compact design.

In order to allow connection of the micro annular gear pump to the S-KG control unit, the latter is delivered with an adapter cable.

The following description has for purpose to show you how to operate the pumps equipped with a 10-pole motor connector without the adapter cable and with the control unit S-KG.

In order to replace the 10-pole motor connector with a 6-pole one, follow these steps:

- Cut off the 10-pole connector at the ribbon cable inlet with a cutter or scissors
- Place the end of the ribbon cable in the 6-pole connector, adjust its position as described in the Table 21 and press the two parts of the connector tightly together. During the assembly please pay attention to the correct connector orientation. The color mark of the ribbon cable must be placed on pin 1.

## 7 Start Up / Shut Down

### 7.1 Preparing for operation

After the liquid supply system had been completed, please check once again the operating conditions of the micro annular gear pump as according to the following points:

- Are the inlet and outlet tubes or hoses correctly connected?
- Is the entire liquid supply system clean - that means free of particles, foreign bodies, pollution or swarf?
- Has a filter been installed on the suction side?
- Has a sufficient amount of the right liquid been supplied?
- The pump does not run the risk of a longer dry operation?
- The entire liquid supply system has been checked for leakage?
- Is it possible to stop the pump by an emergency switch if an unexpected malfunction occurs at the first start?

### 7.2 Startup of the micro annular gear pump

- Switch on the voltage supply. The micro annular gear pump can now be put into operation by turning the potentiometer knob, by sending a nominal external voltage signal or with the delivered software (see chapters 8, 9).
- Start the filling in of the pump at low or middle speed (1000 - 3000 rpm).

#### Warning

Avoid dry operation of the pump over a longer time. The pump should be filled in before it is put into operation.

### 7.3 Flushing procedure after use

After each service the micro annular gear pump should be carefully flushed with a non-corrosive, filtered and particle-free flushing liquid (see table 24 / table 25). During the flushing procedure the pump should operate at about 3000 rpm and if possible against a low pressure (that can be obtained by using a restrictor, a capillary or similar). The flushing liquid must be compatible with the delivered liquid and be suitable for solving the remaining liquid rests. Depending on the application for example water, or isopropanol may be used. If you have doubts whether a liquid is suitable for this function or not, please ask the manufacturer of the liquid or HNP Mikrosysteme.

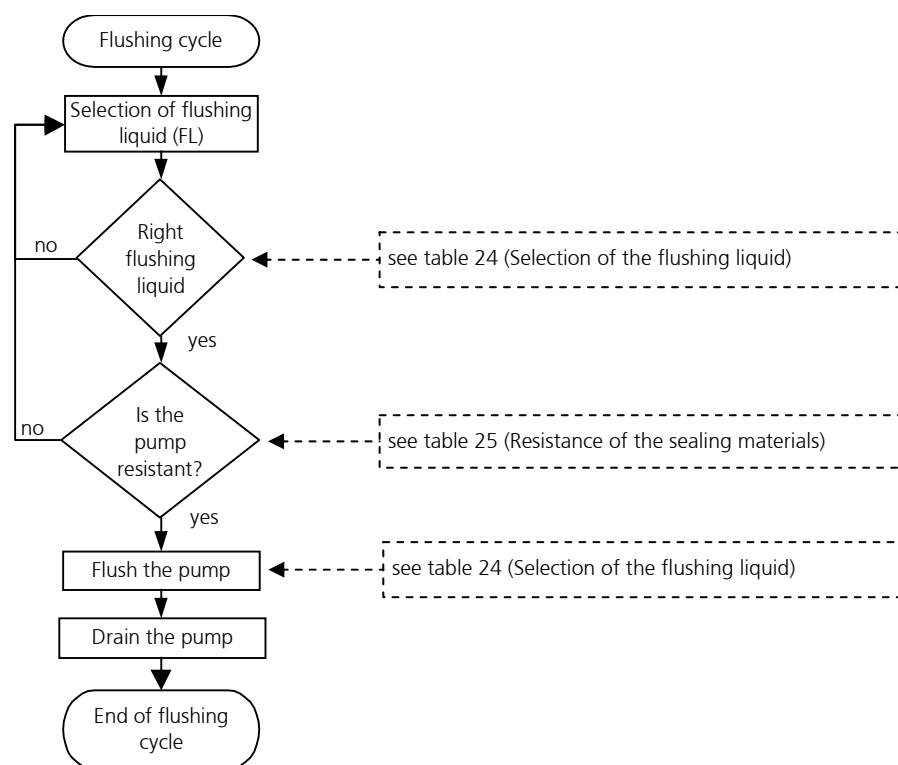

figure 28

Flushing procedure

**Warning**

Liquids remaining in the pump may crystallize, coagulate or lead to corrosion and as a consequence impair the work of the micro annular gear pump.

**Warning**

Please make sure that the pump components and particularly O-rings and sealing are resistant to the employed flushing liquid (see table 25).

**Warning**

The flushing liquid (solvent) and the recommended duration of the flushing procedure depend on the delivered liquid (see table 24). The indicated flushing liquids are simple recommendations and should therefore be checked by the user as to their compatibility and suitability.



Regulations concerning the use of substances dangerous to health should be followed!

	Nature of the handled liquid	Flushing cycle [min]	Suitable flushing liquid
1	Oils, fats, plastifiers	15-20	isopropanol, ethanol, acetone, benzine
2	Solvents (polar + nonpolar)	5-10	isopropanol, ethanol
3	Other organic liquids	10-15	isopropanol, ethanol
4	Refrigerating and cooling agents	15-20	isopropanol, ethanol
5	Neutral watery solutions	20-25	isopropanol, ethanol
6	Basic solutions	25-30	DI-water (deionized water)
7	Organic acids	30-40	isopropanol, ethanol
8	Weak mineral acids	25-30	DI- water
9	Strong mineral acids	35-45	DI- water
10	Strong oxidizing liquids	35-45	DI- water
11	Paints, varnishes, adhesives	50-60	Not specified - for further information please contact HNP Mikrosysteme.

table 24 Selection of the flushing liquid (solvent) and the duration of the flushing cycle depending on the delivered liquid.

**Warning**

Please make sure that the pump components and particularly O-rings and sealing are resistant to the employed flushing liquid (see table 25).

Flushing liquid	Shaft sealing		O-ring material		
	PTFE (Teflon®), graphite- reinforced	UHMWPE	FKM (Viton®)	EPDM	FFKM
acetone	0	0	3	0	0
benzene	0	3	1	3	0
benzyl alcohol	0	-	0	2	0
benzine	0	0	0	3	0
butanol	0	-	1	0	0
dimethyl sulfoxide (DMSO)	0	0	3	0	0
ethanol	0	0	0	0	0
isopropanol	0	0	0	0	0
methanol	0	0	2	0	0
methylethylketone (MEK)	0	0	3	1	0
oil / fine mechanics oil	0	0	0	3	0
styrene	0	-	1	3	1
toluene	0	1	2	3	0
water	0	0	0	0	0
xylene	0	1	2	3	0

Legend: 0 ... good suitability 1 ... suitability 2 ... conditional suitability 3 ... labile - ... not specified

table 25 Resistance of the sealing materials depending on the flushing liquid (solvent)



## 7.4 Shutdown of the micro annular gear pump

During the shutdown of the pump the following steps should be followed

- Flush the pump with a filtered and particle-free flushing liquid (solvent) (see chapter 7.3)
- After the flushing procedure decrease speed of the pump to 0 rpm
- Fill the pump with a suitable conservation liquid (see chapter 7.4.1)
- Remove the pump from the system (see chapter 7.4.2)

By proceeding as shown in the diagram (see figure 29) you may prepare the pump for a longer standstill.

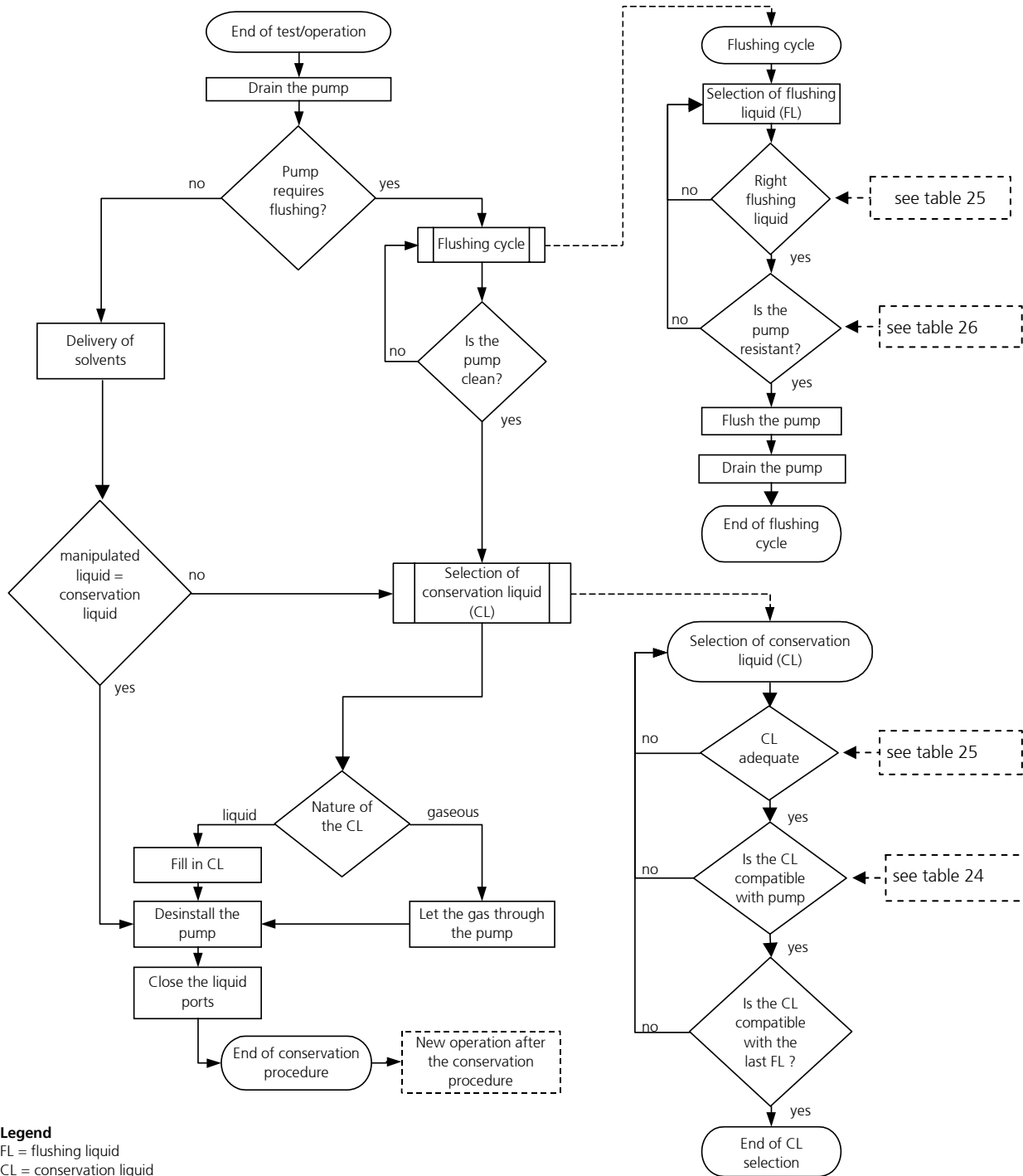

figure 29 Shutdown procedure

### 7.4.1 Conservation

If the micro annular gear pump operates at irregular intervals or for other reasons should be put out of operation for a longer period, it should, after service and flushing procedure (see chapter 7.3), be filled in with a suitable conservation liquid.

The conservation liquid may be selected from the table 26 depending on the duration of the standstill and the resistance of the pump to the manipulated liquid (table 25). The indicated conservation liquids are simple recommendations and should therefore be checked by the user as to their compatibility and suitability. The figure 30 presents the diagram of conservation liquid selection.

*Remark:* This diagram is repeated as a part of the figure 29 »Shutdown procedure«.

After the cleansing procedure the pump should be filled with a suitable conservation agent. You will find a choice of possible conservation liquids in the table 26.

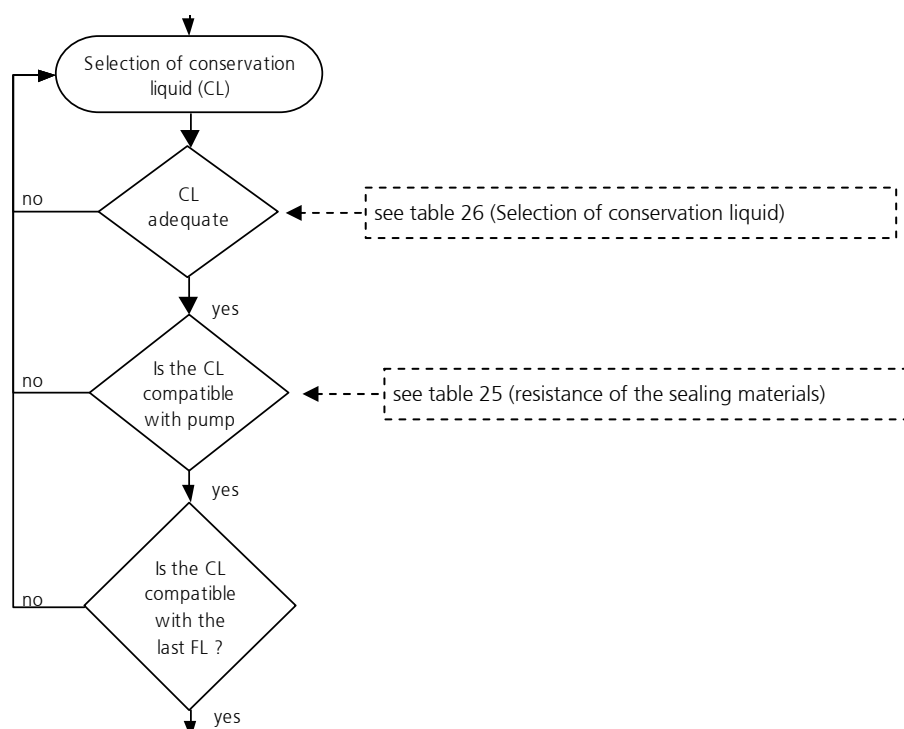

figure 30

Selection of the conservation liquid (CL)

Liquids	Solubility in water	Compatibility with the delivered liquid	Duration of storage	Breakaway torque	Toxicology	Viscosity	Description
isopropanol	+	+	o	o	o	+	solvent for organic compounds, cosmetics, essential oils, waxes and esters, antifreezers, antiseptic agents
acetone	+	+	o	o	o	+	solvent for a number of organic compounds, unlimited solubility in water, dissolves natural and synthetic resins, fats, oils and commonly used plastifiers
ethanol	+	+	o	o	o	+	solvent for organic compounds, fats, oils and resins
DI-water	+	+	-	-	+	+	solvent for many organic and mineral liquids
fine mechanics oil	-	-	+	+	+	+	cleansing and protective action (dissolves fats, tar, rubber or adhesive substances, protects against corrosion)
hydraulic oil	-	-	+	+	+	-	lubricating and preserving properties ( <i>Warning</i> : may resinatate or deteriorate with time)
nitrogen	-	+	+	+	o	+	is not a solvent, may leave deposits after drying out
air / compressed air		+	+	+	+	+	is not a solvent, may leave deposits after drying out

**Legend:** + ... good/suitable o ... satisfactory; - ... bad/inadequate

table 26

Selection of the conservation liquid

In order to prevent dust particles and foreign bodies from penetrating into the pump or the conservation liquid from leaking out, please secure the liquid input and output with the delivered protective plugs or screws.

**Warning**

Water or deionized water (DI-water) *should not* be used as conservation agents. These liquids germinate already after a few days and build a biofilm which can later block the pump.

#### 7.4.2 Dismantling of the system

- Put the drive out of operation by turning down speed to 0 rpm and by switching off the voltage supply. Make sure that the procedure described in the chapter 7.3 has been completed.
- Now that the pump has been stopped you may remove it from the system.
- Protect the inlet and outlet openings of the pump with adapted protective caps or screws.

## 7.5 Problem shooting

If the pump does not start to operate or stops the operation abruptly, please proceed as follows:

Try to liberate the micro annular gear pump:

- by turning the potentiometer knob back and forth or by sending an analog voltage signal
- via the control software
- by pressing with a syringe a suitable flushing liquid (see table 24 and table 25) through the micro annular gear pump
- by changing the operating direction of the pump.

If these measures turn out to be ineffective, please contact the service staff of HNP Mikrosysteme (see chapter 13) and send the pump back to the manufacturer for inspection.

### Warning

You should under no condition try to dismantle the pump by yourself. This may cause damage to the pump components and consequently annul your warranty claims.

## 7.6 Return of the micro annular gear pump to the manufacturer

For the return of a micro annular gear pump and components that have already been employed, please follow the instructions:

- drain any remaining rests of the delivered liquid from the pump
- flush the pump with an adapted solvent
- remove the filter elements from integrated or loosely delivered filters
- protect all openings against dust with the delivered protective plugs or screws
- return the pump in its original packing

The service personnel which carries out the repair should be informed about the condition of the used micro annular gear pump. This is done by means of the "Declaration of media in contact with the micro annular gear pump and components" (see chapter 19). This form may also be downloaded from the web site [www.hnp-mikrosysteme.de/download](http://www.hnp-mikrosysteme.de/download).



The "Declaration of media in contact with the micro annular gear pump and components" must imperatively be filled in. The nature of liquid which entered into contact with the micro annular gear pump and the components must be specified.

In case of non-compliance, the sender will be liable for any resulting injure to persons or any object damage.

## 8 Software »mzr-pump control«

Install the delivered software »mzr-pump control« from both diskettes or CDs by starting the program »Setup« on the diskette »Disk 1« or CD. The delivered software is compatible with Windows 95®, Windows 98®, Windows NT, Windows 2000® and Windows XP®.

The program enables to coordinate metering or continuous delivery tasks. The operating parameters of the micro annular gear pump are set with the included user interface.

If the diskettes »mzr-pump control« are not available because you have received for example the »Motion Manager« software instead, you may download this software from the web site [www.hnp-mikrosysteme.de/downloads.htm](http://www.hnp-mikrosysteme.de/downloads.htm). The updated version is always available in English and German.

After a successful installation the program »mzr-pump control« can be found in the start menu under »Programs - HNP Mikrosysteme«. After the program had been initiated, data such as the pump type »mzr-4622«, the encoder resolution and the gear reduction should be set.

The »Dosage« operating mode (see figure 31) enables to set constant volumes in units such as ml, mg or rpm as well as pauses for a fixed number of sequences or for continuous operation. Each metering procedure will be configured as according to speed profile which is set for such values as »Max. velocity« and the »Acceleration«. The maximal allowable speed values extend from 1 to 6000 rpm and the acceleration values from 1 to 2000 rotation/s<sup>2</sup>.

A dosage task can be initiated with the »Start« button or by pressing the enter key. The task may be stopped either with the »Stop« button or by pressing once again the enter key.

In the »Continuous flow« operating mode (see figure 32) continuous flow rates in units such as ml/min, g/min and rpm may be set. The operation of the micro annular gear pump for the indicated »Duration« value may be initiated with the »Start« button or by pressing the enter key. Checking of the »endless« box will put the pump to continuous operation. Pressing on the »Stop« button or on the enter key once again will stop the delivery. If you check the »Potentiometer« box, speed may be set by turning the potentiometer knob in the front of the control module or on the control unit.

The input of the »Fluid density« enables to convert units of weight to the given volumes or flow rates expressed in volume units.

*Remark:* if you are only working with volumes, the indication of liquid density will not be necessary and the standard value »1« can be left.

The »Calibration factor« enables to find the relation between the actually delivered quantities or flow rates (= actual value) and the set up quantities or flow rates (=nominal value). The calibration factor is specific to every pump and each application case and therefore should be determined by the user as

according to the volume or weight of the delivered liquid. The calibration factor may be calculated according to the following formula:

$$\text{Calibration factor} = \frac{\text{Desired quantity}}{\text{Actual quantity}} = \frac{\text{Desired delivery value}}{\text{Actual delivery value}}$$

In practice, due to the high precision of the system the value of the calibration factor will only slightly exceed 1.

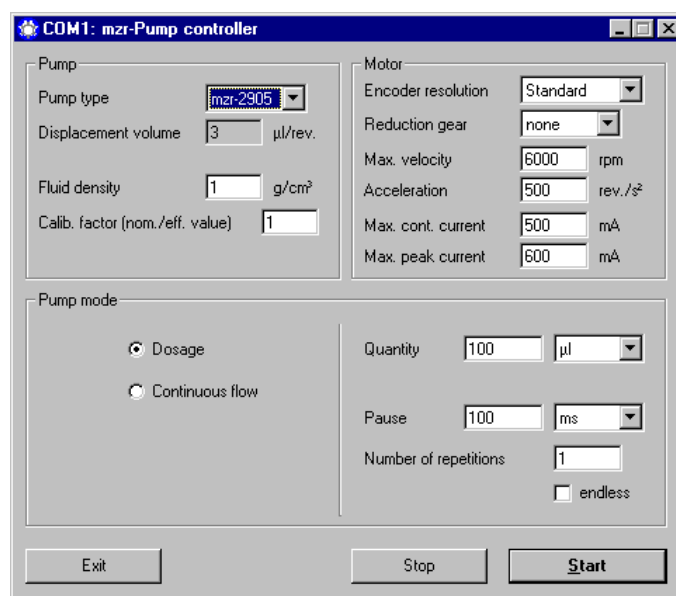

figure 31

Setup window in the »Dosage« operating mode

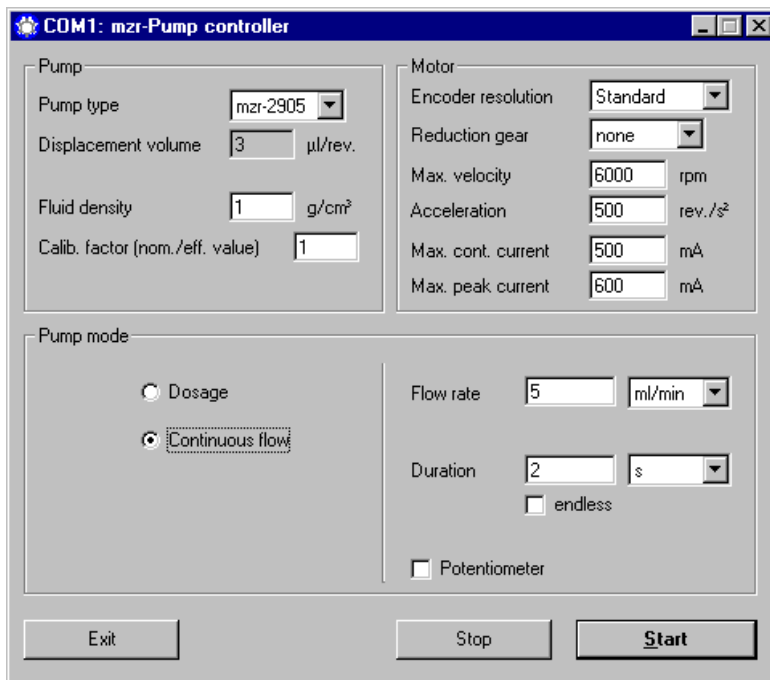

figure 32 Setup window in the »Continuous flow« operating mode



## 9 »Motion Manager« software (optional)

The »Motion Manager« software enables operation and configuration of the drive and offers a possibility of an online graphic analysis of the operating data. The software is delivered on two diskettes. The program may be installed on a PC running under Windows 95®, Windows 98®, Windows NT®, Windows 2000® or Windows XP® operating systems.

Install the software »Motion Manager« by starting the program »Setup« from the diskette »disk 1«.

If the »Motion Manager« diskettes are not available, and you have received for example the »mzs-pump control« software, you may still download this program from the web site [www.hnp-mikrosysteme.de/downloads.htm](http://www.hnp-mikrosysteme.de/downloads.htm) or the web site: [www.faulhaber.de](http://www.faulhaber.de) (menu Download - Motion Manager). Here, the latest version is always available in English and German.

After the installation the »Motion Manager« program may be loaded from the »Faulhaber Motors« folder from the Windows start menu.

In order to program the drive, the micro annular gear pump should be put into operation. The drive should be connected to the PC with the delivered null-modem cable.

### 9.1 Direct drive control

The »Motion Manager« software enables to send the input commands directly to the drive. This allows execution of movement commands and modification of the drive parameters. (see figure 33)

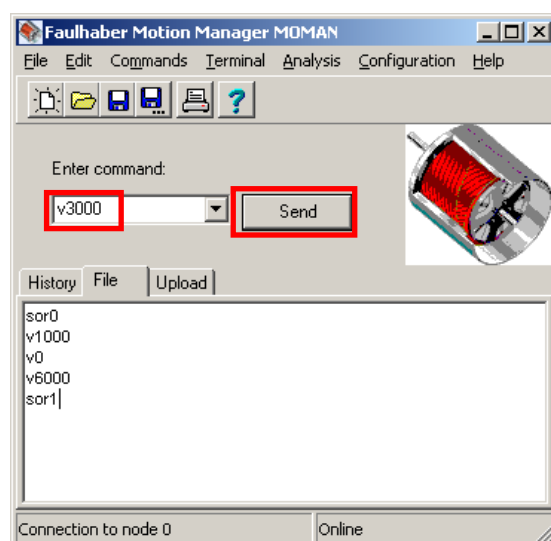

figure 33

Motion Manager software for direct control of the drive

The commands are entered in the field »Enter command:«. The button »Send« will send the command to the drive for execution (see figure 33). The commands may be given alternatively in capital or lowercase letters. Excess space characters will be ignored by the drive.

### An example for continuous delivery

Command	Description
SOR0	Set the nominal speed via the RS-232 interface
V1000	Operate the pump at 1000 rpm (for the mzs-4622 with a displacement volume of 12 µl a flow rate of 12 ml/min is obtained)
V0	Pump at rest (speed 0 rpm)
V6000	Operate the pump at 6000 rpm (Flow rate: mzs-4622 = 72 ml/min)
SOR1	Analog input operating mode: Set the nominal speed with potentiometer or by connecting a voltage signal to the analog input

### An example for discrete dosage

Command	Description
SOR0	Set the nominal speed via the RS-232 interface
LR640	Load a relative position of 640 to the control unit 640 = 5 rotation cycles, displaced volume mzs-4622 ≈ 60 µl)
M	Execute the task / start positioning
LR1280	Load a relative position of 1280 to the control unit (1280 = 10 rotation cycles, displaced volume mzs-4622 ≈ 120 µl)
M	Execute the task / start positioning
SOR1	Analog input operating mode: Set the nominal speed with potentiometer or by connecting a voltage signal to the analog input

Because of the 4-edge evaluation of the encoder signal by the control unit S-ND a quadruple number of counts per turn must always be given. In case gear box module is used, the respective gear reduction must be taken into consideration. For detailed information as to the use of Motion Manager, please read the program online help.

## 9.2 Programming of the control unit

The S-ND control unit of the micro annular gear pump may be adapted by the user to a specific application by means of an easy programming language. The program files are available in the ASCII code and have by default the »mcl« extension which stands for "motion controller language". Various parameters of the drive such as the maximal speed, the acceleration, the number of rotations to be executed, the allowable current load and the parameters of the PI-controller may be programmed. Furthermore, it is possible to program short movement sequences which will be saved in the independent memory of the drive and then autonomously executed.

A diskette with mcl-programs is included in the delivery and may be saved in the control unit.

## 9.3 Transfer of a mcl-file to the drive

The existing mcl-files may be downloaded to the editor window by selecting File – Open (see figure 34).

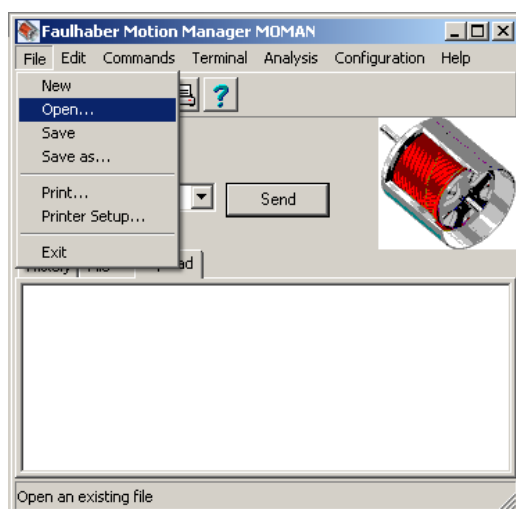

figure 34

Menu file- open

The required mcl file may be selected and loaded from the file selection window (see figure 35).

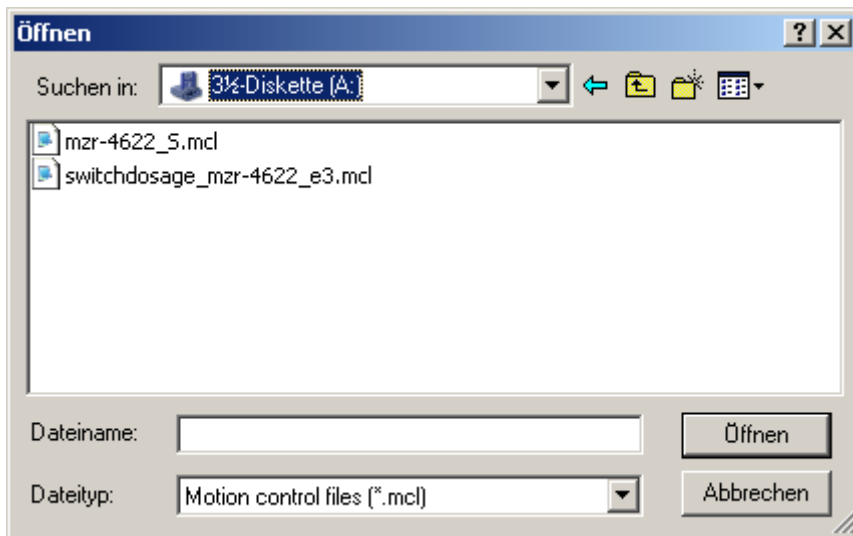

figure 35 File selection window

The mcl-file is transferred to the drive by selecting *Terminal - Transfer Configuration file* from the menu (see figure 36).

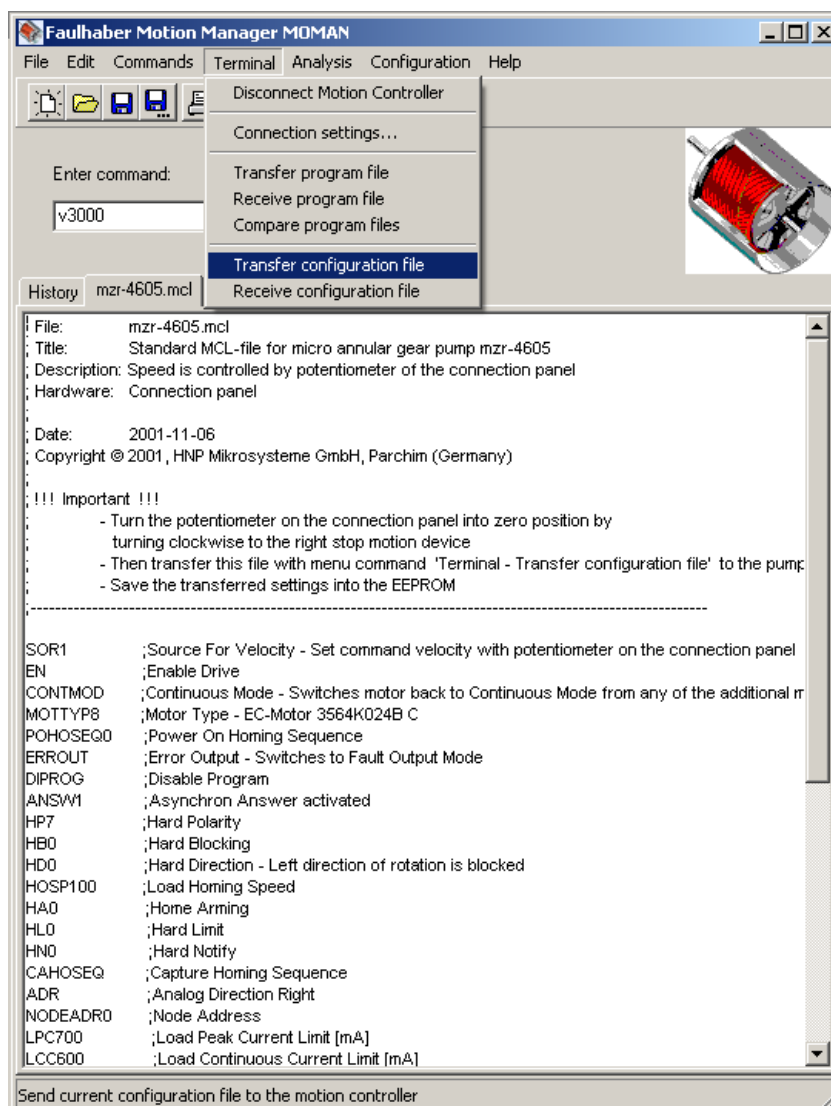

figure 36 Transfer of a mcl-file as a parameter data

When a window appears with the enquiry if the mcl files should be transferred to the »Motion-Controller«, answer by clicking on the »Yes« button.

In order to save the configuration and the programmed operation files in the EEPROM, please confirm the dialogue window with »OK« (see figure 37). With this confirmation the program will be saved in the memory with a resident status and will be available for future operation.

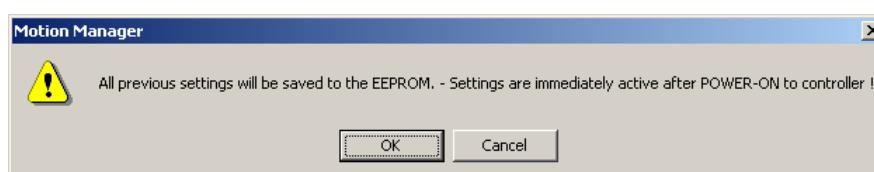

figure 37 Storage confirmation

A standard program mZR-4622\_S.mcl and a sample program switchdosage\_mZR-4622\_e3.mcl may optionally be delivered.

The standard program mZR-4622.mcl (see Listing 1) is installed by default at the delivery of the micro annular gear pump mZR-4622.

In this case the drive has the following parameter configuration:

- speed set with potentiometer (command SOR1)
- drive activation when the power supply is switched on (command EN)
- continuous operation mode of the micro annular gear pump (command CONTMOD)
- maximal speed 6000 rpm (command SP6000)
- max. peak current of the drive 600 mA (command LPC600)
- max. continuous current of the drive 295 mA (command LCC295)
- motor acceleration 500 rotations/s<sup>2</sup> (command AC1000)
- fault-pin configured as error output (command ERROUT)
- activation of automatic answering (command ANSW1)

```

; File: mZR-4622_S.mcl
; Title:Standard MCL-file for micro annular gear pump mZR-4622
; Description:Speed is controlled by potentiometer of the controller
; Hardware: Motor Maxon RE 16 /24V, Steuerung MCDC3006S on Controller S-ND
; Serial port RS-232
; Stand:2006-07-21
; Copyright © 2006, HNP Mikrosysteme GmbH, Parchim (Germany)
;
; HNP Mikrosysteme GmbH, Juri-Gagarin-Ring 4, 19370 Parchim
; Telefon +49(0)3871/451-301, Telefax +49(0)3871/451-333
; Email info@hnp-mikrosysteme.de, http://www.hnp-mikrosysteme.de
;
; !!! Important !!!
; - Turn the potentiometer on the connection panel into zero position by
;   turning clockwise to the right stop motion device
; - Then transfer this file with menu command 'Terminal - Transfer configuration file' to the pump
; - Save the transferred settings into the EEPROM
;
;-----
; Configuration
;-----

SOR1           ;Source For Velocity
CONTMOD        ;Continuous Mode
KN589          ;Speed Konstant
RM11200       ;Motor resistance
APL0           ;Position Limits
MOTYP0        ;Motortype
POHOSEQ0      ;Power On Homing Sequence
ERROUT        ;Error Output
HP7           ;Hard Polarity
HB0           ;Hard Blocking
HD0           ;Hard Direction
HOSP100       ;Load Homing Speed
SHAO          ;Set Home Arming
SHL0          ;Set Hard Limit
SHN0          ;Set Hard Notify
ADR           ;Analog Direction Right g
LPC600        ;Load Peak Current Limit
LCC295        ;Load Continius Current Limit
AC1000        ;Load Command Acceleration
DEC1000       ;Load Command Deceleration
POR1          ;Load Velocity Proportional Term

```

```

I25                ;Load Velocity Integral Term
PP162              ;Load Position Proportional Term
PD5                ;Load Position D-Term
CI16               ;Load Current Intergral term
SP6000             ;Load maximum Speed
MVO                ;Minimum Velocity [rpm]
MAV25              ;Minimum Analog Voltage [mV]
LL600000000       ;Load Position Range Limits
LL-600000000      ;Load Position Range Limits
LPN10              ;Load Puls Number
STW1               ;Load Step Width
STN32              ;Load Step Number
ENCRES128          ;Load Encoder Resolution
DEV50              ;Load Deviation
DCE200             ;Delayed Current Error
CORRIDOR10        ;Load Corridor
SINO               ;Sinus Commutation deactivated
SETPLC             ;Set PLC-Inputs
EN                 ;Enable Drive
DIPROG             ;Disable Program
COMPATIBLE0       ;Deactivated Compatible Mode
SR18               ;Load Sample rate
NET0               ;Set Network Mode
NEO                ;Notify Error
ANSW1              ;Answer Mode
NODEADRO           ;Define Node Address
VO                 ;Select Velocity Mode

;-----
; Programm
;-----

PROGSEQ            ;write and save an empty program sequence (clear program memory)
END

```

Listing 1

file mzs-4622.mcl

The switchdosage\_mzr-4622\_e3.mcl file (see Listing 2) is a sample program for discrete dosage with the micro annular gear pump.

The dosage task is started with the switch S1 located between the connection clamps »24V« and »3.In« on the connection board. Buttons, shutters or no-load contacts of a programmable controller with interchangeable memory (PLC) may be used as interruptors.

The drive is configured as according to the following parameters:

- Execution of 10 rotation cycles (command LR640) (640 = 10 rotation cycles, displacement volume mzr-2521  $\approx$  15  $\mu$ l; mzr-2921  $\approx$  30  $\mu$ l)
- Start the dosage task with the integrated switch (command REFIN)

```

; File:          switchdosage_mzr-4622_e3.mcl
; Title:         Dosage triggered with switch for mzr-4622
; Description:   A fluid quantity which is defined by relative target
;               position of the motor will be triggered with switch
; Hardware:     Motor Maxon RE 16 /24V, Steuerung MDC3006S on Controller S-ND
;
; Stand:        2006-07-21
; Copyright © 2006, HNP Mikrosysteme GmbH, Parchim (Germany)
;
; HNP Mikrosysteme GmbH, Juri-Gagarin-Ring 4, 19370 Parchim
; Telefon +49(0)3871/451-301, Telefax +49(0)3871/451-333
; Email info@hnp-mikrosysteme.de, http://www.hnp-
mikrosysteme.de
;
;!!! Important !!!
;   - Turn the potentiometer on the connection panel into zero position by
;   turning clockwise to the right stop motion
device
;   - Then transfer this file with menu command 'Terminal - Transfer
configuration file' to the pump
;   - Save the transferred settings into the EEPROM
;
;-----
; Program sequence
;-----

PROGSEQ
A1      ;Label 1 (program start)
HP4     ;Rising edge active and logic level to High for input
No. 3
A2      ;Label 2
JPT2    ;Jump to label 2 if logic level of input No. 3 is low

HP0     ;Falling edge active and logic level to Low for input No. 3
A3      ;Label 3
JPT3    ;Jump to label 3 if logic level of input No. 3 is high

LR1280  ;Load relative target position (128 = 1 rev.)      <+++++ Please
edit the target position value !
NP      ;Notify Position (wait after "M" until target
position is reached)
M       ;Move to target position
HO      ;Home arming

JMP1    ;Jump to the beginning
END

;-----
; Configuration
;-----

```



```

SOR0          ;Source For Velocity
EN            ;Enable Drive
CONTMOD       ;Continuous Mode
KN589         ;Speed Konstant
RM11200       ;Motor resistance
POHOSEQ0     ;Power On Homing Sequence
ERROUT       ;Error Output
DIPROG       ;Disable Program
ANSW1        ;Asynchron Answer activated
HP7          ;Hard Polarity
HB0          ;Hard Blocking
HD0          ;Hard Direction
HOSP100      ;Load Homing Speed
HA0          ;Home Arming
HL0          ;Hard Limit
HN0          ;Hard Notify
CAHOSEQ      ;Capture Homing Sequence
ADR          ;Analog Direction Right
NODEADR0     ;Define Node Address
LPC600       ;Load Peak Current Limit [mA]
LCC300       ;Load Continius Current Limit [mA]
AC1000       ;Load Command Acceleration [U/s²]
I40          ;Load Integral Term
POR3         ;Load Proportional Term
SP6000       ;Load Command Velocity [U/min]
MV0          ;Minimum Velocity
MAV23        ;Minimum Analog Voltage [mV]
LL600000000  ;Load Position Range Limits
LL-600000000 ;Load Position Range Limits
LPN10        ;Load Puls Number
STW1         ;Load Step Width
STN32        ;Load Step Number
ENCRES128    ;Load Encoder Resolution
V0           ;Select Velocity Mode [U/min]
ENPROG       ;Enable Program - start the program sequence
immediately after power-on

```

Listing 2

file switchdosage\_mzs-4622\_e3.mcl

## 10 Accessories for microfluidic systems

The accessory range for the liquid delivery systems of HNP Mikrosysteme comprises complementary equipment such as supplementary modules, hoses, tubing, fluid connection fittings, filters and non-return valves that are best adapted to your micro annular gear pump. We will eagerly share our long date experience as far as component selection is concerned.

## 11 Non-liability clause

HNP Mikrosysteme GmbH shall not be liable for damages resulting from the non-respect of instructions comprised in this operating manual.

It remains at the responsibility of the user to conform to all laws, rules and regulations in force. This applies above all to the handling of aggressive, poisonous, corrosive and other dangerous liquids as well as to the electromagnetic compatibility (EMC).

## 12 Problem shooting

Disturbance	Cause	Solution
1 The pump does not start operation.	No power supply	Check the power supply.
2 The pump does not deliver any liquid.	No liquid in the primary tank.	Fill the recipient/tank with liquid.
	Presence of air or gas in the pump	The pump cannot run dry against the system pressure. Fill in the pump at no pressure or at reduced system pressure.
	Malfunction of the liquid supply system (such as in the delivery tube or hose, the needle or external non-return valve)	Check the components for possible disturbances to be eliminated. Cleanse the accessories if needed.
	Failure of the electric installation.	Check the electric installation for the correct cable configuration, loose contacts, etc.
	The pump did not receive the start signal or start conditions are not fulfilled.	Check if the start conditions have been fulfilled start signals (PLC, start input) and the programming.
3 The pump does not start to operate.	Motor fault: Status LED of the control unit S-ND turns red.	Check the error status of the S-ND control unit with the Motion Manager software. Read the operating manual for the motor control unit.
	The pump does not take in the liquid.	The tubing on the suction side is too long or has a too small internal diameter (a too low NPSHA value). The tubing or the fluid connection on the suction side are not tight. Please check the intake connection and the tubing. Air bubbles in the system (tubes, valves, ...) If the viscosity of the liquid is too high, apply pressure on the suction side. Check the pressure exerted on the primary liquid tank. An external non-return valve does not open. Check the non-return valves. Submit the non-return valve to a higher pressure, so that the pump may fill in.
4 The motor turns, but the pump does not operate.	No liquid in the pump	Fill the pump with liquid.
	Air bubbles in the liquid supply system (tubing, valves, ...)	Fill the pump and the liquid supply system with liquid.
	The non-return valve does not open.	Rinse the non-return valve.
	Blocked delivery tubing or needle	Cleanse, flush or exchange the delivery tubing or dosage needle.
	The coupling between the motor and the pump is out of position.	Return the pump to the manufacturer.
5 The pump is filled with liquid, but does not pump it.	The pump shaft is broken.	Return the pump to the manufacturer.
	Error indicator (the status LED has turned red and the motor control has set the error output.)	Check the motor error status with the Motion Manager software (command GFS). Try to liberate the pump by making it operate in a reverse direction for 1 s with - 1000 rpm. Adapt the motor current of the control. Contact the manufacturer of the pump.
	Presence of particles in the delivered liquid or blockage of the pump	Check the motor error status with the Motion Manager software. Try to liberate the pump by making it operate in a reverse direction for 1 s with - 1000 rpm.

Disturbance	Cause	Solution
		Flush the pump with a syringe.
		Return the pump to the manufacturer for cleansing. Use a filter, flush the liquid delivery system.
	The non-return valve does not open.	Rinse the non-return valve.
	Blockage of the delivery tubing or the needle	Cleanse, flush or exchange the delivery tubing or the needle.
	Air bubbles in the liquid delivery system (tubing, valves)	Fill in the pump and the liquid delivery system with liquid.
6 Dosage volume does not correspond to the desired values.	Air bubbles in the liquid delivery system (tubing, valves ,...) and the pump	Vent the liquid delivery system and check for untight fluid connections.
	Pump shows cavitation.	Too long or too narrow intake tubing. Shorten the intake tubing or change the position of the pump.
	Polluted or too small filter	Change the filter to a new or bigger one.
	The non-return valve does not open.	Rinse the non-return valve.
7 Speed of the pump cannot be adjusted.	Defective electric installation	Check the electric installation for correct cable configuration and loose contacts.
	Defective drive control	Return the drive control unit to the manufacturer.
	Encoder cable disconnected	The motor works at high speed. Check the installation, return the pump to the manufacturer for checkup.
8 Liquid drops from the dosing needle.	The non-return valve does not close.	Rinse the non-return valve.
	Too high pressure on the primary liquid tank	Stop the delivery of compressed air on the primary liquid tank.
	The liquid tank is at a higher level than the dosing needle.	Place the liquid tank at the same or slightly lower level as the pump.
9 Liquid leaks out of the sealing module.	Too high pressure on the sealing liquid supply cartridge or defective sealing	Stop pressurizing the sealing liquid supply cartridge. If needed return the pump to the manufacturer.
10 Dosage volume decreases with time.	Polluted filter	Exchange the filter.
	Deposits in the pump	Flush the pump or return it to the manufacturer for dismantling and cleaning.
	The pump is worn after a long operating period or after use with abrasive liquids.	New definition of the calibration factor of the pump, by modifying the pump characteristics graph necessary.
11 Leakage from the pump	The sealing does not function correctly.	Return the pump to the manufacturer.
12 Leakage from the coupling assembly	Defective shaft seal	Return the pump to the manufacturer in order to change the shaft sealing.
13 Leakage from the fluid connections	Untight locking rings	Exchange or tighten the fluid connections, exchange the fluid connection.
14 Air bubbles on the delivery side.	Loose fluid connections (particularly on the induction (suction) side)	Check and tighten the fluid connections.
	The shaft seal is untight or worn.	Return the pump to the manufacturer.
15 The error status of the pump cannot be retrieved.	No connection with the pump	Check the supplied voltage.
		Check the connection of the interface with the null-modem cable. Replace the cable if needed.
	The motor control unit does not respond.	Turn off the voltage supply for a short time, then turn it on again. Start the pump automatically with the integrated control unit.
16 Minimal leakage during standstill	No error, cause relative to the operating principle	Use a non-return valve. Place the liquid tank at the same or slightly

Disturbance	Cause	Solution
17 Excess temperature		lower level as the pump.
	The surface of the pump is hot.	Clean the surface of the pump, rinse the pump.
	The pump operates with difficulty.	The pump should be flushed.
	Particles in the delivered liquid or deposits in the pump	The operation of the pump should immediately be stopped! Return the pump to the manufacturer for cleansing.
	Noise of beveling	The operation of the pump should immediately be stopped! Return the pump to the manufacturer for cleansing and repair.
18 The pump is noisy.	The motor surface or the motor interior are too hot.	High temperature indicator in the drive is on. The motor has been shut down by the thermistor. Return the pump to the manufacturer.
	Wear out of the pump or defective components.	Do not continue to operate the pump, return it to the manufacturer for maintenance.
19 Overcurrent	Particles in the delivered liquid	Rinse the pump.
	The pump operates with difficulty.	Dosing needle is damaged. Needle should be cleansed, flushed or exchanged. Tubing on the delivery side, dosing needle or the non-return valve are blocked. Cleanse, flush or exchange the components.
	Deposits inside the pump.	Flush the pump. If necessary return the pump to the manufacturer.
20 Undervoltage	Voltage supply < 12 VDC	Check the power supply 24 VDC
21 Overvoltage	Voltage supply > 28 VDC	Check the power supply 24 VDC. The drive control unit may be damaged. Return the pump to the manufacturer.

table 27

Problem shooting



If a disturbance that has not been mentioned in the above list, or that makes the use of the micro annular gear pump unsafe appears, please stop the operation of the pump without delay and contact HNP Mikrosysteme (see chapter 13). If needed return the pump to the manufacturer for checkup.

## 13 EC Directive

A Directive or EC Directive is a legal instrument of the European Community addressing at the member states and forcing them to implement specific regulations or targets. Leastwise, micro annular gear pumps are covered, by the scope of application of the following Directives: The following directives are of importance for the user of the described micro annular gear pumps:

### **Low-Voltage Directive (2006/95/EC)**

The Low-Voltage Directive is not relevant for micro annular gear pumps described in this manual, because the supply voltage is limited to a maximum of 30 VDC.

### **Machinery Directive (2006/42/EC)**

A micro annular gear pump is a machine and is consequently covered by this Directive. However, it may be a part of a machine or installation.

### **EMC Directive (2004/108/EC)**

The Directive on Electromagnetic Compatibility (EMC) applies to all electronic and electrical devices, installations and systems. Consequently, the Motion Controller of the micro annular gear pump is covered by the EMC Directive.

### **RoHS Directive (2011/65/EC)**

To our knowledge our products delivered to you do not contain substances or applications in concentrations that are forbidden by this directive. No substances contain our products delivered to you after our current knowledge in concentrations or application, the placing on the market in products according to the valid requirements forbade to the Directive.

### **WEEE Directive (2002/96/EC)**



Disposal of micro annular gear pumps has to be environmentally sound. All materials and liquids have to be recycled in accordance with the relevant regulations. Electrical parts can not be disposed of as household waste. They have to be delivered to designated collection points.

## REACH regulation (EC) No. 1907/2006

HNP Mikrosysteme is not a manufacturer or importer of chemical substances subjected to registration, but in terms of regulation, a downstream user. As downstream user, we conduct the necessary communication with our suppliers to ensure future deliveries of all components necessary to us. We will notify you of all relevant, changes in our products, their availability and the quality of parts/products delivered by us within our business and coordinate the appropriate action in individual cases with you. Previous inspection did not show any limitation in the supply of material from our upstream suppliers.

### 13.1 Electromagnetic Compatibility (EMC)

Electromagnetic compatibility is defined as the ability of a electric or electronic device to function satisfactorily as intended in its electromagnetic environment without introducing intolerable electromagnetic disturbances in that environment.

#### 13.1.1 EMC Directive and Standards

Comformity was proven by proof of compliance with the following harmonized standards by the company Dr. Fritz Faulhaber:

- EN 61000-6-4 (10/01): Generic standards – Emission standard for industrial environments
- EN 61000-6-2 (10/01): Generic standards – Immunity for industrial environments

These standards prescribe certain standardised tests for the emitted-interference and interference-immunity tests. The following tests are required due to the connections on the controller:

Generic Standard on Emitted Interference:	Description
EN 55011 (05/98)+A1(08/99)+A2(09/02):	Radio disturbance characteristics
Generic Standard on Interference Immunity	
EN 61000-4-2 (05/95)+A1(4/98)+A2(02/01):	Electrostatic discharge immunity test
EN 61000-4-3 (04/02)+A1(10/02):	Radiated, radio-frequency, electromagnetic field immunity test
EN 61000-4-4 (09/04):	Electrical fast transient/burst immunity test
EN 61000-4-5 (03/95)+A1(02/01)	Surge immunity test
EN 61000-4-6 (07/96)+A1(02/01):	Immunity to conducted disturbances, induced by radio-frequency fields
EN 61000-4-8 (09/93)+A1(02/01):	Power frequency magnetic field immunity test

Table 1

Standards Summary

All tests were conducted successfully.

### 13.1.2 Information on use as intended

For micro annular gear pumps, note the following:  
Requirement for the intended operation is the operation according to the technical data and the manual.

#### **Restrictions**

If the micro annular gear pumps are used at home, in business or in commerce or in small businesses, appropriate measures must be taken to ensure that emitted interferences are below the permitted limit values!

#### **Installation instructions:**

For the control unit S-KG no further conditions must be fulfilled in order to comply with the EMC-protection requirements.



## 14 Declaration of conformity

The delivered micro annular gear pump falls within scope of the following EC directives:

- Machinery Directive (2006/42/EC)
- EMC Directive (2004/108/EC)

You may request the declarations of conformity for the micro annular gear pumps from us separately.



## **EC-manufacturer's certificate (following Machinery Directive 2006/42/EC)**

We hereby declare that the following micro annular gear pumps of the high performance series:

### **mzr-4622**

are intended for installation into another machinery/plant and that start of operation is forbidden until it is identified that the machinery/plant into which these micro annular gear pumps shall be installed corresponds to the regulations of the EC guidelines regarding safety and health requirements.

We confirm the conformity of the product described above to the following standards in terms of applied directives

- Machinery Directive (2006/42/EC)

Applied standards are particularly

DIN EN 809	DIN EN 60204-1	DIN EN 294
DIN EN ISO 12100 part 1		DIN EN 953
DIN EN ISO 12100 part 2		UVV

This statement does not warrant any characteristics in terms of product liability. Please note the safety instructions in the manual.

Mr. Lutz Nowotka, HNP Mikrosysteme GmbH, Bleicherufer 25, D-19053 Schwerin is authorised to compile the technical file according to Annex VII A.

Date: 30 December 2009

Signature manufacturer:

Dr. Thomas Weisener  
CEO



## **EC-manufacturer's certificate (following EMC Directive 2004/108/EC)**

We hereby declare that the following micro annular gear pumps of the high performance series:

### **mzr-4622**

are intended for installation into another machinery/plant and that start of operation is forbidden till it is identified that the machinery/plant into which these micro annular gear pumps shall be installed corresponds to the regulations of the EC guidelines regarding safety and health requirements.

We confirm the conformity of the product described above to the following standards in terms of applied directives

- EMC Directive (2004/108/EC)

Applied standards are particularly

- |                       |   |
|-----------------------|---|
| EN 61000-6-4 (10/01): | Generic standards – Emission standard for industrial environments |
| EN 61000-6-2 (10/01): | Generic standards – Immunity for industrial environments          |

This statement does not warrant any characteristics in terms of product liability. Please note the safety instructions in the manual.

Date: 30 December 2009

Signature manufacturer:

Dr. Thomas Weisener  
CEO



## 15 Service, maintenance and warranty

Maintenance of the micro annular gear pump should be carried out depending on the delivered liquid:

- *for lubricating liquids* after 6000 working hours, but not later than 15 months after the initial operation
- *for non-lubricating liquids, crystallizing liquids or liquids containing particles*, after 4000 working hours but not later than 12 months after the initial operation. If during the first inspection no substantial wearout of the pump is observed, the following inspection under the same working conditions should be performed after 6000 working hours, yet not later than 15 months following to the last inspection.

If during the first inspection the pump shows a particularly strong wearout, the maintenance intervals should be readapted to the changing operating parameters.

In order to prevent a strong wearout of the pump, the pump should be shut down properly after every application as described in the chapter 7.3. A supplementary flushing procedure with a neutral flushing liquid (see chapter 7.3) also slows down the wearout process of the pump.



It is not allowed to open or dismantle the micro annular gear pumps. The warranty extinguishes with the expiry of the legal warranty period or with the opening of the pump. Furthermore HNP Mikrosysteme cannot give any warranty of exchange for parts whose damage result from incorrect use.



For service and maintenance please return your micro annular gear pump to HNP Mikrosysteme. You will find the address on the cover of the present operating manual.



The declaration of media (liquids) having had contact with the micro annular gear pump and components must imperatively be completed. The nature of media (liquids) must be specified. In case of non-compliance the sender will be liable for any resulting injury to persons or any object damage.



Sealing elements, rotors and shaft are parts that undergo wear and will be replaced by HNP Mikrosysteme GmbH during maintenance depending on their degree of wear.

## 16 Contact person

### **Development and application assistance, service and accessories**

Mr. Sven Reimann  
Phone +49| (0) 385|52190-349

### **Service and maintenance**

Mr. Steffen Edler  
Phone +49| (0) 385|52190-307

### **Drive and control technology**

Mr. Lutz Nowotka  
Phone +49| (0) 385|52190-346



## 17 Legal information

### Marks

Kalrez® Spectrum™ is a registered trademark of DuPont.

PEEK™ is a registered trademark of Victrex plc.

Teflon® is a registered trademark of DuPont.

Viton® is a registered trademark of DuPont Dow Elastomers.

HASTELLOY® is a registered trademark of Haynes International, Inc.

Aflas® is a registered trademark of ASAHI Glass Ltd.

Microsoft®, Windows® are registered trademarks of Microsoft Corporation in the USA and in the other countries.

mzs®, MoDoS®, µ-Clamp® are registered German trademarks of HNP Mikrosysteme GmbH.

Other product names or descriptions not mentioned above are possibly registered trademarks of related companies.

### Patents

Micro annular gear pumps (and housings) are protected by assigned patents: DE 198 43 161 C2, EP 1115979 B1, US 6,520,757 B1, EP 852674 B1, US 6,179,596 B1, EP 1354135, US 7,698,818 B2. Patents pending: EP 1807546, DE 10 2009 020 942.5-24, DE 10 2011 001 041.6. In the US, Europe and Japan additional patents are pending.

## 18 Safety information for the return of already employed micro annular gear pumps and components

### 18.1 General information

The operator carries the responsibility for health and safety of his/her employees. The responsibility extends also to employees not belonging to the company that have a direct contact with the micro annular gear pump and its components during repair or maintenance works. The nature of media (liquids) coming into contact with the micro annular gear pump and its components must be specified in the corresponding declaration form.

### 18.2 Declaration of media in contact with the micro annular gear pump

The staff performing the repair or maintenance works must be informed about the condition of the micro annular gear pump before starting any work on the device. The "Declaration of media in contact with the micro annular gear pump" should be filled in for this purpose.

The declaration should be sent directly to the supplier or to the company designated by the supplier. A second copy of the declaration must be attached to the shipment documents.

### 18.3 Shipment

The following instructions should be observed for the shipment of the micro annular gear pump.

- drain the pump from any remaining liquid
- flush the pump with an adapted flushing liquid
- remove the filter elements from the integrated or loosely delivered filters
- all the openings should be air-tight plugged
- return the pump in the original packing

## 19 Declaration of media in contact with the micro annular gear pump and its components

### Type of the device

Pump type/serial number/article no.: \_\_\_\_\_

Operating hours/running time: \_\_\_\_\_

Number of delivery note or delivery date: \_\_\_\_\_

Reason of return: \_\_\_\_\_

\_\_\_\_\_

\_\_\_\_\_

### Contact with media (liquids)

The micro annular gear pump was in contact with:

\_\_\_\_\_

and has been rinsed with:

\_\_\_\_\_

Product info sheet / Material Safety Data Sheet:  yes\*  no

\* Please attach file

or is available on the following web site: www. \_\_\_\_\_

If a pump which had contact with dangerous substances could not be properly cleansed prior to shipment, we reserve the right to entrust a specialized company with cleansing of the device. The return of the pump in original packing is advisable. It is necessary in order to protect the employees and delivery staff.

Nature of media contact:

explosive

oxidizing

sensitive to moisture

toxic (toxic byproducts)

radioactive

pH-value: approx. \_\_\_\_\_ to \_\_\_\_\_

carcinogenic

microbiological

other: \_\_\_\_\_

irritant

corrosive

\_\_\_\_\_

R-statements: \_\_\_\_\_ S-statements: \_\_\_\_\_

### Declaration

Hereby I/we affirm that the stated information is complete and correct. Micro annular gear pump and accessories are shipped in conformity with the applicable regulations.

company: \_\_\_\_\_  Mrs  Mr title: \_\_\_\_\_

division: \_\_\_\_\_ name: \_\_\_\_\_

street, no.: \_\_\_\_\_ phone: \_\_\_\_\_

ZIP/city: \_\_\_\_\_ e-mail: \_\_\_\_\_

country: \_\_\_\_\_

city, date: \_\_\_\_\_ authorized signature /

company stamp:

## 20 Appendix

- Layouts
- Operating manual for the S-KD control unit
- Operating manual for the S-KG control unit (optional)
- Operating manual for the S-BL control unit (optional)

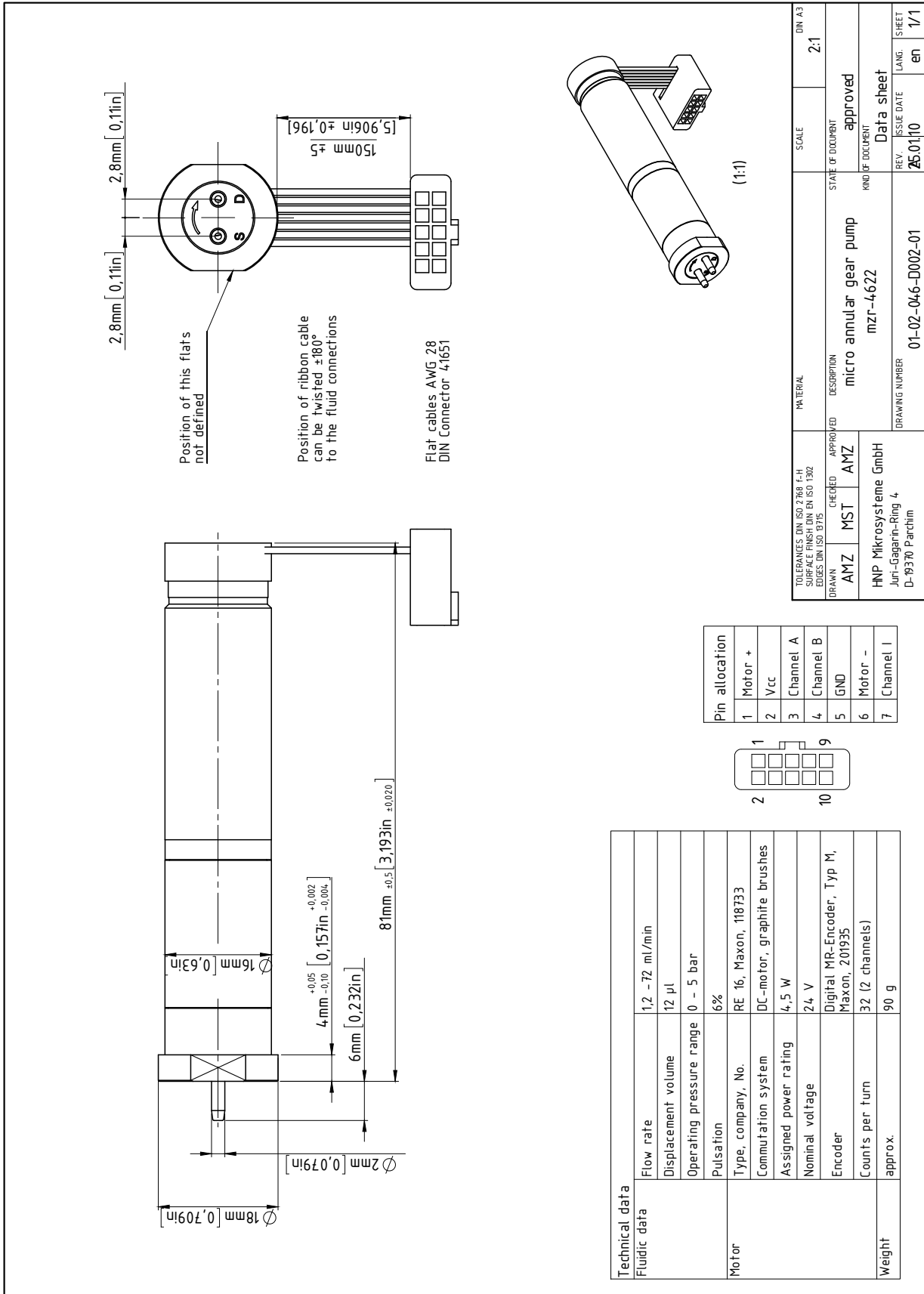

figure 38 Data sheet of the micro annular gear pump mzt-4622

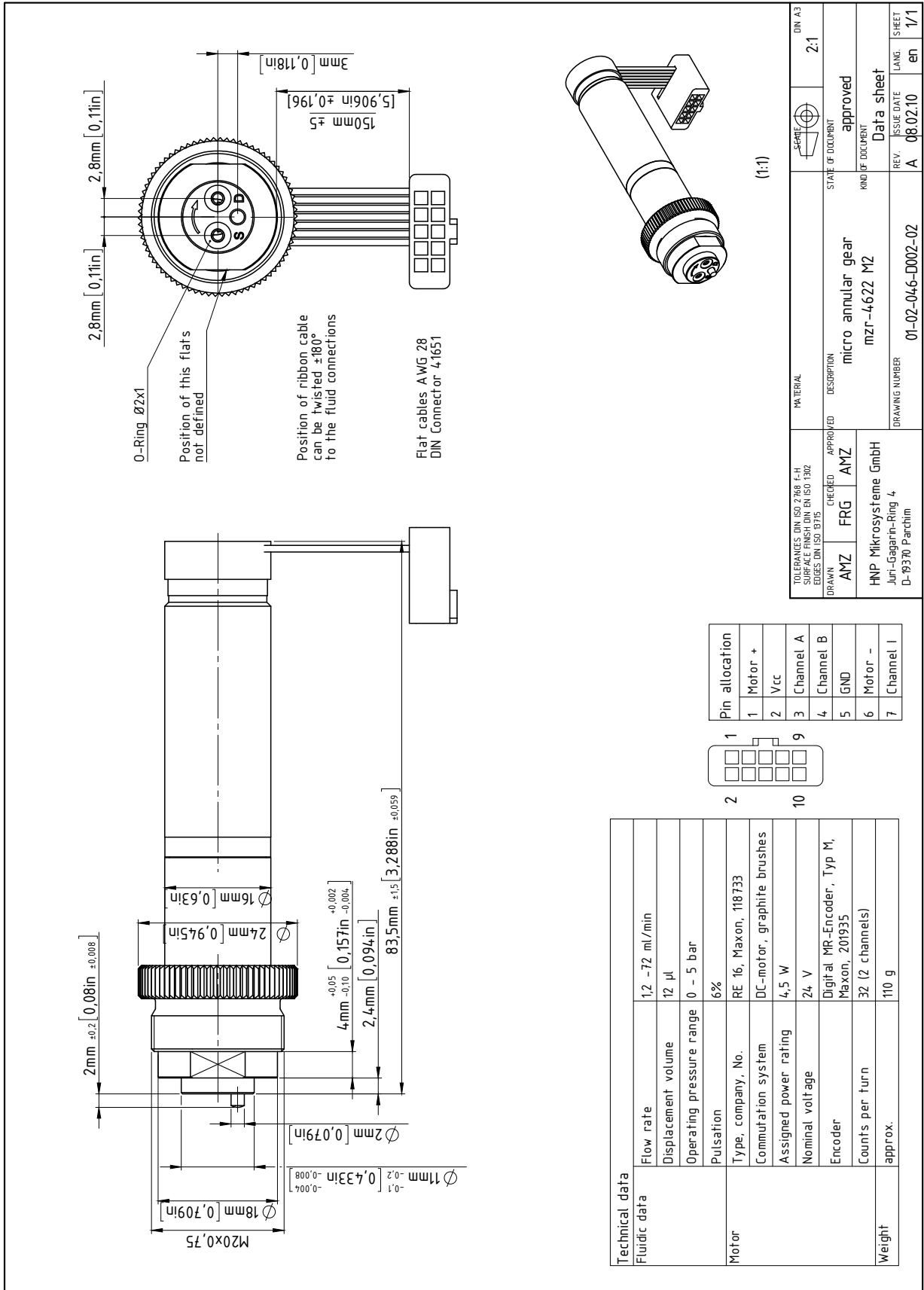

figure 39 Data sheet of the micro annular gear pump mzs-4622 M2

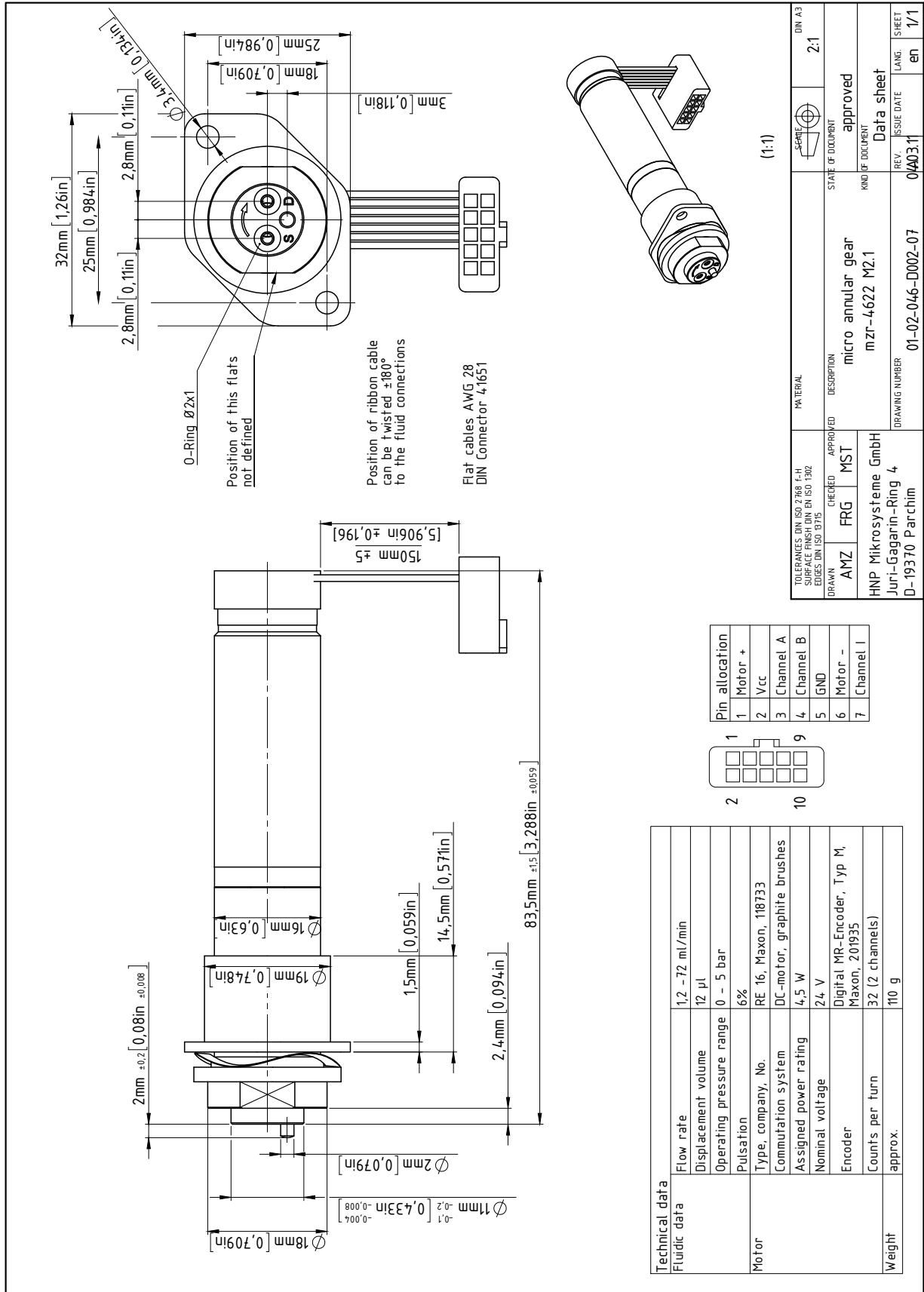

figure 40 Data sheet of the micro annular gear pump mZR-4622 M2.1

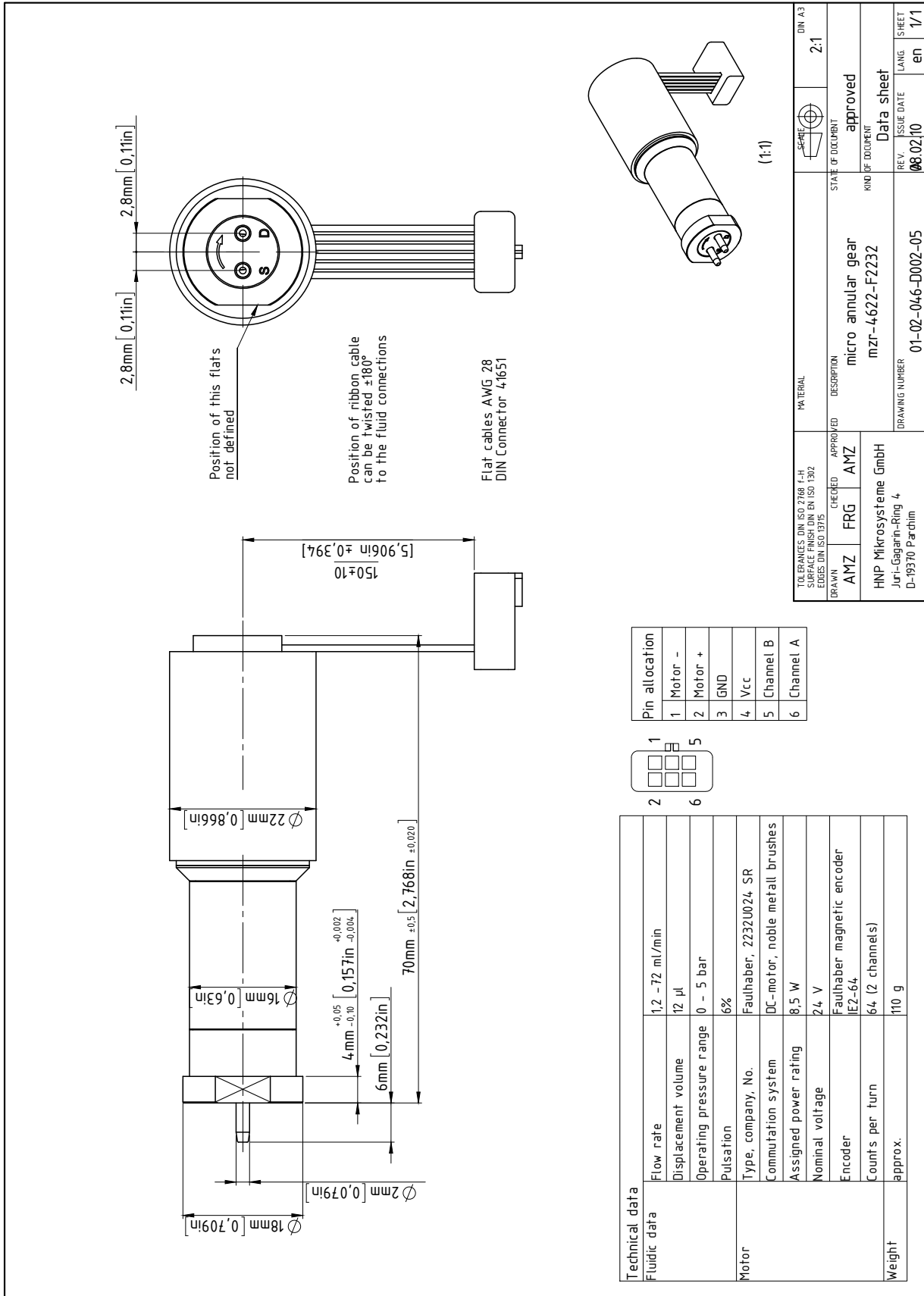

figure 41

Data sheet of the micro annular gear pump mzs-4622 with high torque motor



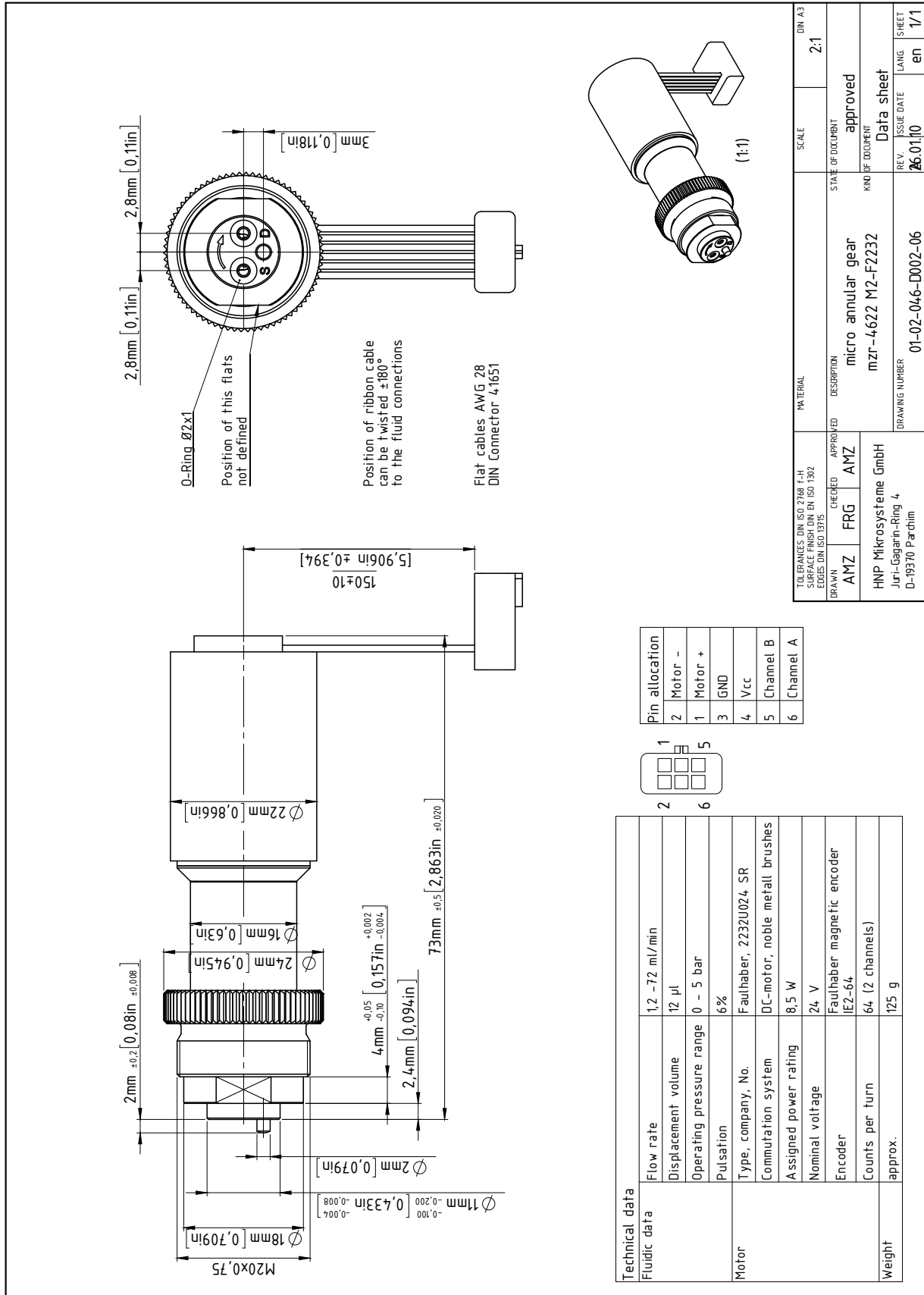

figure 42

Data sheet of the micro annular gear pump mzs-4622 M2 with high torque motor

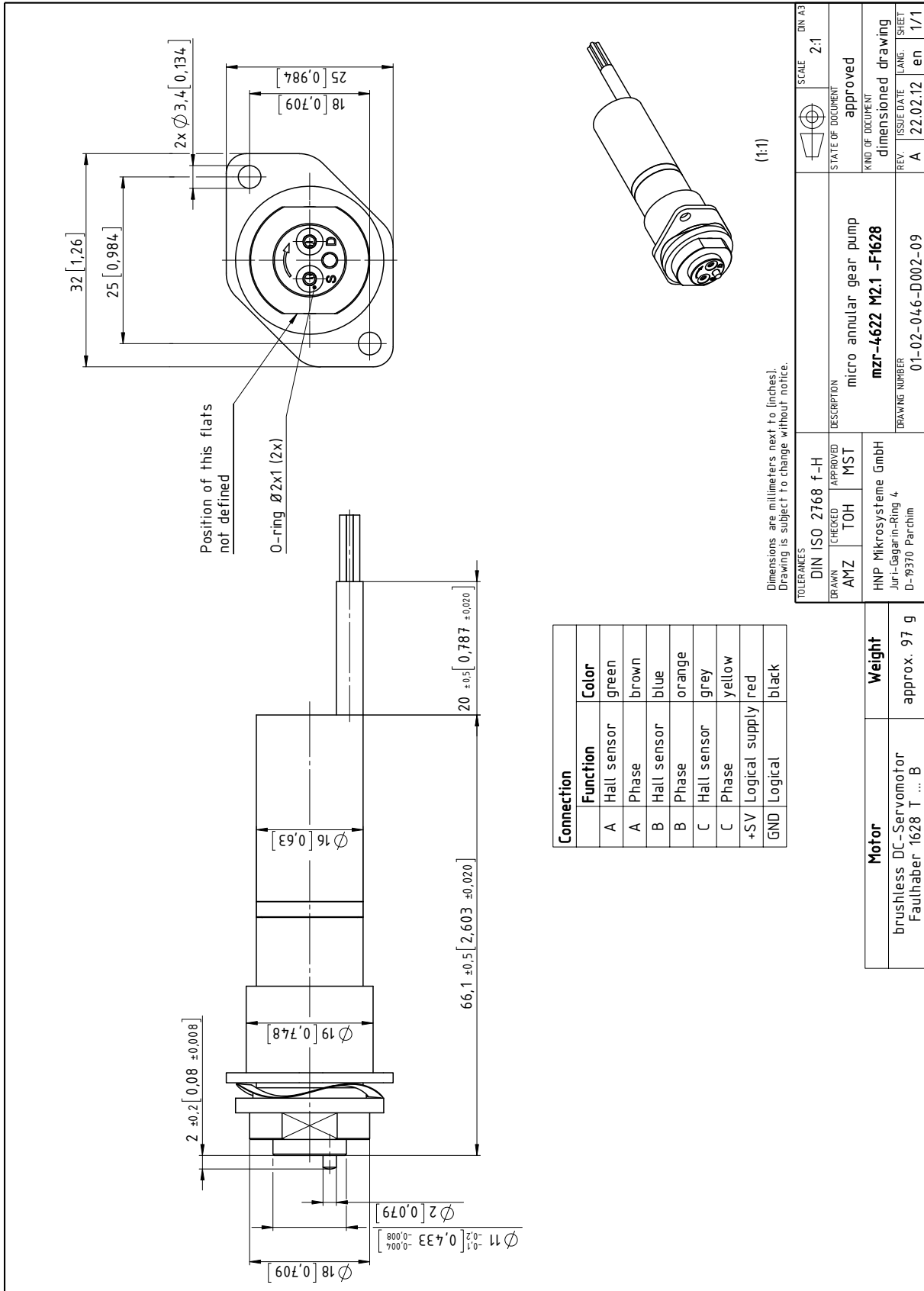

figure 43

Data sheet of the micro annular gear pump mzs-4622 with brushless DC-motor